

ARM v7-M Architecture Application Level Reference Manual

Beta

ARM[®]

ARM v7-M Architecture Application Level Reference Manual

Copyright © 2006 ARM Limited. All rights reserved.

Release Information

The following changes have been made to this document.

Change History

Date	Issue	Change
21-Mar-2006	A	first beta release

Proprietary Notice

ARM, the ARM Powered logo, Thumb, and StrongARM are registered trademarks of ARM Limited.

The ARM logo, AMBA, Angel, ARMulator, EmbeddedICE, ModelGen, Multi-ICE, PrimeCell, ARM7TDMI, ARM7TDMI-S, ARM9TDMI, ARM9E-S, ETM7, ETM9, TDMI, STRONG, are trademarks of ARM Limited.

All other products or services mentioned herein may be trademarks of their respective owners.

The product described in this document is subject to continuous developments and improvements. All particulars of the product and its use contained in this document are given by ARM in good faith.

1. Subject to the provisions set out below, ARM hereby grants to you a perpetual, non-exclusive, nontransferable, royalty free, worldwide licence to use this ARM Architecture Reference Manual for the purposes of developing; (i) software applications or operating systems which are targeted to run on microprocessor cores distributed under licence from ARM; (ii) tools which are designed to develop software programs which are targeted to run on microprocessor cores distributed under licence from ARM; (iii) integrated circuits which incorporate a microprocessor core manufactured under licence from ARM.

2. Except as expressly licensed in Clause 1 you acquire no right, title or interest in the ARM Architecture Reference Manual, or any Intellectual Property therein. In no event shall the licences granted in Clause 1, be construed as granting you expressly or by implication, estoppel or otherwise, licences to any ARM technology other than the ARM Architecture Reference Manual. The licence grant in Clause 1 expressly excludes any rights for you to use or take into use any ARM patents. No right is granted to you under the provisions of Clause 1 to: (i) use the ARM Architecture Reference Manual for the purposes of developing or having developed microprocessor cores or models thereof which are compatible in whole or part with either or both the instructions or programmer's models described in this ARM Architecture Reference Manual; or (ii) develop or have developed models of any microprocessor cores designed by or for ARM; or (iii) distribute in whole or in part this ARM Architecture Reference Manual to third parties without the express written permission of ARM; or (iv) translate or have translated this ARM Architecture Reference Manual into any other languages.

3. THE ARM ARCHITECTURE REFERENCE MANUAL IS PROVIDED "AS IS" WITH NO WARRANTIES EXPRESS, IMPLIED OR STATUTORY, INCLUDING BUT NOT LIMITED TO ANY WARRANTY OF SATISFACTORY QUALITY, NONINFRINGEMENT OR FITNESS FOR A PARTICULAR PURPOSE.

4. No licence, express, implied or otherwise, is granted to LICENSEE, under the provisions of Clause 1, to use the ARM tradename, in connection with the use of the ARM Architecture Reference Manual or any products based thereon. Nothing in Clause 1 shall be construed as authority for you to make any representations on behalf of ARM in respect of the ARM Architecture Reference Manual or any products based thereon.

Copyright © 2005, 2006 ARM limited

110 Fulbourn Road Cambridge, England CB1 9NJ

Restricted Rights Legend: Use, duplication or disclosure by the United States Government is subject to the restrictions set forth in DFARS 252.227-7013 (c)(1)(ii) and FAR 52.227-19

The right to use and copy this document is subject to the licence set out above.

Contents

ARM v7-M Architecture Application Level Reference Manual

Preface

About this manual	x
Unified Assembler Language	xi
Using this manual	xii
Conventions	xiv
Further reading	xv
Feedback	xvi

Part A Application

Chapter A1

Introduction

A1.1 The ARM Architecture – M profile	A1-2
A1.2 Introduction to Pseudocode	A1-3

Chapter A2

Application Level Programmer's Model

A2.1 The register model	A2-2
A2.2 Exceptions, faults and interrupts	A2-5
A2.3 Coprocessor support	A2-6

Chapter A3	ARM Architecture Memory Model	
A3.1	Address space	A3-2
A3.2	Alignment Support	A3-3
A3.3	Endian Support	A3-5
A3.4	Synchronization and semaphores	A3-8
A3.5	Memory types	A3-19
A3.6	Access rights	A3-26
A3.7	Memory access order	A3-27
A3.8	Caches and memory hierarchy	A3-32
A3.9	Bit banding	A3-34

Chapter A4	The Thumb Instruction Set	
A4.1	Instruction set encoding	A4-2
A4.2	Instruction encoding for 16-bit Thumb instructions	A4-3
A4.3	Instruction encoding for 32-bit Thumb instructions	A4-12
A4.4	Conditional execution	A4-33
A4.5	UNDEFINED and UNPREDICTABLE instruction set space	A4-37
A4.6	Usage of 0b1111 as a register specifier	A4-39
A4.7	Usage of 0b1101 as a register specifier	A4-41

Chapter A5	Thumb Instructions	
A5.1	Format of instruction descriptions	A5-2
A5.2	Immediate constants	A5-8
A5.3	Constant shifts applied to a register	A5-10
A5.4	Memory accesses	A5-13
A5.5	Memory hints	A5-14
A5.6	NOP-compatible hints	A5-15
A5.7	Alphabetical list of Thumb instructions	A5-16

Part B System

Chapter B1	System Level Programmer's Model	
B1.1	Introduction to the system level	B1-2
B1.2	System programmer's model	B1-3

Chapter B2	System Address Map	
B2.1	The system address map	B2-2
B2.2	Bit Banding	B2-5
B2.3	System Control Space (SCS)	B2-7
B2.4	System timer - SysTick	B2-9
B2.5	Nested Vectored Interrupt Controller (NVIC)	B2-10
B2.6	Protected Memory System Architecture	B2-12

Chapter B3	ARMv7-M System Instructions	
B3.1	Alphabetical list of ARMv7-M system instructions	B3-2

Part C**Debug****Chapter C1****Debug**

C1.1	Introduction to debug	C1-2
C1.2	The Debug Access Port (DAP)	C1-4
C1.3	Overview of the ARMv7-M debug features	C1-7
C1.4	Debug and reset	C1-8
C1.5	Debug event behavior	C1-9
C1.6	Debug register support in the SCS	C1-11
C1.7	Instrumentation Trace Macrocell (ITM) support	C1-12
C1.8	Data Watchpoint and Trace (DWT) support	C1-14
C1.9	Embedded Trace (ETM) support	C1-15
C1.10	Trace Port Interface Unit (TPIU)	C1-16
C1.11	Flash Patch and Breakpoint (FPB) support	C1-17

Appendix A**Pseudo-code definition**

A.1	Instruction encoding diagrams and pseudo-code	AppxA-2
A.2	Data Types	AppxA-4
A.3	Expressions	AppxA-8
A.4	Operators and built-in functions	AppxA-10
A.5	Statements and program structure	AppxA-18
A.6	Helper procedures and functions	AppxA-22

Appendix B**Legacy Instruction Mnemonics****Appendix C****CPUID**

C.1	Core Feature ID Registers	AppxC-2
-----	---------------------------------	---------

Appendix D**Deprecated Features in ARMv7M****Glossary**

Preface

This preface describes the contents of this manual, then lists the conventions and terminology it uses.

- *About this manual* on page x
- *Unified Assembler Language* on page xi
- *Using this manual* on page xii
- *Conventions* on page xiv
- *Further reading* on page xv
- *Feedback* on page xvi.

About this manual

This manual documents the Microcontroller profile associated with version 7 of the ARM Architecture (ARMv7-M). For short-form definitions of all the ARMv7 profiles see page A1-1.

The manual consists of three parts:

Part A The application level programming model and memory model information along with the instruction set as visible to the application programmer.

This is the information required to program applications or to develop the toolchain components (compiler, linker, assembler and disassembler) excluding the debugger. For ARMv7-M, this is almost entirely a subset of material common to the other two profiles. Instruction set details which differ between profiles are clearly stated.

———— **Note** —————

All ARMv7 profiles support a common procedure calling standard, the ARM Architecture Procedure Calling Standard (AAPCS).

Part B The system level programming model and system level support instructions required for system correctness. The system level supports the ARMv7-M exception model. It also provides features for configuration and control of processor resources and management of memory access rights.

This is the information in addition to Part A required for an operating system (OS) and/or system support software. It includes details of register banking, the exception model, memory protection (management of access rights) and cache support.

Part B is profile specific. ARMv7-M introduces a new programmer's model and as such has some fundamental differences at the system level from the other profiles. As ARMv7-M is a memory-mapped architecture, the system memory map is documented here.

Part C The debug features to support the ARMv7-M debug architecture, and the programmer's interface to the debug environment.

This is the information required in addition to Parts A and B to write a debugger. Part C covers details of the different types of debug:

- halting debug and the related debug state
- exception-based monitor debug
- non-invasive support for event generation and signalling of the events to an external agent.

This part is profile specific and includes several debug features unique within the ARMv7 architecture to this profile.

Unified Assembler Language

Unified Assembler Language (UAL) provides a canonical form for all ARM and Thumb instructions. This replaces the earlier Thumb assembler language.

The syntax of Thumb instructions is now the same as the syntax of ARM instructions. For details on the changes from the old Thumb syntax, see page AppxB-1.

UAL describes the syntax for the mnemonic and the operands of each instruction. In addition, it assumes that instructions and data items can be given labels. It does not specify the syntax to be used for labels, nor what assembler directives and options are available. See your assembler documentation for these details.

UAL includes *instruction selection* rules that specify which instruction encoding is selected when more than one can provide the required functionality. For example, both 16-bit and 32-bit encodings exist for an `ADD R0, R1, R2` instruction.

The most common instruction selection rule is that when both a 16-bit encoding and a 32-bit encoding are available, the 16-bit encoding is selected, to optimize code density.

Syntax options exist to override the normal instruction selection rules and ensure that a particular encoding is selected. These are useful when disassembling code, to ensure that subsequent assembly produces the original code, and in some other situations.

———— **Note** —————

The precise effects of each instruction are described, including any restrictions on its use. This information is of primary importance to authors of compilers, assemblers, and other programs that generate Thumb machine code.

This manual is restricted to UAL and not intended as tutorial material for ARM assembler language, nor does it describe ARM assembler language at anything other than a very basic level. To make effective use of ARM assembler language, consult the documentation supplied with the assembler being used. Different assemblers vary considerably with respect to many aspects of assembler language, such as which assembler directives are accepted and how they are coded.

Assembler syntax is given for the instructions described in this manual, allowing instructions to be specified in textual form. This is of considerable use to assembly code writers, and also when debugging either assembler or high-level language code at the single instruction level.

Using this manual

The information in this manual is organized into nine chapters and a set of supporting appendices, as described below:

Chapter A1 Introduction

ARMv7 overview, the different architecture profiles and the background to the Microcontroller (M) profile.

Chapter A2 Application Level Programmer's Model

Details on the registers and status bits available at the application level along with a summary of the exception support.

Chapter A3 ARM Architecture Memory Model

Details of the ARM architecture memory attributes and memory order model.

Chapter A4 The Thumb Instruction Set

Encoding diagrams for the Thumb instruction set along with general details on bit field usage, UNDEFINED and UNPREDICTABLE terminology.

Chapter A5 Thumb Instructions

Contains detailed reference material on each Thumb instruction, arranged alphabetically by instruction mnemonic. Summary information for system instructions is included and referenced for detailed definition in Part B.

Chapter B1 System Level Programmer's Model

Details of the registers, status and control mechanisms available at the system level.

Chapter B2 System Address Map

Overview of the system address map, and details of the architecturally defined features within the Private Peripheral Bus region. This chapter includes details of the memory-mapped support for a protected memory system.

Chapter B3 ARMv7-M System Instructions

Contains detailed reference material on the system level instructions.

Chapter C1 Debug

ARMv7-M debug support

Appendix A Pseudo-code definition

Definition of terms, format and helper functions used by the pseudo-code to describe the memory model and instruction operations

Appendix B Legacy Instruction Mnemonics

A cross reference of Unified Assembler Language forms of the instruction syntax to the Thumb format used in earlier versions of the ARM architecture.

Appendix C CPUID

A summary of the ID attribute registers used for ARM architecture feature identification.

Appendix D *Deprecated Features in ARMv7M*

Deprecated features that software is advised to avoid for future-proofing. It is ARM's intent to remove this functionality in a future version of the ARM architecture.

Glossary Glossary of terms - not including those associated with pseudo-code.

Conventions

This manual employs typographic and other conventions intended to improve its ease of use.

General typographic conventions

<code>typewriter</code>	Is used for assembler syntax descriptions, pseudo-code descriptions of instructions, and source code examples. For more details of the conventions used in assembler syntax descriptions see <i>Assembler syntax</i> on page A5-3. For more details of pseudo-code conventions see Appendix A <i>Pseudo-code definition</i> . The <code>typewriter</code> font is also used in the main text for instruction mnemonics and for references to other items appearing in assembler syntax descriptions, pseudo-code descriptions of instructions and source code examples.
<i>italic</i>	Highlights important notes, introduces special terminology, and denotes internal cross-references and citations.
bold	Is used for emphasis in descriptive lists and elsewhere, where appropriate.
SMALL CAPITALS	Are used for a few terms which have specific technical meanings.

Further reading

This section lists publications that provide additional information on the ARM family of processors. This manual provides architecture information. It is designed to be read in conjunction with a Technical Reference Manual (TRM) for the implementation of interest. The TRM provides details of the IMPLEMENTATION DEFINED architecture features in the ARM compliant core. The silicon partner's device specification should be used for additional system details.

ARM periodically provides updates and corrections to its documentation. For the latest information and errata, some materials are published at <http://www.arm.com>. Alternatively, contact your distributor or silicon partner who will have access to the latest published ARM information, as well as information specific to the device of interest.

ARM publications

The first ARMv7-M implementation is described in the *Cortex-M3 Technical Reference Manual* (ARM DDI 0337).

Feedback

ARM Limited welcomes feedback on its documentation.

Feedback on this book

If you notice any errors or omissions in this book, send email to errata@arm.com giving:

- the document title
- the document number
- the page number(s) to which your comments apply
- a concise explanation of the problem.

General suggestions for additions and improvements are also welcome.

Part A

Application

Chapter A1

Introduction

Due to the explosive growth in recent years associated with the ARM architecture into many market areas, along with the need to maintain high levels of architecture consistency, ARMv7 is documented as a set of architecture profiles. The ARM architecture specification is re-structured accordingly. Three profiles have been defined as follows:

- ARMv7-A** the application profile for systems supporting the ARM and Thumb instruction sets, and requiring virtual address support in the memory management model.
- ARMv7-R** the realtime profile for systems supporting the ARM and Thumb instruction sets, and requiring physical address only support in the memory management model
- ARMv7-M** the microcontroller profile for systems supporting only the Thumb instruction set, and where overall size and deterministic operation for an implementation are more important than absolute performance.

While profiles were formally introduced with the ARMv7 development, the A-profile and R-profile have implicitly existed in earlier versions, associated with the Virtual Memory System Architecture (VMSA) and Protected Memory System Architecture (PMSA) respectively.

Instruction Set Architecture (ISA)

ARMv7-M only supports Thumb instructions, and specifically a subset of the ARMv7 Thumb-2 instruction set, where Thumb-2 indicates general support of both 16-bit and 32-bit instructions in the Thumb execution state.

A1.1 The ARM Architecture – M profile

The ARM architecture has evolved through several major revisions to a point where it supports implementations across a wide spectrum of performance points, with over a billion parts per annum being produced. The latest version (ARMv7) has seen the diversity formally recognised in a set of architecture profiles, the profiles used to tailor the architecture to different market requirements. A key factor is that the application level is consistent across all profiles, and the bulk of the variation is at the system level.

The introduction of Thumb-2 in ARMv6T2 provided a balance to the ARM and Thumb instruction sets, and the opportunity for the ARM architecture to be extended into new markets, in particular the microcontroller marketplace. To take maximum advantage of this opportunity a Thumb-only profile with a new programmer's model (a system level consideration) has been introduced as a unique profile, complementing ARM's strengths in the high performance and real-time embedded markets.

Key criteria for ARMv7-M implementations are as follows:

- Enable implementations with industry leading power, performance and area constraints
 - Opportunities for simple pipeline designs offering leading edge system performance levels in a broad range of markets and applications
- Highly deterministic operation
 - Single/low cycle execution
 - Minimal interrupt latency (short pipelines)
 - Cacheless operation
- Excellent C/C++ target – aligns with ARM's programming standards in this area
 - Exception handlers are standard C/C++ functions, entered using standard calling conventions
- Designed for deeply embedded systems
 - Low pincount devices
 - Enable new entry level opportunities for the ARM architecture
- Debug and software profiling support for event driven systems

This manual is specific to the ARMv7-M profile.

A1.2 Introduction to Pseudocode

Pseudo-code is used to describe the exception model, memory system behaviour, and the instruction set architecture. The general format rules for pseudo-code used throughout this manual are described in Appendix A *Pseudo-code definition*. This appendix includes information on data types and the operations (logical and arithmetic) supported by the ARM architecture.

Chapter A2

Application Level Programmer's Model

This chapter provides an application level view of the programmer's model. This is the information necessary for application development, as distinct from the system information required to service and support application execution under an operating system. It contains the following sections:

- *The register model* on page A2-2
- *Exceptions, faults and interrupts* on page A2-5
- *Coprocessor support* on page A2-6

System related information is provided in overview form and/or with references to the system information part of the architecture specification as appropriate.

A2.1 The register model

The application level programmer's model provides details of the general-purpose and special-purpose registers visible to the application programmer, the ARM memory model, and the instruction set used to load to registers from memory, store registers to memory, or manipulate data (data operations) within the registers.

Applications often interact with external events. A summary of the types of events recognized in the architecture, along with the mechanisms provided in the architecture to interact with events, is included in *Exceptions, faults and interrupts* on page A2-5). How events are handled is a system level topic described in *Exception model* on page B1-9.

A2.1.1 Registers

There are thirteen general-purpose 32-bit registers (R0-R12), and an additional three 32-bit registers which have special names and usage models.

SP stack pointer (R13), used as a pointer to the active stack. For usage restrictions see Chapter A5 *Thumb Instructions*. This is preset to the top of the Main stack on reset. See *The SP registers* on page B1-7 for additional information.

LR link register (R14), used to store a value (the Return Link) relating to the return address from a subroutine which is entered using a Branch with Link instruction. This register is set to an illegal value (all 1's) on reset. The reset value will cause a fault condition to occur if a subroutine return call is attempted from it.

PC program counter. For details on the usage model of the PC see Chapter A5 *Thumb Instructions*. The PC is loaded with the Reset handler start address on reset.

Program status is reported in the 32-bit Application Program Status Register (APSR), where the defined bits break down into a set of flags as follows:

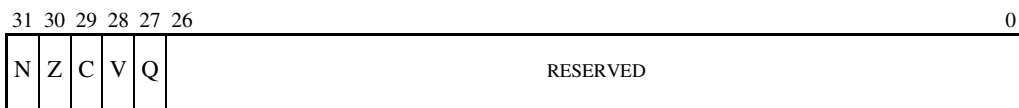

APSR bit fields fall into two categories

- Reserved bits are allocated to system features or are available for future expansion. Further information on currently allocated reserved bits is available in *The special-purpose processor status registers (xPSR)* on page B1-7. Software must ignore values read from reserved bits, and preserve their value on a write, to ensure future compatibility. The bits are defined as SBZP/UNP.
- User-writeable bits NZCVQ, collectively known as the flags

NZCV (the Negative, Zero, Carry and oVerflow flags) are sometimes referred to as the condition code flags, and are written on execution of a flag-setting instruction:

- N is set to bit<31> of the result of the instruction. If this result is regarded as a two's complement signed integer, then N = 1 if the result is negative and N = 0 if the result is positive or zero.

- Z is set if the result of the instruction is zero, otherwise it is cleared.
- C is set in one of four ways on an instruction:
 - For an addition, including the comparison instruction CMN, C is set if the addition produced a carry (that is, an unsigned overflow), otherwise it is cleared.
 - For a subtraction, including the comparison instruction CMP, C is cleared if the subtraction produced a borrow (that is, an unsigned underflow), otherwise it is set.
 - For non-additions/subtractions that include a shift, C is set or cleared to the last bit shifted out of the value by the shifter.
 - For other non-additions/subtractions, C is normally unchanged (special cases are listed as part of the instruction definition).
- V is set in one of two ways on an instruction:
 - For an addition or subtraction, V is set if a signed overflow occurred, regarding the operands and result as two's complement signed integers
 - For non-additions/subtractions, V is normally unchanged (special cases are listed as part of the instruction definition).

The Q flag is set if the result of an SSAT, SSAT16, USAT or USAT16 instruction changes (saturates) the input value for the signed or unsigned range of results.

A2.1.2 Execution state support

ARMv7-M only executes Thumb instructions, and therefore always executes instructions in Thumb state. See Chapter A5 *Thumb Instructions* for a list of the instructions supported.

In addition to normal program execution, there is a Debug state – see Chapter C1 *Debug* for more details.

A2.1.3 Privileged execution

Good system design practice requires the application developer to have a degree of knowledge of the underlying system architecture and the services it offers. System support requires a level of access generally referred to as privileged operation. The system support code determines whether applications run in a privileged or unprivileged manner. Where both privileged and unprivileged support is provided by an operating system, applications usually run unprivileged, allowing the operating system to allocate system resources for sole or shared use by the application, and to provide a degree of protection with respect to other processes and tasks.

Thread mode is the fundamental mode for application execution in ARMv7-M. Thread mode is selected on reset, and can execute in a privileged or non-privileged manner depending on the system environment. Privileged execution is required to manage system resources in many cases. When code is executing unprivileged, Thread mode can execute an SVC instruction to generate a supervisor call exception. Privileged execution in Thread mode can raise a supervisor call using SVC or handle system access and control directly.

All exceptions execute as privileged code in Handler mode. See *Exception model* on page B1-9 for details. Supervisor call handlers manage resources on behalf of the application such as memory allocation and management of software stacks.

A2.2 Exceptions, faults and interrupts

An exception can be caused by the execution of an exception generating instruction or triggered as a response to a system behavior such as an interrupt, memory management, alignment or bus fault, or a debug event. Synchronous and asynchronous exceptions can occur within the architecture.

A2.2.1 System related events

The following types of exception are system related. Where there is direct correlation with an instruction, reference to the associated instruction is made.

Supervisor calls are used by application code to request a service from the underlying operating system. Using the *SVC* instruction, the application can instigate a supervisor call for a service requiring privileged access to the system.

Several forms of Fault can occur:

- Instruction execution related errors
- Data memory access errors can occur on any load or store
- Usage faults from a variety of execution state related errors. Execution of an *UNDEFINED* instruction is an example cause of a *UsageFault* exception.
- Debug events can generate a *DebugMonitor* exception.

Faults in general are synchronous with respect to the associated executing instruction. Some system errors can cause an imprecise exception where it is reported at a time bearing no fixed relationship to the instruction which caused it.

Interrupts are always treated as asynchronous events with respect to the program flow. System timer (*SysTick*), a pended service call (*PendSV*), and an external interrupt controller (*NVIC*) are all defined.

A *BKPT* instruction generates a debug event – see *Debug event behavior* on page C1-9 for more information.

For power or performance reasons it can be desirable to either notify the system that an action is complete, or provide a hint to the system that it can suspend operation of the current task. Instruction support is provided for the following:

- Send Event and Wait for Event instructions. See *WFE* on page A5-317.
- Wait For Interrupt. See *WFI* on page A5-319.

A2.3 Coprocessor support

An ARMv7-M implementation can optionally support coprocessors. If it does not support them, it treats all coprocessors as non-existent. Coprocessors 8 to 15 (CP8 to CP15) are reserved by ARM. Coprocessors 0 to 7 (CP0 to CP7) are IMPLEMENTATION DEFINED, subject to the coprocessor instruction constraints of the instruction set architecture.

Where a coprocessor instruction is issued to a non-existent or disabled coprocessor, a NOCP UsageFault is generated (see *Fault behavior* on page B1-14).

Unknown instructions issued to an enabled coprocessor generate an UNDEFINSTR UsageFault.

Chapter A3

ARM Architecture Memory Model

This chapter covers the general principles which apply to the ARM memory model. The chapter contains the following sections:

- *Address space* on page A3-2
- *Alignment Support* on page A3-3
- *Endian Support* on page A3-5
- *Synchronization and semaphores* on page A3-8
- *Memory types* on page A3-19
- *Access rights* on page A3-26
- *Memory access order* on page A3-27
- *Caches and memory hierarchy* on page A3-32

ARMv7-M is a memory-mapped architecture. The address map specific details that apply to ARMv7-M are described in *The system address map* on page B2-2. The chapter includes one feature unique to the M profile:

- *Bit banding* on page A3-34

A3.1 Address space

The ARM architecture uses a single, flat address space of 2^{32} 8-bit bytes. Byte addresses are treated as unsigned numbers, running from 0 to $2^{32} - 1$.

This address space is regarded as consisting of 2^{30} 32-bit words, each of whose addresses is word-aligned, which means that the address is divisible by 4. The word whose word-aligned address is A consists of the four bytes with addresses A, A+1, A+2 and A+3. The address space can also be considered as consisting of 2^{31} 16-bit halfwords, each of whose addresses is halfword-aligned, which means that the address is divisible by 2. The halfword whose halfword-aligned address is A consists of the two bytes with addresses A and A+1.

While instruction fetches are always halfword-aligned, some load and store instructions support unaligned addresses. This affects the access address A, such that A<1:0> in the case of a word access and A<0> in the case of a halfword access can have non-zero values.

Address calculations are normally performed using ordinary integer instructions. This means that they normally wrap around if they overflow or underflow the address space. This means that the result of the calculation is reduced modulo 2^{32} .

Normal sequential execution of instructions effectively calculates:

```
(address_of_current_instruction) +(2 or 4) /*16- and 32-bit instr mix*/
```

after each instruction to determine which instruction to execute next. If this calculation overflows the top of the address space, the result is UNPREDICTABLE. In ARMv7-M this condition cannot occur because the top of memory is defined to always have the eXecute Never (XN) memory attribute associated with it. See *The system address map* on page B2-2 for more details. An access violation will be reported if this scenario occurs.

The above only applies to instructions that are executed, including those which fail their condition code check. Most ARM implementations prefetch instructions ahead of the currently-executing instruction.

LDC, LDM, LDRD, POP, PUSH, STC, STRD, and STM instructions access a sequence of words at increasing memory addresses, effectively incrementing a memory address by 4 for each register load or store. If this calculation overflows the top of the address space, the result is UNPREDICTABLE.

Any unaligned load or store whose calculated address is such that it would access the byte at 0xFFFFFFFF and the byte at address 0x00000000 as part of the instruction is UNPREDICTABLE.

A3.1.1 Virtual versus Physical Addressing

Virtual memory is not supported in ARMv7-M.

A3.2 Alignment Support

The system architecture can choose one of two policies for alignment checking in ARMv7-M:

- Support the unaligned access
- Generate a fault when an unaligned access occurs.

The policy varies with the type of access. An implementation can be configured to force alignment faults for all unaligned accesses (see below).

Writes to the PC are restricted according to the rules outlined in *Usage of 0b1111 as a register specifier* on page A4-39.

A3.2.1 Alignment Behavior

Address alignment affects data accesses and updates to the PC.

Alignment and data access

The following data accesses always generate an alignment fault:

- Non halfword-aligned LDREXH and STREXH
- Non word-aligned LDREX and STREX
- Non word-aligned LDRD, LDMIA, LDMDB, POP, and LDC
- Non word-aligned STRD, STMIA, STMDB, PUSH, and STC

The following data accesses support unaligned addressing, and only generate alignment faults when the ALIGN_TRP bit is set (see *The System Control Block (SCB)* on page B2-8):

- Non halfword-aligned LDR{S}H{T} and STRH{T}
- Non halfword-aligned TBH
- Non word-aligned LDR{T} and STR{T}

———— Note —————

LDREXD and STREXD are not supported in ARMv7-M

Accesses to Strongly Ordered and Device memory types must always be naturally aligned (see *Memory access restrictions* on page A3-24)

Alignment and updates to the PC

All instruction fetches must be halfword-aligned. Any exception return irregularities are captured as an INVSTATE or INVPC UsageFault by the exception return mechanism. See *Fault behavior* on page B1-14.

For exception entry and return:

- Exception entry using a vector with bit<0> clear causes an INVSTATE UsageFault
- A reserved EXC_RETURN value causes an INVPC Usagefault
- Loading an unaligned value from the stack into the PC on an exception return is UNPREDICTABLE

For all other cases where the PC is updated:

- If bit<0> of the value loaded to the PC using an ADD or MOV instruction is zero, the result is UNPREDICTABLE
- A BLX, BX, LDR to the PC, POP or LDM including the PC instruction will cause an INVSTATE UsageFault if bit<0> of the value loaded is zero
- Loading the PC with a value from a memory location whose address is not word aligned is UNPREDICTABLE

A3.3 Endian Support

The address space rules (*Address space* on page A3-2) require that for a word-aligned address A:

- The word at address A consists of the bytes at addresses A, A+1, A+2 and A+3
- The halfword at address A consists of the bytes at addresses A and A+1
- The halfword at address A+2 consists of the bytes at addresses A+2 and A+3
- The word at address A therefore consists of the halfwords at addresses A and A+2

However, this does not fully specify the mappings between words, halfwords and bytes. A memory system uses one of the following mapping schemes. This choice is known as the endianness of the memory system.

In a *little-endian* memory system:

- A byte or halfword at a word-aligned address is the least significant byte or halfword within the word at that address
- A byte at a halfword-aligned address is the least significant byte within the halfword at that address

In a *big-endian* memory system:

- A byte or halfword at a word-aligned address is the most significant byte or halfword within the word at that address
- A byte at a halfword-aligned address is the most significant byte within the halfword at that address

For a word-aligned address A, Table A3-1 and Table A3-2 show how the word at address A, the halfwords at address A and A+2, and the bytes at addresses A, A+1, A+2 and A+3 map onto each other for each endianness.

Table A3-1 Little-endian memory system

MSByte	MSByte -1	LSByte + 1	LSByte
Word at Address A			
Halfword at Address A+2		Halfword at Address A	
Byte at Address A+3	Byte at Address A+2	Byte at Address A+1	Byte at Address A

Table A3-2 Big-endian memory system

MSByte	MSByte -1	LSByte + 1	LSByte
Word at Address A			
Halfword at Address A		Halfword at Address A+2	
Byte at Address A	Byte at Address A+1	Byte at Address A+2	Byte at Address A +3

The big-endian and little-endian mapping schemes determines the order in which the bytes of a word or half-word are interpreted.

As an example, a load of a word (4 bytes) from address 0×1000 will result in an access of the bytes contained at memory locations 0×1000 , 0×1001 , 0×1002 and 0×1003 , regardless of the mapping scheme used. The mapping scheme determines the significance of those bytes.

A3.3.1 Control of the Endian Mapping in ARMv7-M

ARMv7-M supports a selectable endian model, that is configured to be big endian (BE-8) or little endian (LE-8) by a control input on system reset. The endian mapping has the following restrictions:

- The endian setting only applies to data accesses, instruction fetches are always little endian
- Loads and stores to the System Control Space (*System Control Space (SCS)* on page B2-7) are always little endian

Where big endian format instruction support is required, it can be implemented in the bus fabric. See *Endian support* on page AppxG-2 for more details.

Instruction alignment and byte ordering

Thumb-2 enforces 16-bit alignment on all instructions. This means that 32-bit instructions are treated as two halfwords, hw1 and hw2, with hw1 at the lower address.

In instruction encoding diagrams, hw1 is shown to the left of hw2. This results in the encoding diagrams reading more naturally. The byte order of a 32-bit Thumb instruction is shown in Figure A3-1.

Thumb 32-bit instruction order in memory

32-bit Thumb instruction, hw1				32-bit Thumb instruction, hw2			
15	8	7	0	15	8	7	0
Byte at Address A+1		Byte at Address A		Byte at Address A+3		Byte at Address A+2	

Figure A3-1 Instruction byte order in memory

A3.3.2 Element size and Endianness

The effect of the endianness mapping on data applies to the size of the element(s) being transferred in the load and store instructions. Table A3-3 shows the element size of each of the load and store instructions:.

Table A3-3 Load-store and element size association

Instruction class	Instructions	Element Size
Load/store byte	LDR{S}B{T}, STRB{T}, LDREXB, STREXB	byte
Load/store halfword	LDR{S}H{T}, STRH{T}, TBH, LDREXH, STREXH	halfword
Load/store word	LDR{T}, STR{T}, LDREX, STREX	word
Load/store two words	LDRD, STRD	word
Load/store multiple words	LDM{IA, DB}, STM{IA, DB}, PUSH, POP, LDC, STC	word

A3.3.3 Instructions to reverse bytes in a general-purpose register

When an application or device driver has to interface to memory-mapped peripheral registers or shared-memory structures that are not the same endianness as that of the internal data structures, or the endianness of the Operating System, an efficient way of being able to explicitly transform the endianness of the data is required.

Thumb-2 provides instructions for the following byte transformations (see the instruction definitions in Chapter A5 *Thumb Instructions* for details):

REV	Reverse word (four bytes) register, for transforming 32-bit representations.
REVSH	Reverse halfword and sign extend, for transforming signed 16-bit representations.
REV16	Reverse packed halfwords in a register for transforming unsigned 16-bit representations.

A3.4 Synchronization and semaphores

Exclusive access instructions support non-blocking shared-memory synchronization primitives that allow calculation to be performed on the semaphore between the read and write phases, and scale for multiple-processor system designs.

In ARMv7-M, the synchronization primitives provided are:

- Load-Exclusives:
 - LDREX, see *LDREX* on page A5-119
 - LDREXB, see *LDREXB* on page A5-121
 - LDREXH, see *LDREXH* on page A5-123
- Store-Exclusives:
 - STREX, see *STREX* on page A5-262
 - STREXB, see *STREXB* on page A5-264
 - STREXH, see *STREXH* on page A5-266
- Clear-Exclusive:
 - CLREX, see *CLREX* on page A5-65.

Note

This section describes the operation of a Load-Exclusive/Store-Exclusive pair of synchronization primitives using, as examples, the LDREX and STREX instructions. The same description applies to any other pair of synchronization primitives:

- LDREXB used with STREXB
- LDREXH used with STREXH.

Each Load-Exclusive instruction must be used only with the corresponding Store-Exclusive instruction.

STREXD and LDREXD are not supported in ARMv7-M.

The model for the use of a Load-Exclusive/Store-Exclusive instruction pair, accessing memory address *x* is:

- The Load-Exclusive instruction always successfully reads a value from memory address *x*
- The corresponding Store-Exclusive instruction succeeds in writing back to memory address *x* only if no other processor or process has performed a more recent Load-Exclusive of address *x*. The Store-Exclusive operation returns a status bit that indicates whether the memory write succeeded.

A Load-Exclusive instruction tags a small block of memory for exclusive access. The size of the tagged block is IMPLEMENTATION DEFINED, see *Size of the tagged memory block* on page A3-16. A Store-Exclusive instruction to the same address clears the tag.

These instructions operate with an address monitor that provides the state machine and associated system control for memory accesses. Two different monitor models exist, depending on whether the memory has the sharable or non-sharable memory attribute, see *Shared Normal memory* on page A3-22. Uniprocessor systems are only required to support the non-shared memory model. This means they can support synchronization primitives with the minimum amount of hardware overhead. Figure A3-2 on page A3-9 shows an example minimal system.

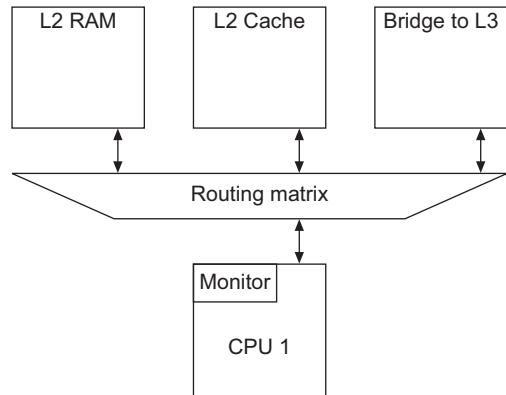

Figure A3-2 Example uniprocessor system, with non-shared monitor

Multiprocessor systems are required to implement an address monitor for each processor. Logically, a multiprocessor system must implement:

- A local monitor for each processor, that monitors Load-Exclusive and Store-Exclusive accesses to Non Shared memory by that processor. A local monitor can be unaware of all Load-Exclusive and Store-Exclusive accesses made by the other processors.
- A single global monitor, that monitors all Load-Exclusive and Store-Exclusive accesses to Shared memory, by all processors. The global monitor must maintain an exclusive access state machine for each processor.

However, it is IMPLEMENTATION DEFINED:

- where the monitors reside in the memory system hierarchy
- whether the monitors are implemented:
 - as a single entity for each processor, visible to all shared accesses
 - as a distributed entity.

Figure A3-3 shows a single entity approach in which the monitor supports state machines for both Shared and Non Shared memory accesses. Only the Shared memory case needs to snoop.

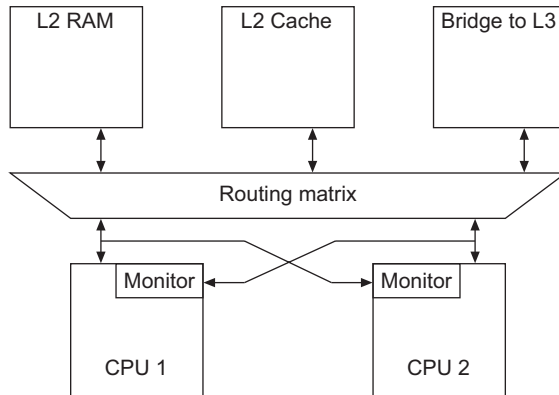

Figure A3-3 Global monitoring using write snoop monitor approach

Figure A3-4 shows a distributed model with a local monitors in each processor block, and global monitoring distributed across the targets of interest.

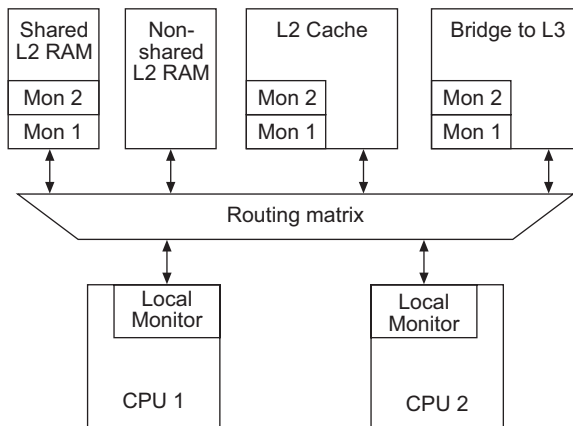

Figure A3-4 Global monitoring using monitor-at-target approach

A3.4.1 Exclusive access instructions and Non Shared memory regions

For memory regions that do not have the *Shared* attribute, the exclusive access instructions rely on a *local monitor* that tags any address from which the processor executes a Load-Exclusive. Any non-aborted attempt by the same processor to use a Store-Exclusive to modify any address is guaranteed to clear the tag.

Load-Exclusive performs a load from memory, and:

- the executing processor tags the fact that it has an outstanding tagged physical address to non-sharable memory
- the local monitor of the executing processor transitions to its Exclusive Access state.

Store-Exclusive performs a conditional store to memory:

- if the local monitor of the executing processor is in its Exclusive Access state:
 - the store takes place
 - a status value of 0 is returned to a register
 - the local monitor of the executing processor transitions to its Open Access state.
- if the local monitor of the executing processor is not in its Exclusive Access state:
 - no store takes place
 - a status value of 1 is returned to a register.

The Store-Exclusive instruction defines the register to which the status value is returned.

When a processor writes using any instruction other than a Store-Exclusive:

- if the write is to a physical address that is not covered by its local monitor the write does not affect the state of the local monitor
- if the write is to a physical address that is covered by its local monitor is IMPLEMENTATION DEFINED whether the write affects the state of the local monitor.

If the local monitor is in its Exclusive Access state and a processor performs a Store-Exclusive to any address in Non Shared memory other than the last one from which it has performed a Load-Exclusive, it is IMPLEMENTATION DEFINED whether the store succeeds. This mechanism:

- is used on a context switch, see *Context switch support* on page A3-16
- should be treated as a software programming error in all other cases.

———— **Note** —————

In non-shared memory, it is UNPREDICTABLE whether a store to a tagged physical address will cause a tag to be cleared if that store is by a processor other than the one that caused the physical address to be tagged.

The state machine for the local monitor is shown in Figure A3-5 on page A3-12.

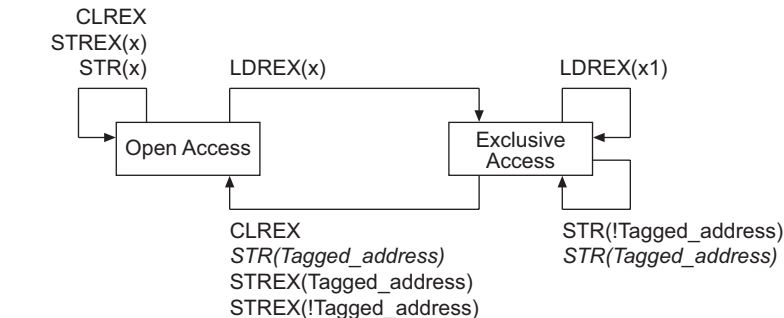

The operations in italics show possible alternative IMPLEMENTATION DEFINED options.

Figure A3-5 Local monitor state machine diagram

Note

The IMPLEMENTATION DEFINED options for the local monitor are consistent with the local monitor being constructed so that it does not hold any physical address, but instead treats any access as matching the address of the previous LDREX.

Table A3-4 shows the effect of the Load-Exclusive and Store-Exclusive instructions shown in Figure A3-5.

Table A3-4 Effect of Exclusive instructions on local monitor

Initial state	Operation ^a	Effect	Final state
Open access	CLREX	No effect	Open access
Open access	STREX(x)	Does not update memory, returns status 1	Open access
Open access	LDREX(x)	Loads value from memory, tags address x	Exclusive access
Exclusive access	CLREX	Clears tagged address	Open access
Exclusive access	STREX(t)	Updates memory, returns status 0	Open access
Exclusive access	STREX(!t)	Updates memory, returns status 0	Open access
Exclusive access	LDREX(x1)	Loads value from memory, changes tag to address to x1	Exclusive access

a. STREX and LDREX are used as examples of the exclusive access instructions. t is the tagged address, bits[31:a] of the address of the last Load-Exclusive instruction, see *Size of the tagged memory block* on page A3-16.

Figure A3-5 shows the behavior of the local address monitor associated with the processor issuing the LDREX, STREX and STR instructions. It is UNPREDICTABLE whether the transition from Exclusive Access to Open Access occurs when the STR or STREX is from a different processor. A local monitor implementation can be unaware of Load-Exclusive and Store-Exclusive operations from other processors.

A3.4.2 Exclusive access instructions and shared memory regions

For memory regions that have the *Shared* attribute, exclusive access instructions rely on:

- A *local monitor* for each processor in the system, that tags any address from which the processor executes a Load-Exclusive. The local monitor operates as described in *Exclusive access instructions and Non Shared memory regions* on page A3-11, and can ignore exclusive accesses from other processors in the system.
- A single *global monitor* that tags a physical address as exclusive access for a particular processor. This tag is used later to determine whether an Store-Exclusive to that address can occur. Any non-aborted attempt to modify the tagged address by any processor is guaranteed to clear the tag. For each processor in the system, the global monitor:
 - holds a single tagged address
 - maintains a state machine.

The global monitor can either:

- reside in a processor block, as illustrated in Figure A3-3 on page A3-10
- exist as a secondary monitor at the memory interfaces, as shown in Figure A3-4 on page A3-10.

An implementation can combine the functionality of the global and local monitors into a single unit.

Operation of the global monitor

Load-Exclusive from *shared* memory performs a load from memory, and causes the physical address of the access to be tagged as exclusive access for the requesting processor. This access also causes the exclusive access tag to be removed from any other physical address that has been tagged by the requesting processor. The global monitor only supports a single outstanding exclusive access to sharable memory per processor.

Store-Exclusive performs a conditional store to memory:

- The store is guaranteed to succeed only if the physical address accessed is tagged as exclusive access for the requesting processor and both the local monitor and the global monitor state machine for the requesting processor are in the Exclusive Access state. In this case:
 - a status value of 0 is returned to a register to acknowledge the successful store
 - the final state of the global for the requesting processor is implementation defined
 - the global monitor for any other processor that has tagged the address accessed transitions to Open Access.
- If no address is tagged as exclusive access for the requesting processor, the store does not succeed:
 - a status value of 1 is returned to a register to indicate that the store failed
 - the global monitor is not affected and remains Open Access for the requesting processor.
- If a different physical address is tagged as exclusive access for the requesting processor, it is IMPLEMENTATION DEFINED whether the store succeeds or not:
 - if the store succeeds a status value of 0 is returned to a register, otherwise a value of 1 is returned

- if the global monitor for the processor was in the Open Access state before the Store-Exclusive it remains in the Open Access state
- if the global monitor for the processor was in the Exclusive Access state before the Store-Exclusive it is IMPLEMENTATION DEFINED whether the global monitor transitions to the Open Access state.

The Store-Exclusive instruction defines the register to which the status value is returned.

In a shared memory system, the global monitor must implement a separate state machine for each processor in the system. In this context, the term processor includes any independent DMA agent. The state machine for Shared memory accesses by processor(n) can respond to all the Shared memory transactions visible to it:

- transactions generated by the associated processor (n)
- transactions generated by the other processors in the shared memory system (!n).

The state machine behavior is illustrated in Figure A3-6.

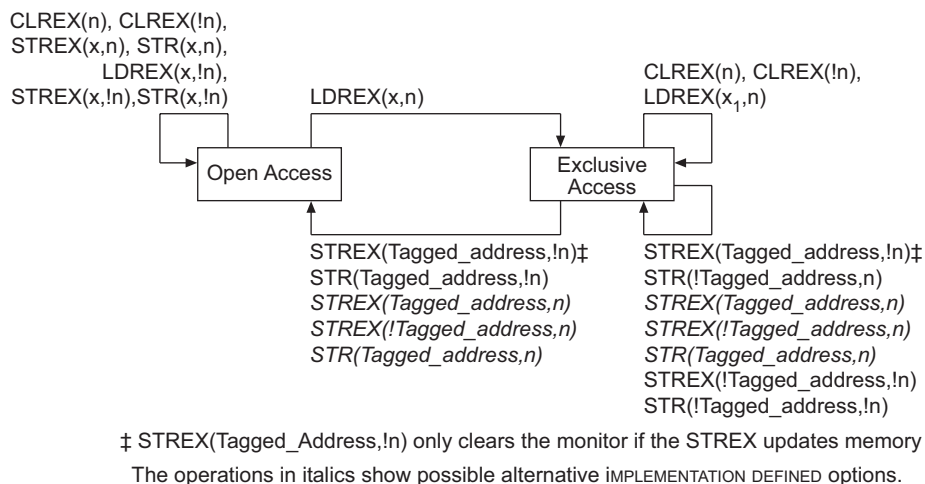

Figure A3-6 Global monitor state machine diagram for processor(n) in a multiprocessor system

Note

- Whether a Store-Exclusive successfully updates memory or not depends on whether the address accessed matches the tagged shared memory address for the processor issuing the Store-Exclusive instruction. For this reason, Figure A3-6 and Table A3-5 on page A3-15 only show how the (!n) entries cause state transitions of the state machine for processor n.
- An Load-Exclusive can only update the tagged shared memory address for the processor issuing the Load-Exclusive instruction.
- CLREX instructions do not affect the global monitor.

Table A3-5 shows the effect of the Load-Exclusive and Store-Exclusive instructions shown in Figure A3-6 on page A3-14.

Table A3-5 Effect of Exclusive instructions on global monitor for processor n

Initial state ^a	Operation ^b	Effect	Final state ^a
Open	CLREX(n), CLREX(!n)	None	Open
Open	STREX(x,n)	Does not update memory, returns status 1	Open
Open	LDREX(x,!n)	Loads value from memory, no effect on tag address for processor n	Open
Open	STREX(x,!n)	Depends on state machine and tag address for processor issuing STREX	Open
Open	LDREX(x,n)	Loads value from memory, tags address x	Exclusive
Exclusive	LDREX(x1,n)	Loads value from memory, tags address x1	Exclusive
Exclusive	CLREX(n), CLREX(!n)	None	Exclusive
Exclusive	STREX(t,!n)	Updates memory, returns status 0 ^c	Open
		Does not update memory, returns status 1 ^c	Exclusive
Exclusive	STREX(t,n)	Updates memory, returns status 0 ^d	Open
			Exclusive
Exclusive	STREX(!t,n)	Updates memory, returns status 0 ^e	Open
			Exclusive
			Open
Exclusive	STREX(!t,!n)	Depends on state machine and tag address for processor issuing STREX	Open
			Exclusive

- Open = Open access, Exclusive = Exclusive access.
- STREX and LDREX are used as examples of the exclusive access instructions. t is the tagged address for processor n, bits[31:a] of the address of the last LDREX instruction issued by processor n, see *Size of the tagged memory block* on page A3-16.
- The result of the STREX(t,!n) operation depends on the state machine and tagged address for the processor issuing the STREX instruction. This table shows how each possible outcome affects the state machine for processor n.
- After a successful STREX to the tagged address, the state of the state machine is IMPLEMENTATION DEFINED. However, this state has no effect on the subsequent operation of the global monitor.

- e. Effect is IMPLEMENTATION DEFINED. The table shows all permitted implementations.

A3.4.3 Size of the tagged memory block

As shown in Figure A3-5 on page A3-12 and Figure A3-6 on page A3-14, when a LDREX instruction is executed, the resulting tag address ignores the least significant bits of the memory address:

```
Tagged_address == Memory_address[31:a]
```

The value of *a* in this assignment is IMPLEMENTATION DEFINED, between a minimum value of 2 and a maximum value of 7. For example, in an implementation where *a* = 4, a successful LDREX of address 0x000341B4 gives a tag value of bits [31:4] of the address, giving 0x000341B. This means that the four words of memory from 0x000341B0 to 0x000341BF are tagged for exclusive access. Subsequently, a valid STREX to any address in this block will remove the tag.

Therefore, the size of the tagged memory block is IMPLEMENTATION DEFINED between:

- one word, in an implementation with *a* = 2
- 32 words, in an implementation with *a* = 7.

A3.4.4 Context switch support

It is necessary to ensure that the local monitor is in the Open Access state after a context switch. In ARMv7-M, the local monitor is changed to Open Access automatically as part of an exception entry or exit sequence. The local monitor can also be forced to the Open Access state by a CLREX instruction.

————— Note —————

Context switching is not an application level operation. However, this information is included here to complete the description of the exclusive operations.

The STREX or CLREX instruction following a context switch might cause a subsequent Store-Exclusive to fail, requiring a load ... store sequence to be replayed. To minimize the possibility of this happening, ARM Limited recommends that the Store-Exclusive instruction is kept as close as possible to the associated Load-Exclusive instruction, see *Load-Exclusive and Store-Exclusive usage restrictions*.

A3.4.5 Load-Exclusive and Store-Exclusive usage restrictions

The Load-Exclusive and Store-Exclusive instructions are designed to work together, as a pair, for example a LDREX/STREX pair or a LDREXB/STREXB pair. As mentioned in *Context switch support*, ARM Limited recommends that the Store-Exclusive instruction always follows within a few instructions of its associated Load-Exclusive instructions. In order to support different implementations of these functions, software must follow the notes and restrictions given here.

These notes describe use of a LDREX/STREX pair, but apply equally to any other Load-Exclusive/Store-Exclusive pair:

1. The exclusives are designed to support a single outstanding exclusive access for each processor thread that is executed. The architecture makes use of this by not mandating an address or size check as part of the IsExclusiveLocal() function. If the target address of an STREX is different from the preceding LDREX within the same execution thread, behavior can be UNPREDICTABLE. As a result, an LDREX/STREX pair can only be relied upon to eventually succeed if they are executed with the same address. Where a context switch or exception might result in a change of execution thread, a CLREX instruction or a dummy STREX instruction must be executed to avoid unwanted effects, as described in *Context switch support* on page A3-16. Using an STREX in this way is the only occasion where software can program an STREX with a different address from the previously executed LDREX.
2. An explicit store to memory can cause the clearing of exclusive monitors associated with other processors, therefore, performing a store between the LDREX and the STREX can result in a livelock situation. As a result, code must avoid placing an explicit store between an LDREX and an STREX within a single code sequence.
3. Two STREX instructions executed without an intervening LDREX will also result in the second STREX returning a status value of 1. As a result:
 - each STREX must have a preceding LDREX associated with it within a given thread of execution
 - it is not necessary for each LDREX to have a subsequent STREX.
4. Implementations can cause apparently spurious clearing of the exclusive monitor between the LDREX and the STREX, as a result of, for example, cache evictions. Code designed to run on such implementations should avoid having any explicit memory transactions or cache maintenance operations between the LDREX and STREX instructions.
5. Implementations can benefit from keeping the LDREX and STREX operations close together in a single code sequence. This minimizes the likelihood of the exclusive monitor state being cleared between the LDREX instruction and the STREX instruction. Therefore, ARM Limited strongly recommends a limit of 128 bytes between LDREX and STREX instructions in a single code sequence, for best performance.
6. Implementations that implement coherent protocols, or have only a single master, might combine the local and global monitors for a given processor. The IMPLEMENTATION DEFINED and UNPREDICTABLE parts of the definitions in are designed to cover this behavior.
7. The architecture sets an upper limit of 128 bytes on the regions that can be marked as exclusive. Therefore, for performance reasons, ARM Limited recommends that software separates objects that will be accessed by exclusive accesses by at least 128 bytes. This is a performance guideline rather than a functional requirement.
8. LDREX and STREX operations must be performed only on memory with the Normal memory attribute.

A3.4.6 Synchronization primitives and the memory order model

The synchronization primitives follow the memory ordering model of the memory type accessed by the instructions. For this reason:

- Portable code for claiming a spinlock must include a DMB instruction between claiming the spinlock and making any access that makes use of the spinlock.
- Portable code for releasing a spinlock must include a DMB instruction before writing to clear the spinlock.

This requirement applies to code using the Load-Exclusive/Store-Exclusive instruction pairs, for example LDREX/STREX.

A3.5 Memory types

ARMv7 defines a set of memory attributes with the characteristics required to support all memory and devices in the system memory map. The ordering of accesses for regions of memory is also defined by the memory attributes.

There are three mutually exclusive main memory type attributes to describe the memory regions:

- Normal
- Device
- Strongly Ordered.

Memory used for program execution and data storage generally complies with Normal memory. Examples of Normal memory technology are:

- preprogrammed Flash (updating Flash memory can impose stricter ordering rules)
- ROM
- SRAM
- SDRAM and DDR memory

System peripherals (I/O) generally conform to different access rules; defined as Strongly Ordered or Device memory. Examples of I/O accesses are:

- FIFOs where consecutive accesses add (write) or remove (read) queued values
- interrupt controller registers where an access can be used as an interrupt acknowledge changing the state of the controller itself
- memory controller configuration registers that are used to set up the timing (and correctness) of areas of normal memory
- memory-mapped peripherals where the accessing of memory locations causes side effects within the system.

In addition, the Shared attribute indicates whether Normal or Device memory is private to a single processor, or accessible from multiple processors or other bus master resources, for example, an intelligent peripheral with DMA capability.

Strongly Ordered memory is required where it is necessary to ensure strict ordering of the access with respect to what occurred in program order before the access and after it. Strongly Ordered memory always assumes the resource is shared.

Table A3-6 provides a summary of the memory attributes.

Table A3-6 Summary of memory attributes

Memory type attribute	Shared attribute	Other attribute	Description
Strongly ordered			All memory accesses to Strongly Ordered memory occur in program order. All Strongly Ordered accesses are assumed to be Shared.
Device	Shared		Designed to handle memory mapped peripherals that are shared by several processors.
	Non-shared		Designed to handle memory mapped peripherals that are used only by a single processor.
Normal	Shared	Non-cacheable/Write-Through cacheable/Write-Back cacheable	Designed to handle normal memory which is shared between several processors.
	Non-shared	Non-cacheable/Write-Through cacheable/Write-Back cacheable	Designed to handle normal memory which is used only by a single processor.

A3.5.1 Atomicity

The terms *Atomic* and *Atomicity* are used within computer science to describe a number of properties for memory accesses. Within the ARM architecture, the following definitions are used:

Single-copy atomicity

The property of *Single-copy atomicity* is exhibited for read and write operations if the following conditions are met:

1. After every two write operations to an operand, either the value of the first write operation or the value of the second write operation remains in the operand. Thus, it is impossible for part of the value of the first write operation and part of the second write operation to remain in the operand.
2. When a read operation and a write operation occur to the same operand, the value obtained by the read operation is either the value of the operand before the write operation or the value of the operand after the write operation. It is never the case that the value of the read operation is partly the value of the operand before the write operation and partly the value of the operand after the write operation.

The only ARMv7-M explicit accesses made by the ARM processor which exhibit single-copy atomicity are:

- All byte transactions
- All halfword transactions to 16-bit aligned locations
- All word transactions to 32-bit aligned locations

LDM, LDC, LDRD, STM, STC, STRD, PUSH and POP operations are seen to be a sequence of 32-bit transactions aligned to 32 bits. Each of these 32-bit transactions are guaranteed to exhibit single-copy atomicity. Sub-sequences of two or more 32-bit transactions from the sequence also do not exhibit single-copy atomicity.

Where a transaction does not exhibit single-copy atomicity, it is seen as a sequence of transactions of bytes which do exhibit single-copy atomicity.

For implicit accesses:

- Cache linefills/evictions are seen to be a sequence of 32-bit transactions aligned to 32 bits. Each of these 32-bit transactions exhibits single-copy atomicity. Sub-sequences of two or more 32-bit transactions from the sequence also do not exhibit single-copy atomicity
- Instruction fetches exhibit single-copy atomicity for the individual instructions being fetched; it must be noted that 32-bit thumb instructions are comprised of 2 16-bit quantities.

Multi-copy atomicity

In a multiprocessing system, writes to a memory location exhibit *Multi-copy atomicity* if:

1. All writes to the same location are *serialised* that is they are observed in the same order to all copies of the location.
2. The value of a write is not returned by a read until all copies of the location have seen that write

No writes to Normal memory exhibit Multi-copy atomicity

All writes to Device and Strongly-Ordered memory which exhibit Single-copy atomicity also exhibit Multi-copy atomicity.

All write transactions to the same location are serialised. Write transactions to Normal memory can be repeated up to the point that another write to the same address is observed.

Serialisation of writes does not prohibit the merging of writes for Normal memory.

A3.5.2 Normal memory attribute

Normal memory is idempotent, exhibiting the following properties:

- read transactions can be repeated with no side effects
- repeated read transactions return the last value written to the resource being read
- read transactions can prefetch additional memory locations with no side effects.

- write transactions can be repeated with no side effects, provided that the location is unchanged between the repeated writes
- unaligned accesses can be supported
- transactions can be merged prior to accessing the target memory system

Normal memory can be read/write or read-only. The Normal memory attribute can be further defined as being Shared or Non-Shared, and describes most memory used in a system.

Accesses to Normal Memory conform to the weakly-ordered model of memory ordering. A description of the weakly-ordered model can be found in standard texts describing memory ordering issues. A recommended text is chapter 2 of *Memory Consistency Models for Shared Memory-Multiprocessors*, Kourosh Gharachorloo, Stanford University Technical Report CSL-TR-95-685.

All explicit accesses must correspond to the ordering requirements of accesses described in *Memory access order* on page A3-27.

Instructions which conform to the 32-bit sequence of transactions classification as defined in *Atomicity* on page A3-20 can be abandoned if a MemManage or BusFault exception occurs during the sequence of transactions. The instruction will be restarted on return from the exception, and one or more of the memory locations can be accessed multiple times. For Normal memory, this can result in repeated write transactions to a location which has been changed between the repeated writes.

Non-shared Normal memory

The Non-Shared Normal memory attribute is designed to describe normal memory that can be accessed only by a single processor.

A region of memory marked as Non-Shared Normal does not have any requirement to make the effect of a cache transparent. For regions of memory marked as Non-shared Non-cacheable, a Data Synchronization Barrier (DSB) instruction must be used in situations where previous accesses must be made visible to other observers. See *Memory barriers* on page A3-30 for more details.

Shared Normal memory

The Shared Normal memory attribute is designed to describe normal memory that can be accessed by multiple processors or other system masters.

A region of memory marked as Shared Normal is one in which the effect of interposing a cache (or caches) on the memory system is entirely transparent to data accesses. Explicit software management is still required to ensure coherency of instruction caches. Implementations can use a variety of mechanisms to support this, from very simply not caching accesses in shared regions to more complex hardware schemes for cache coherency for those regions.

Cacheable write-through, cacheable write-back and non-cacheable memory

In addition to marking a region of Normal memory as being Shared or Non-Shared, regions can also be marked as being one of:

- cacheable write-through

- cacheable write-back
- non-cacheable.

This marking is independent of the marking of a region of memory as being Shared or Non-Shared. It indicates the required handling of the data region for reasons other than those to handle the requirements of shared data. As a result, it is acceptable for a region of memory that is marked as being cacheable and shared not to be held in the cache in an implementation which handles shared regions as not caching the data.

A3.5.3 Device memory attribute

The Device memory attribute is defined for memory locations where an access to the location can cause side effects, or where the value returned for a load can vary depending on the number of loads performed. Memory mapped peripherals and I/O locations are typical examples of areas of memory that should be marked as being Device.

Explicit accesses from the processor to regions of memory marked as Device occur at the size and order defined by the instruction. The number of accesses that occur to such locations is the number that is specified by the program. Implementations must not repeat accesses to such locations when there is only one access in the program, that is, the accesses are not restartable. An example where an implementation might want to repeat an access is before and after an interrupt, in order to allow the interrupt to cause a slow access to be abandoned. Such implementation optimizations must not be performed for regions of memory marked as Device.

In addition, address locations marked as Device are non-cacheable. While writes to device memory can be buffered, writes shall only be merged where the correct number of accesses, order, and their size is maintained. Multiple accesses to the same address cannot change the number or order of accesses to that address. Coalescing of accesses is not permitted in this case.

Accesses to Device memory can exhibit side effects. Device memory operations that have side effects that apply to Normal memory locations require Memory Barriers to ensure correct execution. An example is the programming of the configuration registers of a memory controller with respect to the memory accesses it controls.

All explicit accesses to memory marked as Device must correspond to the ordering requirements of accesses described in *Memory access order* on page A3-27.

Shared attribute

The Shared attribute is defined by memory region and can be referred to as:

- memory marked as Shared Device
- memory marked as Non-Shared Device

Memory marked as Non-Shared Device is defined as only accessible by a single processor. An example of a system supporting Shared and Non-shared Device memory is an implementation that supports a local bus for its private peripherals, whereas system peripherals are situated on the main (Shared) system bus. Such a system can have more predictable access times for local peripherals such as watchdog timers or interrupt controllers.

A3.5.4 Strongly Ordered memory attribute

Accesses to memory marked as Strongly Ordered have a strong memory-ordering model for all explicit memory accesses from that processor. An access to memory marked as Strongly Ordered is required to act as if a DMB memory barrier instruction were inserted before and after the access from that processor. See *Data Memory Barrier (DMB)* on page A3-31 for DMB details.

Explicit accesses from the processor to memory marked as Strongly Ordered occur at their program size, and the number of accesses that occur to such locations is the number that are specified by the program. Implementations must not repeat accesses to such locations when there is only one access in the program, that is, the accesses are not restartable.

Address locations marked as Strongly Ordered are not held in a cache, and are always treated as Shared memory locations.

All explicit accesses to memory marked as Strongly Ordered must correspond to the ordering requirements of accesses described in *Memory access order* on page A3-27.

A3.5.5 Memory access restrictions

The following restrictions apply to memory accesses:

- For any access X, the bytes accessed by X must all have the same memory type attribute, otherwise, the behavior of the access is UNPREDICTABLE. That is, unaligned accesses that span a boundary between different memory types are UNPREDICTABLE.
- For any two memory accesses X and Y, such that X and Y are generated by the same instruction, X and Y must all have the same memory type attribute, otherwise, the results are UNPREDICTABLE. For example, an LDC, LDM, LDRD, STC, STM, or STRD that spans a boundary between Normal and Device memory is UNPREDICTABLE.
- Instructions that generate unaligned memory accesses to Device or Strongly Ordered memory are UNPREDICTABLE.
- For instructions that generate accesses to Device or Strongly Ordered memory, implementations do not change the sequence of accesses specified by the pseudo-code of the instruction. This includes not changing how many accesses there are, nor their time order, nor the data sizes and other properties of each individual access. Furthermore, processor core implementations expect any attached memory system to be able to identify accesses by memory type, and to obey similar restrictions with regard to the number, time order, data sizes and other properties of the accesses.

Exceptions to this rule are:

- An implementation of a processor core can break this rule, provided that the information it does supply to the memory system enables the original number, time order, and other details of the accesses to be reconstructed. In addition, the implementation must place a requirement on attached memory systems to do this reconstruction when the accesses are to Device or Strongly Ordered memory.

For example, the word loads generated by an LDM can be paired into 64-bit accesses by an implementation with a 64-bit bus. This is because the instruction semantics ensure that the 64-bit access is always a word load from the lower address followed by a word load from the higher address, provided a requirement is placed on memory systems to unpack the two word loads where the access is to Device or Strongly Ordered memory.

- Any implementation technique that produces results that cannot be observed to be different from those described above is legitimate.
- Multi-access instructions that load or store the PC must only access normal memory. If they access Device or Strongly Ordered memory the results are UNPREDICTABLE.
- Instruction fetches must only access normal memory. If they access Device or Strongly Ordered memory, the results are UNPREDICTABLE. By example, instruction fetches must not be performed to areas of memory containing read-sensitive devices, because there is no ordering requirement between instruction fetches and explicit accesses.

Implementations can prefetch by an IMPLEMENTATION DEFINED amount down a sequential path from the instruction currently being executed. To ensure correctness, read-sensitive locations must be marked as non-executable (see *User/privileged access and Read/Write access control for Instruction Accesses* on page A3-26).

A3.6 Access rights

Access rights split into two classes:

- Rights for data accesses
- Rights for instruction prefetching

Furthermore, the access right can be restricted to privileged execution only.

A3.6.1 User/privileged access and Read/Write access control for Data Accesses

The memory attributes are allowed to define for explicit reads and for explicit writes that a region of memory is:

- Not accessible to any accesses
- Accessible only to Privileged accesses
- Accessible to Privileged and Non-Privileged accesses

Not all combinations of memory attributes for reads and writes are supported by all systems which define the memory attributes.

If an attempt is made to read or write non-accessible data, a data access error will occur. Privileged accesses are accesses made as a result of a load or store operation (other than LDRT, STRT, LDRBT, STRBT, LDRHT, STRHT, LDRSHT, LDRSBT) during privileged execution.

Unprivileged accesses are accesses made as a result of a load or store operation when the processor is executing unprivileged code, or any made as a result of the following instructions:

LDRT, STRT, LDRBT, STRBT, LDRHT, STRHT, LDRSHT, LDRSBT

A3.6.2 User/privileged access and Read/Write access control for Instruction Accesses

The memory attributes can define that a region of memory is:

- Not accessible for execution
Prefetching must not occur from locations marked as non-executable
- Accessible for execution by Privileged processes only
- Accessible for execution by Privileged and Non-Privileged processes

The mechanism by which this is described is that the region is described as accessible for reads by a privileged read access (or by privileged and non-privileged read access) and is suitable for execution. As a result, there is some linkage between the memory attributes which define the accessibility to explicit memory accesses, and those which define that a region can be executed.

If execution is attempted to any memory locations for which the attributes are not permitted, an instruction execution error will occur.

A3.7 Memory access order

The memory types defined in *Memory types* on page A3-19 have associated memory ordering rules to provide system compatibility for software between different implementations. The rules are defined to accommodate the increasing difficulty of ensuring linkage between the completion of memory accesses and the execution of instructions within a complex high-performance system, while also allowing simple systems and implementations to meet the criteria with predictable behaviour.

The memory order model determines:

- when side effects are guaranteed to be visible
- the requirements for memory consistency

Shared memory indicating whether a region of memory is shared between multiple processors (and therefore requires an appearance of cache transparency in an ordering model) is supported. Implementations remain free to choose the mechanisms to implement this functionality.

Additional attributes and behaviors relate to the memory system architecture. These features are defined in other areas of this manual (see *Access rights* on page A3-26, Chapter C1 *Debug* and Chapter B1 *System Level Programmer's Model* on access permissions, the system memory map and the Protected Memory System Architecture respectively).

A3.7.1 Read and write definitions

Memory accesses can be either reads or writes.

Reads

Reads are defined as memory operations that have the semantics of a load. For ARMv7-M and Thumb-2 these are:

- LDR{S}B{T}, LDR{S}H{T}, LDR{T}
- LDMIA, LDMDB, LDRD, POP, LDC
- LDREX{B, H}, STREX{B, H}
- TBB, TBH

Writes

Writes are defined as operations that have the semantics of a store. For ARMv7-M and Thumb-2 these are:

- STRB{T}, STRH{T}, STR{T}
- STMIA, STMDB, STRD, PUSH, STC, STREX{B, H}

Memory synchronization primitives

Synchronization primitives are required to ensure correct operation of system semaphores within the memory order model. The memory synchronization primitive instructions are defined as those instructions that are used to ensure memory synchronization:

LDREX{B,H}, STREX{B,H}

These instructions are supported to shared and non-shared memory. Non-shared memory can be used when the processes to be synchronized are running on the same processor. When the processes to be synchronized are running on different processors, shared memory must be used.

A3.7.2 Observability and completion

The concept of observability applies to all memory, however, the concept of global observability only applies to shared memory. Normal, Device and Strongly Ordered memory are defined in *Memory types* on page A3-19.

For all memory:

- A write to a location in memory is said to be observed by a memory system agent (the observer) when a subsequent read of the location by the observer returns the value written by the write.
- A write to a location in memory is said to be globally observed when a subsequent read of the location by any memory system agent returns the value written by the write.
- A read to a location in memory is said to be observed by a memory system agent (the observer) when a subsequent write of the location by the observer has no effect on the value returned by the read.
- A read to a location in memory is said to be globally observed when a subsequent write of the location by any memory system agent has no effect on the value returned by the read.

Additionally, for Strongly Ordered memory:

- A read or write to a memory mapped location in a peripheral which exhibits side-effects is said to be observed, and globally observed, only when the read or write meets the general conditions listed, can begin to affect the state of the memory-mapped peripheral, and can trigger any side effects that affect other peripheral devices, cores and/or memory.

For all memory, a read or write is defined to be complete when it is globally observed:

- A branch predictor maintenance operation is defined to be complete when the effects of operation are globally observed.

To determine when any side effects have completed, it is necessary to poll a location associated with the device, for example, a status register.

Side effect completion in Strongly Ordered and Device memory

For all memory-mapped peripherals, where the side-effects of a peripheral are required to be visible to the entire system, the peripheral must provide an IMPLEMENTATION DEFINED location which can be read to determine when all side effects are complete.

This is a key element of the architected memory order model.

A3.7.3 Ordering requirements for memory accesses

ARMv7-M defines access restrictions in the memory ordering allowed, depending on the memory attributes of the accesses involved. Table A3-7 shows the memory ordering between two explicit accesses A1 and A2, where A1 (as listed in the first column) occurs before A2 (as listed in the first row) in program order.

The symbols used in Table A3-76-3 are as follows:

- < Accesses must be globally observed in program order, that is, A1 must be globally observed strictly before A2.
- (blank)** Accesses can be globally observed in any order, provided that the requirements of uniprocessor semantics, for example respecting dependencies between instructions within a single processor, are maintained.

Table A3-7 Memory order restrictions

A1	A2	Device Access		Strongly Ordered Access
	Normal Access	(Non-Shared)	(Shared)	
Normal Access				<
Device Access (Non-Shared)		<		<
Device Access (Shared)			<	<
Strongly Ordered Access	<	<	<	<

There are no ordering requirements for implicit accesses to any type of memory.

A3.7.4 Program order for instruction execution

Program order of instruction execution is the order of the instructions in the control flow trace. Explicit memory accesses in an execution can be either:

Strictly Ordered Denoted by <. Must occur strictly in order.

Ordered Denoted by <=. Must occur either in order, or simultaneously.

Multiple load and store instructions, such as LDM{IA | | DB}, LDRD, POP, STM{IA | | DB}, PUSH and STRD, generate multiple word accesses, each of which is a separate access for the purpose of determining ordering.

The rules for determining program order for two accesses A1 and A2 are:

If A1 and A2 are generated by two different instructions:

- A1 < A2 if the instruction that generates A1 occurs before the instruction that generates A2 in program order
- A2 < A1 if the instruction that generates A2 occurs before the instruction that generates A1 in program order.

If A1 and A2 are generated by the same instruction:

- If A1 and A2 are the load and store generated by a SWP or SWPB instruction:
 - A1 < A2 if A1 is the load and A2 is the store
 - A2 < A1 if A2 is the load and A1 is the store.
- If A1 and A2 are two word loads generated by an LDC, LDRD, or LDM instruction, or two word stores generated by an STC, STRD, or STM instruction, excluding LDM or STM instructions whose register list includes the PC:
 - A1 <= A2 if the address of A1 is less than the address of A2
 - A2 <= A1 if the address of A2 is less than the address of A1.
- If A1 and A2 are two word loads generated by an LDM instruction whose register list includes the PC or two word stores generated by an STM instruction whose register list includes the PC, the program order of the memory operations is not defined.
- If A1 and A2 are two word loads generated by an LDRD instruction or two word stores generated by an STRD instruction whose register list includes the PC, the instruction is UNPREDICTABLE.

A3.7.5 Memory barriers

Memory barrier is the general term applied to an instruction, or sequence of instructions, used to force synchronization events by a processor with respect to retiring load/store instructions in a processor core. A memory barrier is used to guarantee completion of preceding load/store instructions to the programmer's model, flushing of any prefetched instructions prior to the event, or both. ARMv7-M includes three explicit barrier instructions to support the memory order model. The instructions can execute from privileged or unprivileged code.

- Data Memory Barrier (DMB) as described in *Data Memory Barrier (DMB)* on page A3-31
- Data Synchronization Barrier (DSB) as described in *Data Synchronization Barrier (DSB)* on page A3-31
- Instruction Synchronization Barrier (ISB) as described in *Instruction Synchronization Barrier (ISB)* on page A3-31

Explicit memory barriers affect reads and writes to the memory system generated by load and store instructions being executed in the CPU. Reads and writes generated by DMA transactions and instruction fetches are not explicit accesses.

A3.7.6 Data Memory Barrier (DMB)

DMB acts as a data memory barrier, exhibiting the following behavior:

- All explicit memory accesses by instructions occurring in program order before this instruction are globally observed before any explicit memory accesses due to instructions occurring in program order after this instruction are observed.
- The DMB instruction has no effect on the ordering of other instructions executing on the processor.

As such, DMB ensures the apparent order of the explicit memory operations before and after the instruction, without ensuring their completion. For details on the DMB instruction, see Chapter A5 *Thumb Instructions*.

A3.7.7 Data Synchronization Barrier (DSB)

The DSB instruction operation acts as a special kind of Data Memory Barrier. The DSB operation completes when all explicit memory accesses before this instruction complete.

In addition, no instruction subsequent to the DSB can execute until the DSB completes. For details on the DSB instruction, see Chapter A5 *Thumb Instructions*.

A3.7.8 Instruction Synchronization Barrier (ISB)

The ISB instruction flushes the pipeline in the processor, so that all instructions following the pipeline flush are fetched from memory after the instruction has been completed. It ensures that the effects of context altering operations, such as branch predictor maintenance operations, as well as all changes to the special-purpose registers where applicable (see *The special-purpose control register* on page B1-9) executed before the ISB instruction are visible to the instructions fetched after the ISB.

In addition, the ISB instruction ensures that any branches which appear in program order after the ISB are always written into the branch prediction logic with the context that is visible after the ISB. This is required to ensure correct execution of the instruction stream.

Any context altering operations appearing in program order after the ISB only take effect after the ISB has been executed. This is due to the behavior of the context altering instructions.

ARM implementations are free to choose how far ahead of the current point of execution they prefetch instructions; either a fixed or a dynamically varying number of instructions. As well as being free to choose how many instructions to prefetch, an ARM implementation can choose which possible future execution path to prefetch along. For example, after a branch instruction, it can choose to prefetch either the instruction following the branch or the instruction at the branch target. This is known as branch prediction.

A potential problem with all forms of instruction prefetching is that the instruction in memory can be changed after it was prefetched but before it is executed. If this happens, the modification to the instruction in memory does not normally prevent the already prefetched copy of the instruction from executing to completion. The ISB and memory barrier instructions (DMB or DSB as appropriate) are used to force execution ordering where necessary.

For details on the ISB instruction, see Chapter A5 *Thumb Instructions*.

A3.8 Caches and memory hierarchy

Support for caches in ARMv7-M is limited to memory attributes. These can be exported on a supporting bus protocol such as AMBA (AHB or AXI protocols) to support system caches.

In situations where a breakdown in coherency can occur, software must manage the caches using cache maintenance operations which are memory mapped and IMPLEMENTATION DEFINED.

A3.8.1 Introduction to caches

A cache is a block of high-speed memory locations containing both address information (commonly known as a TAG) and the associated data. The purpose is to increase the average speed of a memory access. Caches operate on two principles of locality:

Spatial locality an access to one location is likely to be followed by accesses from adjacent locations, for example, sequential instruction execution or usage of a data structure

Temporal locality an access to an area of memory is likely to be repeated within a short time period, for example, execution of a code loop

To minimise the quantity of control information stored, the spatial locality property is used to group several locations together under the same TAG. This logical block is commonly known as a cache line. When data is loaded into a cache, access times for subsequent loads and stores are reduced, resulting in overall performance benefits. An access to information already in a cache is known as a cache hit, and other accesses are called cache misses.

Normally, caches are self-managing, with the updates occurring automatically. Whenever the processor wants to access a cacheable location, the cache is checked. If the access is a cache hit, the access occurs immediately, otherwise a location is allocated and the cache line loaded from memory. Different cache topologies and access policies are possible, however, they must comply with the memory coherency model of the underlying architecture.

Caches introduce a number of potential problems, mainly because of:

- Memory accesses occurring at times other than when the programmer would normally expect them
- There being multiple physical locations where a data item can be held

A3.8.2 Implication of caches to the application programmer

Caches are largely invisible to the application programmer, but can become visible due to a breakdown in coherency. Such a breakdown can occur:

- When memory locations are updated by other agents in the systems
- When memory updates made from the application code must be made visible to other agents in the system

For example:

In systems with a DMA that reads memory locations which are held in the data cache of a processor, a breakdown of coherency occurs when the processor has written new data in the data cache, but the DMA reads the old data held in memory.

In a Harvard architecture of caches, a breakdown of coherency occurs when new instruction data has been written into the data cache and/or to memory, but the instruction cache still contains the old instruction data.

A3.9 Bit banding

ARMv7-M supports bit-banding. This feature is designed to be used with on-chip RAM or peripherals. A bit-band address space means that the address space supports bit-wise as well as (multi)byte accesses through an aliased address range. Byte, halfword, word and multi-byte accesses are supported by the primary address range associated with the bit-band memory in accordance with the memory type attribute associated with the address range. The aliased address range maps a word of address space (four bytes) to each bit.

For a detailed explanation of bit banding, see *Bit Banding* on page B2-5.

———— **Note** —————

Where a primary bit-band region is supported in the system memory map, the associated aliased bit-band region must be supported. Where no primary region support exists, the corresponding aliased region must also behave as non-existent memory.

—————

Chapter A4

The Thumb Instruction Set

This chapter describes the Thumb® instruction set. It contains the following sections:

- *Instruction set encoding* on page A4-2
- *Instruction encoding for 32-bit Thumb instructions* on page A4-12
- *Conditional execution* on page A4-33
- *UNDEFINED and UNPREDICTABLE instruction set space* on page A4-37
- *Usage of 0b1111 as a register specifier* on page A4-39
- *Usage of 0b1101 as a register specifier* on page A4-41

A4.1 Instruction set encoding

Thumb instructions are either 16-bit or 32-bit. Bits<15:11> of the halfword that the PC points to determine whether it is a 16-bit instruction, or whether the following halfword is the second part of a 32-bit instruction.

Table A4-1 shows how the instruction set space is divided between 16-bit and 32-bit instructions. An x in the encoding indicates any bit, except that any combination of bits already defined is excluded.

Table A4-1 Determination of instruction length

hw1<15:11>	Function
0b11100	Thumb 16-bit unconditional branch instruction, defined in all Thumb architectures.
0b111xx	Thumb 32-bit instructions, defined in Thumb-2, see <i>Instruction encoding for 32-bit Thumb instructions</i> on page A4-12.
0bxxxxx	Thumb 16-bit instructions.

A4.2 Instruction encoding for 16-bit Thumb instructions

Figure A4-1 shows the main divisions of the Thumb 16-bit instruction set space. An entry in square brackets, for example [1], indicates a note below the table.

	15	14	13	12	11	10	9	8	7	6	5	4	3	2	1	0
Shift by immediate, move register	0	0	0	opcode [1]			imm5				Rm		Rd			
Add/subtract register	0	0	0	1	1	0	opc	Rm			Rn		Rd			
Add/subtract immediate	0	0	0	1	1	1	opc	imm3			Rn		Rd			
Add/subtract/compare/move immediate	0	0	1	opcode			Rdn			imm8						
Data-processing register	0	1	0	0	0	0	opcode			Rm		Rdn				
Special data processing	0	1	0	0	0	1	opcode [1]	DN	Rm			Rdn				
Branch/exchange instruction set	0	1	0	0	0	1	1	1	L	Rm			(0) (0) (0)			
Load from literal pool	0	1	0	0	1	Rd			PC-relative imm8							
Load/store register offset	0	1	0	1	opcode			Rm			Rn		Rd			
Load/store word/byte immediate offset	0	1	1	B	L	imm5				Rn		Rd				
Load/store halfword immediate offset	1	0	0	0	L	imm5				Rn		Rd				
Load from or store to stack	1	0	0	1	L	Rd			SP-relative imm8							
Add to SP or PC	1	0	1	0	SP	Rd			imm8							
Miscellaneous [3]	1	0	1	1	x	x	x	x	x	x	x	x	x	x	x	x
Load/store multiple	1	1	0	0	L	Rn			register list							
Conditional branch	1	1	0	1	cond [2]				imm8							
Undefined instruction	1	1	0	1	1	1	1	0	x	x	x	x	x	x	x	x
Service (system) call	1	1	0	1	1	1	1	1	imm8							
Unconditional branch	1	1	1	0	0	imm11										
32-bit instruction	1	1	1	0	1	x	x	x	x	x	x	x	x	x	x	x
32-bit instruction	1	1	1	1	x	x	x	x	x	x	x	x	x	x	x	x

Figure A4-1 Thumb instruction set overview

1. opcode != 0b11.
2. cond != 0b111x.
3. See *Miscellaneous instructions* on page A4-9.

For further information about these instructions, see:

- Table A4-2 for shift (by immediate) and move (register) instructions
- Table A4-3 for add and subtract (register) instructions
- Table A4-4 on page A4-5 for add and subtract (3-bit immediate) instructions
- Table A4-5 on page A4-5 for add, subtract, compare and move (8-bit immediate) instructions
- Table A4-6 on page A4-6 for data processing (register) instructions
- Table A4-7 on page A4-6 for special data processing instructions
- Table A4-8 on page A4-7 for branch and exchange instruction set instructions
- *LDR (literal)* on page A5-105 for load from literal pool instructions
- Table A4-9 on page A4-7 for load and store (register offset) instructions
- Table A4-10 on page A4-7 for load and store, word or byte (immediate offset) instructions
- Table A4-11 on page A4-7 for load and store, halfword (immediate offset) instructions
- Table A4-12 on page A4-8 for load from or store to stack instructions
- Table A4-13 on page A4-8 for add 8-bit immediate to SP or PC instructions
- *Miscellaneous instructions* on page A4-9 for miscellaneous instructions
- Table A4-14 on page A4-8 for load and store multiple instructions
- *B* on page A5-40 for conditional branch instructions
- *SVC (formerly SWI)* on page A5-285 for service (system) call instructions
- *B* on page A5-40 for unconditional branch instructions.

Table A4-2 Shift by immediate and move (register) instructions

Function	Instruction	opcode	imm5
Move register (not in IT block)	<i>MOV (register)</i> on page A5-169	0b00	0b00000
Logical shift left	<i>LSL (immediate)</i> on page A5-151	0b00	!= 0b00000
Logical shift right	<i>LSR (immediate)</i> on page A5-155	0b01	any
Arithmetic shift right	<i>ASR (immediate)</i> on page A5-36	0b10	any

Table A4-3 Add and subtract (register) instructions

Function	Instruction	opc
Add register	<i>ADD (register)</i> on page A5-24	0b0
Subtract register	<i>SUB (register)</i> on page A5-279	0b1

Table A4-4 Add and subtract (3-bit immediate) instructions

Function	Instruction	opc
Add immediate	<i>ADD (immediate)</i> on page A5-21	0b0
Subtract immediate	<i>SUB (immediate)</i> on page A5-276	0b1

Table A4-5 Add, subtract, compare, and move (8-bit immediate) instructions

Function	Instruction	opcode
Move immediate	<i>MOV (immediate)</i> on page A5-167	0b00
Compare immediate	<i>CMP (immediate)</i> on page A5-73	0b01
Add immediate	<i>ADD (immediate)</i> on page A5-21	0b10
Subtract immediate	<i>SUB (immediate)</i> on page A5-276	0b11

Table A4-6 Data processing (register) instructions

Function	Instruction	opcode
Bitwise AND	<i>AND (register)</i> on page A5-34	0b0000
Bitwise Exclusive OR	<i>EOR (register)</i> on page A5-88	0b0001
Logical Shift Left	<i>LSL (register)</i> on page A5-153	0b0010
Logical Shift Right	<i>LSR (register)</i> on page A5-157	0b0011
Arithmetic shift right	<i>ASR (register)</i> on page A5-38	0b0100
Add with carry	<i>ADC (register)</i> on page A5-19	0b0101
Subtract with Carry	<i>SBC (register)</i> on page A5-230	0b0110
Rotate Right	<i>ROR (register)</i> on page A5-220	0b0111
Test	<i>TST (register)</i> on page A5-301	0b1000
Reverse subtract (from zero)	<i>RSB (immediate)</i> on page A5-224	0b1001
Compare	<i>CMP (register)</i> on page A5-75	0b1010
Compare Negative	<i>CMN (register)</i> on page A5-71	0b1011
Logical OR	<i>ORR (register)</i> on page A5-196	0b1100
Multiply	<i>MUL</i> on page A5-180	0b1101
Bit Clear	<i>BIC (register)</i> on page A5-49	0b1110
Move Negative	<i>MVN (register)</i> on page A5-184	0b1111

Table A4-7 Special data processing instructions

Function	Instruction	opcode
Add (register, including high registers)	<i>ADD (register)</i> on page A5-24	0b00
Compare (register, including high registers)	<i>CMP (register)</i> on page A5-75	0b01
Move (register, including high registers)	<i>MOV (register)</i> on page A5-169	0b10

Table A4-8 Branch and exchange instruction set instructions

Function	Instruction	L
Branch and Exchange	<i>BX</i> on page A5-57	0b0
Branch with Link and Exchange	<i>BLX (register)</i> on page A5-55	0b1

Table A4-9 Load and store (register offset) instructions

Function	Instruction	opcode
Store word	<i>STR (register)</i> on page A5-252	0b000
Store halfword	<i>STRH (register)</i> on page A5-270	0b001
Store byte	<i>STRB (register)</i> on page A5-256	0b010
Load signed byte	<i>LDRSB (register)</i> on page A5-137	0b011
Load word	<i>LDR (register)</i> on page A5-107	0b100
Load unsigned halfword	<i>LDRH (register)</i> on page A5-129	0b101
Load unsigned byte	<i>LDRB (register)</i> on page A5-113	0b110
Load signed halfword	<i>LDRSH (register)</i> on page A5-145	0b111

Table A4-10 Load and store, word or byte (5-bit immediate offset) instructions

Function	Instruction	B	L
Store word	<i>STR (immediate)</i> on page A5-250	0b0	0b0
Load word	<i>LDR (immediate)</i> on page A5-102	0b0	0b1
Store byte	<i>STRB (immediate)</i> on page A5-254	0b1	0b0
Load byte	<i>LDRB (immediate)</i> on page A5-109	0b1	0b1

Table A4-11 Load and store halfword (5-bit immediate offset) instructions

Function	Instruction	L
Store halfword	<i>STRH (immediate)</i> on page A5-268	0b0
Load halfword	<i>LDRH (immediate)</i> on page A5-125	0b1

Table A4-12 Load from stack and store to stack instructions

Function	Instruction	L
Store to stack	<i>STR (immediate)</i> on page A5-250	0b0
Load from stack	<i>LDR (immediate)</i> on page A5-102	0b1

Table A4-13 Add 8-bit immediate to SP or PC instructions

Function	Instruction	SP
Add (PC plus immediate)	<i>ADR</i> on page A5-30	0b0
Add (SP plus immediate)	<i>ADD (SP plus immediate)</i> on page A5-26	0b1

Table A4-14 Load and store multiple instructions

Function	Instruction	L
Store multiple	<i>STMIA / STMEA</i> on page A5-248	0b0
Load multiple	<i>LDMIA / LDMFD</i> on page A5-99	0b1

A4.2.1 Miscellaneous instructions

Figure A4-2 lists miscellaneous Thumb instructions. An entry in square brackets, for example [1], indicates a note below the figure.

	15	14	13	12	11	10	9	8	7	6	5	4	3	2	1	0
Adjust stack pointer	1	0	1	1	0	0	0	0	opc	imm7						
Sign/zero extend	1	0	1	1	0	0	1	0	opc	Rm			Rd			
Compare and Branch on (Non-)Zero	1	0	1	1	N	0	i	1	imm5				Rn			
Push/pop register list	1	0	1	1	L	1	0	R	register list							
UNPREDICTABLE	1	0	1	1	0	1	1	0	0	1	0	0	x	x	x	x
Change Processor State	1	0	1	1	0	1	1	0	0	1	1	im	0	(0)	I	F
UNPREDICTABLE	1	0	1	1	0	1	1	0	0	1	1	x	1	x	x	x
Reverse bytes	1	0	1	1	1	0	1	0	opc	Rn			Rd			
Software breakpoint	1	0	1	1	1	1	1	0	imm8							
If-Then instructions	1	0	1	1	1	1	1	1	cond				mask (!= 0b0000)			
NOP-compatible hints	1	0	1	1	1	1	1	1	hint				0	0	0	0

Figure A4-2 Miscellaneous Thumb instructions

Note

Any instruction with bits<15:12> = 1011, that is not shown in Figure A4-2, is an UNDEFINED instruction.

For further information about these instructions, see:

- Table A4-15 on page A4-10 for adjust stack pointer instructions
- Table A4-16 on page A4-10 for sign or zero extend instructions
- Table A4-17 on page A4-10 for compare (non-)zero and branch instructions
- Table A4-18 on page A4-10 for push and pop instructions
- *CPS* on page A5-77 for the change processor state instruction
- Table A4-19 on page A4-11 for reverse bytes instructions
- *BKPT* on page A5-51 for the software breakpoint instruction
- *IT* on page A5-92 for the If-Then instruction
- Table A4-20 on page A4-11 for NOP-compatible hint instructions.

Table A4-15 Adjust stack pointer instructions

Function	Instruction	opc
Increment stack pointer	<i>ADD (SP plus immediate)</i> on page A5-26	0b0
Decrement stack pointer	<i>SUB (SP minus immediate)</i> on page A5-281	0b1

Table A4-16 Sign or zero extend instructions

Function	Instruction	opc
Signed Extend Halfword	<i>SXTH</i> on page A5-289	0b00
Signed Extend Byte	<i>SXTB</i> on page A5-287	0b01
Unsigned Extend Halfword	<i>UXTH</i> on page A5-315	0b10
Unsigned Extend Byte	<i>UXTB</i> on page A5-313	0b11

Table A4-17 Compare and branch on (non-)zero instructions

Function	Instruction	N
Compare and branch on zero	<i>CBZ</i> on page A5-61	0b0
Compare and branch on non-zero	<i>CBNZ</i> on page A5-59	0b1

Table A4-18 Push and pop instructions

Function	Instruction	L
Push registers	<i>PUSH</i> on page A5-208	0b0
Pop registers	<i>POP</i> on page A5-206	0b1

Table A4-19 Reverse byte instructions

Function	Instruction	opc
Byte-Reverse Word	<i>REV</i> on page A5-212	0b00
Byte-Reverse Packed Halfword	<i>REV16</i> on page A5-214	0b01
UNDEFINED	-	0b10
Byte-Reverse Signed Halfword	<i>REVSH</i> on page A5-216	0b11

Table A4-20 NOP-compatible hint instructions

Function	Instruction	hint
No operation	<i>NOP</i> on page A5-188	0b0000
Yield	<i>YIELD</i> on page A5-321	0b0001
Wait For Event	<i>WFE</i> on page A5-317	0b0010
Wait For Interrupt	<i>WFI</i> on page A5-319	0b0011
Send event	<i>SEV</i> on page A5-236	0b0100

A4.3 Instruction encoding for 32-bit Thumb instructions

Figure A4-3 shows the main divisions of the Thumb 32-bit instruction set space.

The following sections give further details of each instruction type shown in Figure A4-3.

	15	14	13	12	11	10	9	8	7	6	5	4	3	2	1	0	15	14	13	12	11	10	9	8	7	6	5	4	3	2	1	0
	hw1																hw2															
Data processing: immediate, including bitfield, and saturate	1	1	1	1	0											0																
Data processing, no immediate operand	1	1	1			1	0	1																								
Load and store single data item, memory hints	1	1	1	1	1	0	0																									
Load and Store, Double and Exclusive, and Table Branch	1	1	1	0	1	0	0			1																						
Load and Store Multiple, RFE and SRS	1	1	1	0	1	0	0			0																						
Branches, miscellaneous control	1	1	1	1	0											1																
Coprocessor	1	1	1														1	1	1	1												

Figure A4-3 Thumb 32-bit instruction set summary

This section contains the following subsections:

- *Data processing instructions: immediate, including bitfield and saturate* on page A4-13
- *Data processing instructions, non-immediate* on page A4-18
- *Load and store single data item, and memory hints* on page A4-25
- *Load/store double and exclusive, and table branch* on page A4-27
- *Load and store multiple* on page A4-29
- *Branches, miscellaneous control instructions* on page A4-30
- *Coprocessor instructions* on page A4-32.

A4.3.1 Data processing instructions: immediate, including bitfield and saturate

Figure A4-4 shows the encodings for:

- data processing instructions with an immediate operand
- data processing instructions with bitfield or saturating operations.

	hw1																hw2																					
	15	14	13	12	11	10	9	8	7	6	5	4	3	2	1	0	15	14	13	12	11	10	9	8	7	6	5	4	3	2	1	0						
General format	1	1	1	1	0																	0																
Data processing, modified 12-bit immediate	1	1	1	1	0	i	0	OP				S	Rn				0	imm3			Rd			imm8														
Add, Subtract, plain 12-bit immediate	1	1	1	1	0	i	1	0	OP		0	OP2				Rn				0	imm3			Rd			imm8											
Move, plain 16-bit immediate	1	1	1	1	0	i	1	0	OP		1	OP2				imm4				0	imm3			Rd			imm8											
Bit field operations, Saturation with shift	1	1	1	1	0	(0)	1	1	OP		0	Rn				0	imm3			Rd			imm2		(0)	imm5												
Reserved	1	1	1	1	0	1		1					1					0																				

Figure A4-4 Data processing instructions: immediate, bitfield, and saturating

This section contains the following subsections:

- *Data processing instructions with modified 12-bit immediate* on page A4-14
- *Data processing instructions with plain 12-bit immediate* on page A4-16
- *Data processing instructions with plain 16-bit immediate* on page A4-16
- *Data processing instructions, bitfield and saturate* on page A4-17.

Data processing instructions with modified 12-bit immediate

Table A4-21 gives the opcodes and locations of further information about the data processing instructions with modified 12-bit immediate data. For information about modified 12-bit immediate data, see *Immediate constants* on page A5-8.

In these instructions, if the S bit is set, the instruction updates the condition code flags according to the results of the instruction, see *Conditional execution* on page A4-33.

Table A4-21 Data processing instructions with modified 12-bit immediate

Function	Instruction	OP	Notes
Add with carry	<i>ADC (immediate)</i> on page A5-17	0b1010	
Add	<i>ADD (immediate)</i> on page A5-21	0b1000	
Logical AND	<i>AND (immediate)</i> on page A5-32	0b0000	
Bit clear	<i>BIC (immediate)</i> on page A5-47	0b0001	
Compare negative	<i>CMN (immediate)</i> on page A5-69	0b1000	ADD with Rd == 0b1111, S == 1
Compare	<i>CMP (immediate)</i> on page A5-73	0b1101	SUB with Rd == 0b1111, S == 1
Exclusive OR	<i>EOR (immediate)</i> on page A5-86	0b0100	
Move	<i>MOV (immediate)</i> on page A5-167	0b0010	ORR with Rn == 0b1111
Move negative	<i>MVN (immediate)</i> on page A5-182	0b0011	ORN with Rn == 0b1111
Logical OR NOT	<i>ORN (immediate)</i> on page A5-190	0b0011	
Logical OR	<i>ORR (immediate)</i> on page A5-194	0b0010	
Reverse subtract	<i>RSB (immediate)</i> on page A5-224	0b1110	
Subtract with carry	<i>SBC (immediate)</i> on page A5-228	0b1011	

Table A4-21 Data processing instructions with modified 12-bit immediate (continued)

Function	Instruction	OP	Notes
Subtract	<i>SUB (immediate)</i> on page A5-276	0b1101	
Test equal	<i>TEQ (immediate)</i> on page A5-295	0b0100	EOR with Rd == 0b1111, S == 1
Test	<i>TST (immediate)</i> on page A5-299	0b0000	AND with Rd == 0b1111, S == 1

Instructions of this format using any other combination of the OP bits are UNDEFINED.

Data processing instructions with plain 12-bit immediate

Table A4-22 gives the opcodes and locations of further information about the data processing instructions with plain 12-bit immediate data.

In these instructions, the immediate value is in $i : imm3 : imm8$.

Table A4-22 Data processing instructions with plain 12-bit immediate

Function	Instruction	OP	OP2
Add wide	<i>ADD (immediate)</i> on page A5-21, encoding T4	0	0b00
Subtract wide	<i>SUB (immediate)</i> on page A5-276, encoding T4	1	0b10
Address (before current instruction)	<i>ADR</i> on page A5-30, encoding T2	0	0b10
Address (after current instruction)	<i>ADR</i> on page A5-30, encoding T3	1	0b00

Instructions of this format using any other combination of the OP and OP2 bits are UNDEFINED.

Data processing instructions with plain 16-bit immediate

Table A4-23 gives the opcodes and locations of further information about the data processing instructions with plain 16-bit immediate data.

In these instructions, the immediate value is in $imm4 : i : imm3 : imm8$.

Table A4-23 Data processing instructions with plain 16-bit immediate

Function	Instruction	OP	OP2
Move top	<i>MOVT</i> on page A5-172	1	0b00
Move wide	<i>MOV (immediate)</i> on page A5-167, encoding T3	0	0b00

Instructions of this format using any other combination of the OP and OP2 bits are UNDEFINED.

Data processing instructions, bitfield and saturate

Table A4-24 gives the opcodes and locations of further information about saturation, bitfield extract, clear, and insert instructions.

Table A4-24 Miscellaneous data processing instructions

Function	Instruction	OP	Notes
Bit Field Clear	<i>BFC</i> on page A5-43	0b011	Rn == 0b1111, meaning #0
Bit Field Insert	<i>BFI</i> on page A5-45	0b011	
Signed Bit Field extract	<i>SBFX</i> on page A5-232	0b010	
Signed saturate, LSL	<i>SSAT</i> on page A5-242	0b000	
Signed saturate, ASR	<i>SSAT</i> on page A5-242	0b001	
Unsigned Bit Field extract	<i>UBFX</i> on page A5-303	0b110	
Unsigned saturate, LSL	<i>USAT</i> on page A5-311	0b100	
Unsigned saturate, ASR	<i>USAT</i> on page A5-311	0b101	

Instructions of this format using any other combination of the OP bits are UNDEFINED.

A4.3.2 Data processing instructions, non-immediate

Figure A4-5 shows the encodings for data processing instructions without an immediate operand.

In these instructions, if the S bit is set, the instruction updates the condition code flags according to the results of the instruction, see *Conditional execution* on page A4-33.

	h w 1																h w 2															
	15	14	13	12	11	10	9	8	7	6	5	4	3	2	1	0	15	14	13	12	11	10	9	8	7	6	5	4	3	2	1	0
General format	1	1	1		1	0	1																									
Data processing: constant shift	1	1	1	0	1				OP	S	Rn	(0)	imm3	Rd	imm2	type	Rm															
Register-controlled shift	1	1	1	1	1	0	1	0	0	OP	S	Rn	1	1	1	1	Rd	0	OP2	Rm												
Sign or zero extension, with optional addition	1	1	1	1	1	0	1	0	0	OP		Rn	1	1	1	1	Rd	1	(0)	rot	Rm											
SIMD add or subtract	1	1	1	1	1	0	1	0	1	OP		Rn	1	1	1	1	Rd	0	prefix	Rm												
Other three register data processing	1	1	1	1	1	0	1	0	1	OP		Rn	1	1	1	1	Rd	1	OP2	Rm												
Reserved	1	1	1	1	1	0	1	0	Not 1111																							
32-bit multiplies and Sum of absolute differences, with or without accumulate	1	1	1	1	1	0	1	1	0	OP		Rn	Racc	Rd			OP2	Rm														
64-bit multiplies and multiply-accumulates. Divides.	1	1	1	1	1	0	1	1	1	OP		Rn	RdLo	RdHi			OP2	Rm														

Figure A4-5 Data processing instructions, non-immediate

This section contains the following subsections:

- *Data processing instructions with constant shift* on page A4-19
- *Register-controlled shift instructions* on page A4-20
- *Signed and unsigned extend instructions with optional addition* on page A4-21
- *Other three-register data processing instructions* on page A4-22
- *32-bit multiplies, with or without accumulate* on page A4-23
- *64-bit multiply, multiply-accumulate, and divide instructions* on page A4-24.

Data processing instructions with constant shift

Table A4-25 gives the opcodes and locations of further information about the data processing instructions with a constant shift applied to the second operand register. For information about constant shifts, see *Constant shifts applied to a register* on page A5-10.

In these instructions, if the S bit is set, the instruction updates the condition code flags according to the results of the instruction, see *Conditional execution* on page A4-33.

The shift type is encoded in hw2<5:4>. The shift value is encoded in hw2<14:12,7:6>.

Table A4-25 Data processing instructions with constant shift

Function	Instruction	OP	Notes
Add with carry	<i>ADC (register)</i> on page A5-19	0b1010	
Add	<i>ADD (register)</i> on page A5-24	0b1000	
Logical AND	<i>AND (register)</i> on page A5-34	0b0000	
Bit clear	<i>BIC (register)</i> on page A5-49	0b0001	
Compare negative	<i>CMN (register)</i> on page A5-71	0b1000	ADD with Rd == 0b1111, S == 1
Compare	<i>CMP (register)</i> on page A5-75	0b1101	SUB with Rd == 0b1111, S == 1
Exclusive OR	<i>EOR (register)</i> on page A5-88	0b0100	
Move, and immediate shift	<i>Move, and immediate shift instructions</i> on page A4-20	0b0010	ORR with Rn == 0b1111
Move negative	<i>MVN (register)</i> on page A5-184	0b0011	ORN with Rn == 0b1111
Logical OR NOT	<i>ORN (register)</i> on page A5-192	0b0011	
Logical OR	<i>ORR (register)</i> on page A5-196	0b0010	
Reverse subtract	<i>RSB (register)</i> on page A5-226	0b1110	
Subtract with carry	<i>SBC (register)</i> on page A5-230	0b1011	
Subtract	<i>SUB (register)</i> on page A5-279	0b1101	
Test equal	<i>TEQ (register)</i> on page A5-297	0b0100	EOR with Rd == 0b1111, S == 1
Test	<i>TST (register)</i> on page A5-301	0b0000	AND with Rd == 0b1111, S == 1

Instructions of this format using any other combination of the OP bits are UNDEFINED.

Instructions of this format with OP == 0b0110 are UNDEFINED if S == 1 or shift_type == 0b01 or shift_type == 0b11.

Move, and immediate shift instructions

Table A4-26 gives the locations of further information about the move, and immediate shift instructions.

In these instructions, if the S bit is set, the instruction updates the condition code flags according to the results of the instruction, see *Conditional execution* on page A4-33.

Table A4-26 Move, and immediate shift instructions

Function	Instruction	type	imm5
Move	<i>MOV (register)</i> on page A5-169	0b00	0b00000
Logical Shift Left	<i>LSL (immediate)</i> on page A5-151	0b00	not 0b00000
Logical Shift Right	<i>LSR (immediate)</i> on page A5-155	0b01	any
Arithmetic Shift Right	<i>ASR (immediate)</i> on page A5-36	0b10	any
Rotate Right	<i>ROR (immediate)</i> on page A5-218	0b11	not 0b00000
Rotate Right with Extend	<i>RRX</i> on page A5-222	0b11	0b00000

Register-controlled shift instructions

Table A4-27 gives the opcodes and locations of further information about the register-controlled shift instructions.

In these instructions, if the S bit is set, the instruction updates the condition code flags according to the results of the instruction, see *Conditional execution* on page A4-33.

Table A4-27 Register-controlled shift instructions

Function	Instruction	type	OP
Logical Shift Left	<i>LSL (register)</i> on page A5-153	0b00	0b000
Logical Shift Right	<i>LSR (register)</i> on page A5-157	0b01	0b000
Arithmetic Shift Right	<i>ASR (register)</i> on page A5-38	0b10	0b000
Rotate Right	<i>ROR (register)</i> on page A5-220	0b11	0b000

Instructions of this format using any other combination of the OP and OP2 bits are UNDEFINED.

Signed and unsigned extend instructions with optional addition

Table A4-28 gives the opcodes and locations of further information about the signed and unsigned (zero) extend instructions with optional addition.

Table A4-28 Signed and unsigned extend instructions with optional addition

Function	Instruction	OP	Rn
Signed extend byte	<i>SXTB</i> on page A5-287	0b100	0b1111
Signed extend halfword	<i>SXTH</i> on page A5-289	0b000	0b1111
Unsigned extend byte	<i>UXTB</i> on page A5-313	0b101	0b1111
Unsigned extend halfword	<i>UXTH</i> on page A5-315	0b001	0b1111

Instructions of this format using any other combination of the OP bits are UNDEFINED.

Other three-register data processing instructions

Table A4-29 gives the opcodes and locations of further information about other three-register data processing instructions.

Table A4-29 Other three-register data processing instructions

Function	Instruction	OP	OP2
Count Leading Zeros	<i>CLZ</i> on page A5-67	0b011	0b000
Reverse Bits	<i>RBIT</i> on page A5-210	0b001	0b010
Byte-Reverse Word	<i>REV</i> on page A5-212	0b001	0b000
Byte-Reverse Packed Halfword	<i>REV16</i> on page A5-214	0b001	0b001
Byte-Reverse Signed Halfword	<i>REVSH</i> on page A5-216	0b001	0b011

Instructions of this format using any other combination of the OP and OP2 bits are UNDEFINED.

32-bit multiplies, with or without accumulate

Table A4-30 gives the opcodes and locations of further information about multiply and multiply-accumulate instructions with 32-bit results, and absolute difference and accumulate absolute difference instructions.

Table A4-30 Other two-register data processing instructions

Function	Instruction	OP	OP2	Ra
32 + 32 x 32-bit, least significant word	<i>MLA</i> on page A5-163	0b000	0b0000	not R15
32 – 32 x 32-bit, least significant word	<i>MLS</i> on page A5-165	0b000	0b0001	not R15
32 x 32-bit, least significant word	<i>MUL</i> on page A5-180	0b000	0b0000	0b1111

Instructions of this format using any other combination of the OP and OP2 bits are UNDEFINED.

An instruction that matches the OP and OP2 fields, but not the Ra column, is UNPREDICTABLE under the usage rules for R15.

64-bit multiply, multiply-accumulate, and divide instructions

Table A4-31 gives the opcodes and locations of further information about multiply and multiply accumulate instructions with 64-bit results, and divide instructions.

Table A4-31 Other two-register data processing instructions

Function	Instruction	OP	OP2
Signed 32 x 32	<i>SMULL</i> on page A5-240	0b000	0b0000
Signed divide	<i>SDIV</i> on page A5-234	0b001	0b1111
Unsigned 32 x 32	<i>UMULL</i> on page A5-309	0b010	0b0000
Unsigned divide	<i>UDIV</i> on page A5-305	0b011	0b1111
Signed 64 + 32 x 32	<i>SMLAL</i> on page A5-238	0b100	0b0000
Unsigned 64 + 32 x 32	<i>UMLAL</i> on page A5-307	0b110	0b0000

Instructions of this format using any other combination of the OP and OP2 bits are UNDEFINED.

Divide by Zero

ARMv7-M supports signed and unsigned integer divide instructions *SDIV* and *UDIV*.

The divide instructions can have divide-by-zero trapping enabled. Trapping is controlled by the *DIV_0_TRP* bit (see *The System Control Block (SCB)* on page B2-8).

- If *DIV_0_TRP* is clear, a division by zero produces a result of zero.
- If *DIV_0_TRP* is set, a division by zero causes a UsageFault exception to occur on the *SDIV* or *UDIV* instruction.

A4.3.3 Load and store single data item, and memory hints

Figure A4-6 shows the encodings for loads and stores with single data items.

	hw1																hw2																		
	15	14	13	12	11	10	9	8	7	6	5	4	3	2	1	0	15	14	13	12	11	10	9	8	7	6	5	4	3	2	1	0			
General format	1	1	1	1	1	0	0																												
PC +/- imm1	1	1	1	1	1	0	0	S	U	size	1	1	1	1	1	Rt	imm12																		
Rn + imm12	1	1	1	1	1	0	0	S	1	size	L			Rn	Rt	imm12																			
Rn - imm8	1	1	1	1	1	0	0	S	0	size	L			Rn	Rt	1	1	0	0	imm8															
Rn + imm8, User privilege	1	1	1	1	1	0	0	S	0	size	L			Rn	Rt	1	1	1	0	imm8															
Rn post-indexed by +/- imm8	1	1	1	1	1	0	0	S	0	size	L			Rn	Rt	1	0		1	imm8															
Rn pre-indexed by +/- imm8	1	1	1	1	1	0	0	S	0	size	L			Rn	Rt	1	1		1	imm8															
Rn + shifted register	1	1	1	1	1	0	0	S	0	size	L			Rn	Rt	0	0	0	0	0	0	0	0	shift	Rm										
RESERVED	1	1	1	1	1	0	0		0	Not 1111								1	0		0														
RESERVED	1	1	1	1	1	0	0		0	Not 1111								0	Not 00000																
RESERVED	1	1	1	1	1	0	0				0	1	1	1	1																				

Figure A4-6 Load and store instructions, single data item

In these instructions:

- L specifies whether the instruction is a load (L == 1) or a store (L == 0)
- S specifies whether a load is sign extended (S == 1) or zero extended (S == 0)
- U specifies whether the indexing is upwards (U == 1) or downwards (U == 0)
- Rn cannot be r15 (if it is, the instruction is PC +/- imm12)
- Rm cannot be r13 or r15 (if it is, the instruction is UNPREDICTABLE).

Table A4-32 gives the encoding and locations of further information about load and store single data item instructions, and memory hints.

Table A4-32 Load and store single data item, and memory hints

Instruction	Format	S	size	L	Rt
LDR, LDRB, LDRSB, LDRH, LDRSH (immediate offset)	2	X	0b0X	1	Not R15
		0	0b10	1	Any, including R15
LDR, LDRB, LDRSB, LDRH, LDRSH (negative immediate offset)	3	X	0b0X	1	Not R15
		0	0b10	1	Any, including R15
LDR, LDRB, LDRSB, LDRH, LDRSH (post-indexed)	5	X	0b0X	1	Not R15
		0	0b10	1	Any, including R15

Table A4-32 Load and store single data item, and memory hints (continued)

Instruction	Format	S	size	L	Rt
LDR, LDRB, LDRSB, LDRH, LDRSH (pre-indexed)	6	X	0b0X	1	Not R15
		0	0b10	1	Any, including R15
LDR, LDRB, LDRSB, LDRH, LDRSH (register offset)	7	X	0b0X	1	Not R15
		0	0b10	1	Any, including R15
LDR, LDRB, LDRSB, LDRH, LDRSH (PC-relative)	1	X	0b0X	1	Not R15
		0	0b10	1	Any, including R15
LDRT, LDRBT, LDRSBT, LDRHT, LDRSHT	4	X	0b0X	1	Not R15
		0	0b10	1	Not R15
PLD	1, 2, 3, 7	0	0b00	1	R15
PLI	1, 2, 3, 7	1	0b00	1	R15
Unallocated memory hints (execute as NOP)	1, 2, 3, 7	X	0b01	1	R15
UNPREDICTABLE	4, 5, 6	X	0b0X	1	R15
STR, STRB, STRH (immediate offset) on page 4-245	2	0	Not 0b11	0	Not R15
STR, STRB, STRH (negative immediate offset) on page 4-247	3	0	Not 0b11	0	Not R15
STR, STRB, STRH (post-indexed) on page 4-249	5	0	Not 0b11	0	Not R15
STR, STRB, STRH (pre-indexed) on page 4-251	6	0	Not 0b11	0	Not R15
STR, STRB, STRH (register offset) on page 4-253	7	0	Not 0b11	0	Not R15
STRT, STRBT, STRHT on page 4-268	4	0	Not 0b11	0	Not R15

Instruction encodings using any combination of Format, S, size, and L bits that is not covered by Table A4-32 on page A4-25 are UNDEFINED.

An instruction that matches the Format, S, and L fields, but not the Rt column, is UNPREDICTABLE under the usage rules for R15.

A4.3.4 Load/store double and exclusive, and table branch

Figure A4-7 shows the encodings for load and store double, load and store exclusive, and table branch instructions.

	15	14	13	12	11	10	9	8	7	6	5	4	3	2	1	0	15	14	13	12	11	10	9	8	7	6	5	4	3	2	1	0
	h w 1																h w 2															
General format	1	1	1	0	1	0	0									1																
Load and Store Double (only if PW != 0b00)	1	1	1	0	1	0	0	P	U	1	W	L			Rn	Rt	Rt2	imm8														
Load and Store Exclusive	1	1	1	0	1	0	0	0	0	1	0	L			Rn	Rt	Rd	imm8														
Load and Store Exclusive Byte, Halfword, and Table Branch.	1	1	1	0	1	0	0	0	1	1	0	L			Rn	Rt	Rt2	OP	Rm													

Figure A4-7 Load and store double, load and store exclusive, and table branch

In these instructions:

- L specifies whether the instruction is a load (L == 1) or a store (L == 0)
- P specifies pre-indexed addressing (P == 1) or post-indexed addressing (P == 0)
- U specifies whether the indexing is upwards (U == 1) or downwards (U == 0)
- W specifies whether the address is written back to the base register (W == 1) or not (W == 0).

For further details about the load and store double instructions, see:

- *LDRD (immediate)* on page A5-117
- *STRD (immediate)* on page A5-260.

For further details about the load and store exclusive word instructions, see:

- *LDREX* on page A5-119
- *STREX* on page A5-262.

Table A4-33 on page A4-28 gives details of the encoding of load and store exclusive byte and halfword, and the table branch instructions.

Table A4-33 Load and store exclusive byte, halfword, and doubleword, and table branch instructions

Instruction	L	OP	Rn	Rt	Rt2	Rm
<i>LDREXB</i> on page A5-121	1	0b0100	Not R15	Not R15	SBO	SBO
<i>LDREXH</i> on page A5-123	1	0b0101	Not R15	Not R15	SBO	SBO
<i>STREXB</i> on page A5-264	0	0b0100	Not R15	Not R15	SBO	Not R15
<i>STREXH</i> on page A5-266	0	0b0101	Not R15	Not R15	SBO	Not R15
<i>TBB</i> on page A5-291	1	0b0000	Any including R15	SBO	SBZ	Not R15
<i>TBH</i> on page A5-293	1	0b0001	Any including R15	SBO	SBZ	Not R15

Instructions of this format using any other combination of the L and OP bits are UNDEFINED.

An instruction that matches the OP and L fields, but not the Rn, Rm, Rt, or Rt2 columns, is UNPREDICTABLE under the usage rules for R15.

A4.3.5 Load and store multiple

Figure A4-8 shows encodings for the load and store multiple instructions, together with the RFE and SRS instructions.

	hw1										hw2																					
	15	14	13	12	11	10	9	8	7	6	5	4	3	2	1	0	15	14	13	12	11	10	9	8	7	6	5	4	3	2	1	0
General format	1	1	1	0	1	0	0			0																						
Load and Store Multiple	1	1	1	0	1	0	0	V	U	0	W	L	Rn			P	M	(0)	mask													
RESERVED	1	1	1	0	1	0	0	U	U	0																						

Figure A4-8 Load and store multiple, RFE, and SRS

In these instructions:

- L specifies whether the instruction is a load (L == 1) or a store (L == 0)
- mask specifies which registers, in the range R0-R12, must be loaded or stored
- M specifies whether R14 is to be loaded or stored
- P specifies whether the PC is to be loaded (the PC cannot be stored)
- U specifies whether the indexing is upwards (U == 1) or downwards (U == 0)
- V is NOT U
- W specifies whether the address is written back to the base register (W == 1) or not (W == 0).

For further details about these instructions, see:

- *LDMDB / LDMEA* on page A5-97 (Load Multiple Decrement Before / Empty Ascending)
- *LDMIA / LDMFD* on page A5-99 (Load Multiple Increment After / Full Descending)
- *POP* on page A5-206
- *PUSH* on page A5-208
- *STMDB / STMFD* on page A5-246 (Store Multiple Decrement Before / Full Descending)
- *STMIA / STMEA* on page A5-248 (Store Multiple Increment After / Empty Ascending).

A4.3.6 Branches, miscellaneous control instructions

Figure A4-9 shows the encodings for branches and various control instructions.

	hw1															hw2																				
	15	14	13	12	11	10	9	8	7	6	5	4	3	2	1	0	15	14	13	12	11	10	9	8	7	6	5	4	3	2	1	0				
General format	1	1	1	1	0																1															
Branch	1	1	1	1	0	S	offset[21:12]										1	0	J1	1	J2	offset[11:1]														
Branch with link	1	1	1	1	0	S	offset[21:12]										1	1	J1	1	J2	offset[11:1]														
Conditional branch	1	1	1	1	0	S	cond			offset[17:12]										1	0	J1	0	J2	offset[11:1]											
Move to status from register	1	1	1	1	0	0	1	1	1	0	0	0	Rn	1	0	(0)	0	1	0	0	0	SYSm														
No operation, hints	1	1	1	1	0	0	1	1	1	0	1	0	(1)(1)(1)(1)	1	0	(0)	0	(0)	0	0	0	hint														
Special control operations	1	1	1	1	0	0	1	1	1	0	1	1	(1)(1)(1)(1)	1	0	(0)	0	(1)(1)(1)(1)	OP	option																
Move to register from status	1	1	1	1	0	0	1	1	1	1	1	0	(1)(1)(1)(1)	1	0	(0)	0	Rd	SYSm																	
Permanently UNDEFINED	1	1	1	1	0	1	1	1	1	1	1			1	0	1	0		1 1 1 1																	

Figure A4-9 Branches and miscellaneous control instructions

In these instructions:

- I, F specifies which interrupt disable flags a CPS instruction must alter
- I1, I2 contain bits<23:22> of the offset, exclusive ORed with the S bit
- J1, J2 contain bits<19:18> of the offset
- M specifies whether a CPS instruction modifies the mode (M == 1) or not (M == 0)
- R specifies whether an MRS instruction accesses the SPSR (R== 1) or the CPSR (R == 0)
- S contains the sign bit, duplicated to bits<31:24> of the offset, or to bits<31:20> of the offset for conditional branches.

For further details about the No operation and hint instructions, see Table A4-34 on page A4-31.

For further details about the Special control operation instructions, see Table A4-35 on page A4-31.

For further details about the other branch and miscellaneous control instructions, see:

- *B* on page A5-40 (Branch)
- *BL* on page A5-53 (Branch with Link)
- *BLX (register)* on page A5-55 (Branch with Link and eXchange)
- *BX* on page A5-57 (Branch eXchange)
- *MRS* on page A5-178 (Move from Special-purpose register to ARM Register)
- *MSR (register)* on page A5-179 (Move from ARM register to Special-purpose Register)

Table A4-34 NOP-compatible hint instructions

Function	Hint number	For details see
No operation	0b00000000	<i>NOP</i> on page A5-188
Yield	0b00000001	<i>YIELD</i> on page A5-321
Wait for event	0b00000010	<i>WFE</i> on page A5-317
Wait for interrupt	0b00000011	<i>WFI</i> on page A5-319
Send event	0b00000100	<i>SEV</i> on page A5-236
Debug hint	0b1111xxxx	<i>DBG</i> on page A5-80

The remainder of this space is RESERVED. The instructions must execute as No Operations, and must not be used.

Table A4-35 Special control operations

Function	OP	For details see
Clear Exclusive	0b0010	<i>CLREX</i> on page A5-65
Data Synchronization Barrier	0b0100	<i>DSB</i> on page A5-84
Data Memory Barrier	0b0101	<i>DMB</i> on page A5-82
Instruction Synchronization Barrier	0b0110	<i>ISB</i> on page A5-90

Instructions of this format using any other combination of the OP bits are UNDEFINED.

A4.3.7 Coprocessor instructions

Figure A4-10 shows the encodings for coprocessor instructions.

	hw1											hw2																				
	15	14	13	12	11	10	9	8	7	6	5	4	3	2	1	0	15	14	13	12	11	10	9	8	7	6	5	4	3	2	1	0
General format	1	1	1			1	1																									
MRRC and MCRR coprocessor register transfers	1	1	1	C	1	1	0	0	0	1	0	L	Rt2	Rt	coproc	opcode	CRm															
Load and store coprocessor	1	1	1	C	1	1	0	P	U	N	W	L	Rn	CRd	coproc	imm8																
Coprocessor data processing	1	1	1	C	1	1	1	0	opc1			CRn	CRd	coproc	opc2	0	CRm															
MRC and MCR coprocessor register transfers	1	1	1	C	1	1	1	0	opc1		L	CRn	Rxf	coproc	opc2	1	CRm															
RESERVED	1	1	1		1	1	1	1																								

Figure A4-10 Coprocessor instructions

A4.4 Conditional execution

Most Thumb instructions are unconditional. Before Thumb-2, the only conditional Thumb instruction was a 16-bit conditional branch instruction, `B<cond>`, with a branch range of -256 to $+254$ bytes.

Thumb-2 adds the following instructions:

- A 32-bit conditional branch, with a branch range of approximately $\pm 1\text{MB}$, see *B* on page A5-40.
- A 16-bit If-Then instruction, `IT`. `IT` makes up to four following instructions conditional, see *IT* on page A5-92. The instructions that are made conditional by an `IT` instruction are called its *IT block*.
- A 16-bit Compare and Branch on Zero instruction, with a branch range of $+4$ to $+130$ bytes, see *CBZ* on page A5-61.
- A 16-bit Compare and Branch on Non-Zero instruction, with a branch range of $+4$ to $+130$ bytes, see *CBNZ* on page A5-59.

The condition codes that the conditional branch and `IT` instructions use are shown in Table A4-36 on page A4-34.

The conditions of the instructions in an `IT` block are either all the same, or some of them are the inverse of the first condition.

A4.4.1 Assembly language syntax

Although Thumb instructions are unconditional, all instructions that are made conditional by an `IT` instruction must be written with a condition. These conditions must match the conditions imposed by the `IT` instruction. For example, an `ITTEE EQ` instruction imposes the `EQ` condition on the first two following instructions, and the `NE` condition on the next two. Those four instructions must be written with `EQ`, `EQ`, `NE` and `NE` conditions respectively.

Some instructions are not allowed to be made conditional by an `IT` instruction, or are only allowed to be if they are the last instruction in the `IT` block.

The branch instruction encodings that include a condition field are not allowed to be made conditional by an *IT* instruction. If the assembler syntax indicates a conditional branch that correctly matches a preceding *IT* instruction, it must be assembled using a branch instruction encoding that does not include a condition field.

Table A4-36 Condition codes

Opcode	Mnemonic extension	Meaning	Condition flag state
0000	EQ	Equal	Z set
0001	NE	Not equal	Z clear
0010	CS ^a	Carry set	C set
0011	CC ^b	Carry clear	C clear
0100	MI	Minus/negative	N set
0101	PL	Plus/positive or zero	N clear
0110	VS	Overflow	V set
0111	VC	No overflow	V clear
1000	HI	Unsigned higher	C set and Z clear
1001	LS	Unsigned lower or same	C clear or Z set
1010	GE	Signed greater than or equal	N set and V set, or N clear and V clear (N == V)
1011	LT	Signed less than	N set and V clear, or N clear and V set (N != V)
1100	GT	Signed greater than	Z clear, and either N set and V set, or N clear and V clear (Z == 0, N == V)
1101	LE	Signed less than or equal	Z set, or N set and V clear, or N clear and V set (Z == 1 or N != V)
1110	AL	Always (unconditional). AL can only be used with <i>IT</i> instructions.	-
1111	-	Alternative instruction, always (unconditional).	-

a. HS (unsigned Higher or Same) is a synonym for CS.

b. LO (unsigned Lower) is a synonym for CC.

A4.4.2 The IT execution state bits

The IT bits are a system level resource defined in *The special-purpose processor status registers (xPSR)* on page B1-7. They are system level state bits associated with the IT instruction and conditional execution in Thumb-2. Their behavior is described here alongside the other information associated with conditional execution for completeness.

IT<7:5> encodes the *base condition* (that is, the top 3 bits of the condition specified by the IT instruction) for the current IT block, if any. It contains 0b000 when no IT block is active.

IT<4:0> encodes the number of instructions that are due to be conditionally executed, and whether the condition for each is the base condition code or the inverse of the base condition code. It contains 0b00000 when no IT block is active.

When an IT instruction is executed, these bits are set according to the condition in the instruction, and the *Then* and *Else* (T and E) parameters in the instruction (see *IT* on page A5-92 for details).

During execution of an IT block, IT<4:0> is shifted:

- to reduce the number of instructions to be conditionally executed by one
- to move the next bit into position to form the least significant bit of the condition code.

See Table A4-37 for the way the shift operates.

Table A4-37 Shifting of IT execution state bits

Old state						New state					
IT[7:5]	IT[4]	IT[3]	IT[2]	IT[1]	IT[0]	IT[7:5]	IT[4]	IT[3]	IT[2]	IT[1]	IT[0]
cond_base	P1	P2	P3	P4	1	cond_base	P2	P3	P4	1	0
cond_base	P1	P2	P3	1	0	cond_base	P2	P3	1	0	0
cond_base	P1	P2	1	0	0	cond_base	P2	1	0	0	0
cond_base	P1	1	0	0	0	0b000	0	0	0	0	0

See Table A4-38 for the effect of each state.

Table A4-38 Effect of IT execution state bits

Entry point for:	IT[7:5]	IT[4]	IT[3]	IT[2]	IT[1]	IT[0]	
4-instruction IT block	cond_base	P1	P2	P3	P4	1	Next instruction has condition cond_base, P1
3-instruction IT block	cond_base	P1	P2	P3	1	0	Next instruction has condition cond_base, P1
2-instruction IT block	cond_base	P1	P2	1	0	0	Next instruction has condition cond_base, P1
1-instruction IT block	cond_base	P1	1	0	0	0	Next instruction has condition cond_base, P1
	0b000	0	0	0	0	0	Normal execution (not in an IT block)
	non-zero	0	0	0	0	0	UNPREDICTABLE
	0bxxx	1	0	0	0	0	UNPREDICTABLE

A4.5 UNDEFINED and UNPREDICTABLE instruction set space

An attempt to execute an unallocated instruction results in either:

- Unpredictable behavior. The instruction is described as UNPREDICTABLE.
- An Undefined Instruction exception. The instruction is described as UNDEFINED.

This section describes the general rules that determine whether an unallocated instruction in the Thumb instruction set space is UNDEFINED or UNPREDICTABLE.

Note

See *Usage of 0b1111 as a register specifier* on page A4-39 and *Usage of 0b1101 as a register specifier* on page A4-41 for additional information on UNPREDICTABLE behavior.

A4.5.1 16-bit instruction set space

Instruction bits<15:6> are used for decode.

Instructions where bits<15:10> == 0b010001 are *special data processing* operations. Unallocated instructions in this space are UNPREDICTABLE. In ARMv6 this is where bits<9:6> == 0b0000 or 0b0100. In ARMv7 this is where bits<9:6> == 0b0100.

All other unallocated instructions are UNDEFINED.

Permanently undefined space

The part of the instruction set space where bits<15:8> == 0b11011110 is architecturally undefined. This space is available for instruction emulation, or for other purposes where software wants to force an Undefined Instruction exception to occur.

A4.5.2 32-bit instruction set space

The following general rules apply to all 32-bit Thumb instructions:

- The hw1<15:11> bit-field is always in the range 0b11101 to 0b11111 inclusive.
- Instruction classes are determined by hw1<15:8,6> and hw2<15>. For details see Figure A4-3 on page A4-12.
- Instructions are made up of three types of bit field:
 - opcode fields
 - register specifiers
 - immediate fields specifying shifts or immediate values.
- Opcode fields are defined in Figure A4-4 on page A4-13 to Figure A4-10 on page A4-32 inclusive.

An instruction is UNDEFINED if:

- it corresponds to any Undefined or Reserved encoding in Figure A4-4 on page A4-13 to Figure A4-10 on page A4-32 inclusive
- it corresponds to an opcode bit pattern that is missing from the tables associated with the figures (that is, Table A4-21 on page A4-14 to Table A4-35 on page A4-31 inclusive), or noted in the subsection text
- it is declared as UNDEFINED within an instruction description.

An instruction is UNPREDICTABLE if:

- a register specifier is 0b1111 or 0b1101 and the instruction does not specifically describe this case
- an SBZ bit or multi-bit field is not zero or all zeros
- an SBO bit or multi-bit field is not one or all ones
- it is declared as UNPREDICTABLE within an instruction description.

A4.6 Usage of 0b1111 as a register specifier

When a value of 0b1111 is permitted as a register specifier in Thumb-2, a variety of meanings is possible. For register reads, these meanings are:

- Read the PC value, that is, the address of the current instruction + 4. The base register of the table branch instructions `TBB` and `TBH` is allowed to be the PC. This allows branch tables to be placed in memory immediately after the instruction. (Some instructions read the PC value implicitly, without the use of a register specifier, for example the conditional branch instruction `B<cond>`.)

———— **Note** —————

Use of the PC as the base register in the `STC` instruction is deprecated in ARMv7.

- Read the word-aligned PC value, that is, the address of the current instruction + 4, with bits<1:0> forced to zero. The base register of `LDC`, `STC`, `LDR`, `LDRB`, `LDRD` (pre-indexed, no writeback), `LDRH`, `LDRSB`, and `LDRSH` instructions are allowed to be the word-aligned PC. This allows PC-relative data addressing. In addition, the `ADDW` and `SUBW` instructions allow their source registers to be 0b1111 for the same purpose.
- Read zero. Where this occurs, the instruction can be a special case of another, more general instruction, but with one operand zero. In these cases, the instructions are listed on separate pages. This is the case for the following instructions:

<code>BFC</code>	special case of <code>BFI</code>
<code>MOV</code>	special case of <code>ORR</code>
<code>MUL</code>	special case of <code>MLA</code>
<code>MVN</code>	special case of <code>ORN</code>

For register writes, these meanings are:

- The PC can be specified as the destination register of an `LDR` instruction. This is done by encoding `Rt` as 0b1111. The loaded value is treated as an address, and the effect of execution is a branch to that address. Bit<0> of the loaded value determines the instruction execution state and must be 1.

Some other instructions write the PC in similar ways, either implicitly (for example, `B<cond>`) or by using a register mask rather than a register specifier (`LDM`). The address to branch to can be a loaded value (for example, `LDM`), a register value (for example, `BX`), or the result of a calculation (for example, `TBB` or `TBH`).

- Discard the result of a calculation. This is done when one instruction is a special case of another, more general instruction, but with the result discarded. In these cases, the instructions are listed on separate pages, with Encoding notes for each instruction cross-referencing the other.

This is the case for the following instructions:

<code>CMN</code>	special case of <code>ADDS</code>
<code>CMP</code>	special case of <code>SUBS</code>
<code>TEQ</code>	special case of <code>EORS</code>
<code>TST</code>	special case of <code>ANDS</code> .

- If the destination register specifier of an LDRB, LDRH, LDRSB, or LDRSH instruction is 0b1111, the instruction is a memory hint instead of a load operation.

This is the case for the following instructions:

PLD uses LDRB encoding

PLI uses LDRSB encoding.

The unallocated memory hint instruction encodings (LDRH and LDRSH encodings) execute as NOP, instead of being UNDEFINED or UNPREDICTABLE like most other unallocated instruction encodings. See *Memory hints* on page A5-14 for further details.

- If the destination register specifier of an MRC instruction is 0b1111, bits<31:28> of the value transferred from the coprocessor are written to the (N,Z,C,V) flags in the APSR, and bits<27:0> are discarded.

A4.6.1 M profile interworking support

Thumb interworking uses bit<0> on some writes to the PC to determine the instruction execution state. ARMv7-M only supports the Thumb instruction execution state, therefore the value must be 1 in interworking instructions, otherwise a fault occurs. For 16-bit instructions, interworking behavior is as follows:

- ADD (register) and MOV (register) branch within Thumb state ignoring bit<0>.
- B, or the B instruction, branches without interworking
- BKPT and SVC cause exceptions, the exception mechanism responsible for any state transition. They are not considered to be interworking instructions.
- BLX (register) and BX interwork on the value in Rm

For 32-bit instructions, interworking behavior is as follows:

- B, or the B instruction, branches without interworking
- BL branches to Thumb state based on the instruction encoding, not due to bit<0> of the value written to the PC.
- LDM and LDR support interworking using the value written to the PC.
- TBB and TBH branch without interworking.

A4.7 Usage of 0b1101 as a register specifier

R13 is defined in Thumb-2 such that its usage model is required to be that of a stack pointer, aligning R13 with the *ARM Architecture Procedure Call Standard (AAPCS)*, the architecture usage model supported by the PUSH and POP instructions in the 16-bit instruction set.

In the 32-bit Thumb instruction set, if R13 is used as a general purpose register beyond the architecturally defined constraints described in this section, the results are UNPREDICTABLE.

A4.7.1 R13<1:0> definition

For bits<1:0> of R13, software must adopt a *SBZP* (Should Be Zero or Preserved) write policy, that is, it is permitted to write zeros or values read from them. Writing anything else to bits<1:0> results in UNPREDICTABLE values. Reading bits<1:0> returns the value written earlier, unless the value read is UNPREDICTABLE.

This definition means that R13 can be set to a word-aligned address. This supports ADD/SUB R13, R13, #4 without either a requirement that R13<1:0> must always read as zero or a need to use ADD/SUB Rt, R13, #4; BIC R13, Rt, #3 to force word-alignment of the write to R13.

A4.7.2 Thumb-2 ISA support for R13

R13 instruction support is restricted to the following:

- R13 as the source or destination register of a MOV instruction. Only register <=> register (no shift) transfers are supported, with no flag setting:

```
MOV    SP, Rm
MOV    Rn, SP
```
- Adjusting R13 up or down by a multiple of its alignment:

```
ADD{W} SP, SP, #N          ; For N a multiple of 4
SUB{W} SP, SP, #N          ; For N a multiple of 4
ADD    SP, SP, Rm, LSL #shft ; For shft=0,1,2,3
SUB    SP, SP, Rm, LSL #shft ; For shft=0,1,2,3
```
- R13 as a base register <Rn> of any load or store instruction. This supports SP-based addressing for load, store, or memory hint instructions, with positive or negative offsets, with and without writeback.
- R13 as the first operand <Rn> in any ADD{S}, ADDW, CMN, CMP, SUB{S}, or SUBW instruction. The add/subtract instructions support SP-based address generation, with the address going into a general-purpose register. CMN and CMP are useful for stack checking in some circumstances.
- R13 as the transferred register <Rt> in any LDR or STR instruction.

A4.7.3 Thumb-2 16-bit ISA support for R13

For 16-bit data processing instructions that affect registers other than R0-R7 (the high registers), R13 can only be used as described in *Thumb-2 ISA support for R13* on page A4-41. Any other use is deprecated. This affects the high register form of CMP, where the use of R13 as <Rm> is deprecated.

Chapter A5

Thumb Instructions

This chapter describes Thumb® instruction support in ARMv7-M. It contains the following sections:

- *Format of instruction descriptions* on page A5-2
- *Immediate constants* on page A5-8
- *Constant shifts applied to a register* on page A5-10
- *Memory accesses* on page A5-13
- *Memory hints* on page A5-14
- *Alphabetical list of Thumb instructions* on page A5-16.

A5.1 Format of instruction descriptions

The instruction descriptions in the alphabetical lists of instructions in *Alphabetical list of Thumb instructions* on page A5-16 normally use the following format:

- instruction section title
- introduction to the instruction
- instruction encoding(s)
- architecture version information
- assembler syntax
- pseudo-code describing how the instruction operates
- exception information
- notes (where applicable).

Each of these items is described in more detail in the following subsections.

A few instruction descriptions describe alternative mnemonics for other instructions and use an abbreviated and modified version of this format.

A5.1.1 Instruction section title

The instruction section title gives the base mnemonic for the instructions described in the section. When one mnemonic has multiple forms described in separate instruction sections, this is followed by a short description of the form in parentheses. The most common use of this is to distinguish between forms of an instruction in which one of the operands is an immediate value and forms in which it is a register.

Parenthesized text is also used to document the former mnemonic in some cases where a mnemonic has been replaced entirely by another mnemonic in the assembler syntax.

A5.1.2 Introduction to the instruction

The instruction section title is followed by text that briefly describes the main features of the instruction. This description is not necessarily complete and is not definitive. If there is any conflict between it and the more detailed information that follows, the latter takes priority.

A5.1.3 Instruction encodings

The *Encodings* subsection contains a list of one or more instruction encodings. For reference purposes, each Thumb instruction encoding is labelled, T1, T2, T3...

Each instruction encoding description consists of:

- An assembly syntax that ensures that the assembler selects the encoding in preference to any other encoding. In some cases, multiple syntaxes are given. The correct one to use is sometimes indicated by annotations to the syntax, such as *Inside IT block* and *Outside IT block*. In other cases, the correct one to use can be determined by looking at the assembler syntax description and using it to determine which syntax corresponds to the instruction being disassembled.

There is usually more than one syntax that ensures re-assembly to any particular encoding, and the exact set of syntaxes that do so usually depends on the register numbers, immediate constants and other operands to the instruction. For example, when assembling to the Thumb instruction set, the syntax `AND R0, R0, R8` ensures selection of a 32-bit encoding but `AND R0, R0, R1` selects a 16-bit encoding.

The assembly syntax documented for the encoding is chosen to be the simplest one that ensures selection of that encoding for all operand combinations supported by that encoding. This often means that it includes elements that are only necessary for a small subset of operand combinations. For example, the assembler syntax documented for the 32-bit Thumb `AND` (register) encoding includes the `.W` qualifier to ensure that the 32-bit encoding is selected even for the small proportion of operand combinations for which the 16-bit encoding is also available.

The assembly syntax given for an encoding is therefore a suitable one for a disassembler to disassemble that encoding to. However, disassemblers may wish to use simpler syntaxes when they are suitable for the operand combination, in order to produce more readable disassembled code.

- An encoding diagram. This is half-width for 16-bit Thumb encodings and full-width for 32-bit Thumb encodings. The 32-bit Thumb encodings use a double vertical line between the two halfwords to act as a reminder that 32-bit Thumb encodings use the byte order of a sequence of two halfwords rather than of a word, as described in *Instruction alignment and byte ordering* on page A3-6.
- Encoding-specific pseudo-code. This is pseudo-code that translates the encoding-specific instruction fields into inputs to the encoding-independent pseudo-code in the later *Operation* subsection, and that picks out any special cases in the encoding. For a detailed description of the pseudo-code used and of the relationship between the encoding diagram, the encoding-specific pseudo-code and the encoding-independent pseudo-code, see Appendix A *Pseudo-code definition*.

A5.1.4 Architecture version information

The *Architecture versions* subsection contains information about which architecture versions include the instruction. This often differs between encodings.

A5.1.5 Assembler syntax

The *Assembly syntax* subsection describes the standard UAL syntax for the instruction.

Each syntax description consists of the following elements:

- One or more syntax prototype lines written in a typewriter font, using the conventions described in *Assembler syntax prototype line conventions*. Each prototype line documents the mnemonic and (where appropriate) operand parts of a full line of assembler code. When there is more than one such line, each prototype line is annotated to indicate required results of the encoding-specific pseudo-code. For each instruction encoding, this information can be used to determine whether any instructions matching that encoding are available when assembling that syntax, and if so, which ones.
- The line *where*: followed by descriptions of all of the variable or optional fields of the prototype syntax line.

Some syntax fields are standardized across all or most instructions. These fields are described in *Standard assembler syntax fields* on page A5-6.

By default, syntax fields that specify registers (such as <Rd>, <Rn>, or <Rt>) are permitted to be any of R0-R12 or LR in Thumb instructions. These require that the encoding-specific pseudo-code should set the corresponding integer variable (such as *d*, *n*, or *t*) to the corresponding register number (0-12 for R0-R12, 14 for LR). This can normally be done by setting the corresponding bitfield in the instruction (named *Rd*, *Rn*, *Rt*...) to the binary encoding of that number. In the case of 16-bit Thumb encodings, this bitfield is normally of length 3 and so the encoding is only available when one of R0-R7 was specified in the assembler syntax. It is also common for such encodings to use a bitfield name such as *Rdn*. This indicates that the encoding is only available if <Rd> and <Rn> specify the same register, and that the register number of that register is encoded in the bitfield if they do.

The description of a syntax field that specifies a register sometimes extends or restricts the permitted range of registers or document other differences from the default rules for such fields. Typical extensions are to allow the use of the SP and/or the PC (using register numbers 13 and 15 respectively).

Note

The pre-UAL Thumb assembler syntax is incompatible with UAL and is not documented in the instruction sections.

Assembler syntax prototype line conventions

The following conventions are used in assembler syntax prototype lines and their subfields:

- < > Any item bracketed by < and > is a short description of a type of value to be supplied by the user in that position. A longer description of the item is normally supplied by subsequent text. Such items often correspond to a similarly named field in an encoding diagram for an instruction. When the correspondence simply requires the binary encoding of an integer value or register number to be substituted into the instruction encoding, it is not described explicitly. For example, if the assembler syntax for a Thumb instruction contains an item <Rn> and the instruction encoding diagram contains a 4-bit field named *Rn*, the number of the register specified in the assembler syntax is encoded in binary in the instruction field.

If the correspondence between the assembler syntax item and the instruction encoding is more complex than simple binary encoding of an integer or register number, the item description or the encoding pseudocode indicates how it is encoded.

- { }
 - |
 - spaces**
 - + / -
 - *
- Any item bracketed by { and } is optional. A description of the item and of how its presence or absence is encoded in the instruction is normally supplied by subsequent text.
- This indicates an alternative character string. For example, LDM|STM is either LDM or STM.
- Single spaces are used for clarity, to separate items. When a space is obligatory in the assembler syntax, two or more consecutive spaces are used.
- This indicates an optional + or - sign. If neither is coded, + is assumed.
- When used in a combination like <immed_8> * 4, this describes an immediate value which must be a specified multiple of a value taken from a numeric range. In this instance, the numeric range is 0 to 255 (the set of values that can be represented as an 8-bit immediate) and the specified multiple is 4, so the value described must be a multiple of 4 in the range $4*0 = 0$ to $4*255 = 1020$.

All other characters must be encoded precisely as they appear in the assembler syntax. Apart from { and }, the special characters described above do not appear in the basic forms of assembler instructions documented in this manual. The { and } characters need to be encoded in a few places as part of a variable item. When this happens, the description of the variable item indicates how they must be used.

Standard assembler syntax fields

The following assembler syntax fields are standard across all or most instructions:

<c> Is an optional field. It specifies the condition under which the instruction is executed. If <c> is omitted, it defaults to *always* (AL). For details see *Conditional execution* on page A4-33.

<q> Specifies optional assembler qualifiers on the instruction. The following qualifiers are defined:

.N Meaning narrow, specifies that the assembler must select a 16-bit encoding for the instruction. If this is not possible, an assembler error is produced.

.W Meaning wide, specifies that the assembler must select a 32-bit encoding for the instruction. If this is not possible, an assembler error is produced.

If neither .W nor .N is specified, the assembler can select either 16-bit or 32-bit encodings. If both are available, it must select a 16-bit encoding. In a few cases, more than one encoding of the same length can be available for an instruction. The rules for selecting between such encodings are instruction-specific and are part of the instruction description.

A5.1.6 Pseudo-code describing how the instruction operates

The *Operation* subsection contains encoding-independent pseudo-code that describes the main operation of the instruction. For a detailed description of the pseudo-code used and of the relationship between the encoding diagram, the encoding-specific pseudo-code and the encoding-independent pseudo-code, see Appendix A *Pseudo-code definition*.

A5.1.7 Exception information

The *Exceptions* subsection contains a list of the exceptional conditions that can be caused by execution of the instruction.

Processor exceptions are listed as follows:

- Resets and interrupts (including NMI, PendSV and SysTick) are not listed. They can occur before or after the execution of any instruction, and in some cases during the execution of an instruction, but they are not in general caused by the instruction concerned.
- MemManage and BusFault exceptions are listed for all instructions that perform explicit data memory accesses.
All instruction fetches can cause MemManage and BusFault exceptions. These are not caused by execution of the instruction and so are not listed.
- UsageFault exceptions can occur for a variety of reasons and are listed against instructions as appropriate.
UsageFault exceptions also occur when pseudocode indicates that the instruction is UNDEFINED. These UsageFaults are not listed.
- The SVCcall exception is listed for the SVC instruction.
- The DebugMonitor exception is listed for the BKPT instruction.
- HardFault exceptions can arise from escalation of faults listed against an instruction, but are not themselves listed.

Note

For a summary of the different types of MemManage, BusFault and UsageFault exceptions see *Fault behavior* on page B1-14.

A5.1.8 Notes

Where appropriate, additional notes about the instruction appear under further subheadings.

A5.2 Immediate constants

This section applies to those 32-bit data processing instruction encodings that use the `ThumbExpandImm()` or `ThumbExpandImmWithC()` functions in their pseudocode to generate an immediate value from 12 instruction bits.

The following classes of constant are available in Thumb-2:

- Any constant that can be produced by shifting an 8-bit value left by any number of bits. See *Shifted 8-bit values* for details of the encoding.
- Any replicated halfword constant of the form `0x00XY00XY`. See *Constants of the form 0x00XY00XY* for details of the encoding.
- Any replicated halfword constant of the form `0xXY00XY00`. See *Constants of the form 0xXY00XY00* for details of the encoding.
- Any replicated byte constant of the form `0xXYXYXYXY`. See *Constants of the form 0xXYXYXYXY* on page A5-9 for details of the encoding.

A5.2.1 Encoding

The assembler encodes the constant in an instruction into `imm12`, as described below. `imm12` is mapped into the instruction encoding in `hw1[10]` and `hw2[14:12,7:0]`, in the same order.

Shifted 8-bit values

If the constant lies in the range 0-255, then `imm12` is the unmodified constant.

Otherwise, the 32-bit constant is rotated left until the most significant bit is bit[7]. The size of the left rotation is encoded in `bits[11:7]`, overwriting bit[7]. `imm12` is `bits[11:0]` of the result.

For example, the constant `0x01100000` has its most significant bit at bit position 24. To rotate this bit to bit[7], a left rotation by 15 bits is required. The result of the rotation is `0b10001000`. The 12-bit encoding of the constant consists of the 5-bit encoding of the rotation amount 15 followed by the bottom 7 bits of this result, and so is `0b011110001000`.

Constants of the form 0x00XY00XY

Bits[11:8] of `imm12` are set to `0b0001`, and bits[7:0] are set to `0xXY`.

This form is UNPREDICTABLE if `bits[7:0] == 0x00`.

Constants of the form 0xXY00XY00

Bits[11:8] of `imm12` are set to `0b0010`, and bits[7:0] are set to `0xXY`.

This form is UNPREDICTABLE if `bits[7:0] == 0x00`.

Constants of the form 0xXYXYXYXY

Bits[11:8] of imm12 are set to 0b0011, and bits[7:0] are set to 0xXY.

This form is UNPREDICTABLE if bits[7:0] == 0x00.

A5.2.2 Operation

```
// ThumbExpandImm()
// -----

bits(32) ThumbExpandImm(bits(12) imm12)
(imm32, -) = ThumbExpandImmWithC(imm12);
return imm12;

// ThumbExpandImmWithC()
// -----

(bits(32), bit) ThumbExpandImmWithC(bits(12) imm12)

if imm12<11:10> == '00' then

    case imm12<9:8> of
        when '00'
            imm32 = ZeroExtend(imm12<7:0>, 32);
        when '01'
            if imm12<7:0> == '00000000' then UNPREDICTABLE;
            imm32 = '00000000' : imm12<7:0> : '00000000' : imm12<7:0>;
        when '10'
            if imm12<7:0> == '00000000' then UNPREDICTABLE;
            imm32 = imm12<7:0> : '00000000' : imm12<7:0> : '00000000';
        when '11'
            if imm12<7:0> == '00000000' then UNPREDICTABLE;
            imm32 = imm12<7:0> : imm12<7:0> : imm12<7:0> : imm12<7:0>;

    carry_out = APSR.C;

else

    unrotated_value = ZeroExtend('1':imm12<6:0>, 32);
    (imm32, carry_out) = ROR_C(unrotated_value, UInt(imm12<11:7>));

return (imm32, carry_out);
```

A5.3 Constant shifts applied to a register

`<shift>` is an optional shift to be applied to `<Rm>`. It can be any one of:

(omitted) Equivalent to `LSL #0`.

`LSL #n`
logical shift left n bits. $0 \leq n \leq 31$.

`LSR #n`
logical shift right n bits. $1 \leq n \leq 32$.

`ASR #n`
arithmetic shift right n bits. $1 \leq n \leq 32$.

`ROR #n`
rotate right n bits. $1 \leq n \leq 31$.

`RRX` rotate right one bit, with extend. Bit[0] is written to `shifter_carry_out`, bits[31:1] are shifted right one bit, and the Carry Flag is shifted into bit[31].

A5.3.1 Encoding

The assembler encodes `<shift>` into two type bits and five immediate bits, as follows:

(omitted) type = 0b00, immediate = 0.

`LSL #n`
type = 0b00, immediate = n .

`LSR #n`
type = 0b01.
If $n < 32$, immediate = n .
If $n == 32$, immediate = 0.

`ASR #n`
type = 0b10.
If $n < 32$, immediate = n .
If $n == 32$, immediate = 0.

`ROR #n`
type = 0b11, immediate = n .

`RRX` type = 0b11, immediate = 0.

A5.3.2 Shift operations

```

enumeration SRType (SRType_None, SRType_LSL, SRType_LSR,
                    SRType_ASR, SRType_ROR, SRType_RRX);

// DecodeImmShift()
// -----

(SRType, integer) DecodeImmShift(bits(2) type, bits(5) imm5)

case type of

    when '00'
        shift_t = SRType_LSL;
        shift_n = UInt(imm5);

    when '01'
        shift_t = SRType_LSR;
        shift_n = if imm5 == '00000' then 32 else UInt(imm5);

    when '10'
        shift_t = SRType_ASR;
        shift_n = if imm5 == '00000' then 32 else UInt(imm5);

    when '11'
        if imm5 == '00000' then
            shift_t = SRType_RRX;
            shift_n = 1;
        else
            shift_t = SRType_ROR;
            shift_n = UInt(imm5);

return (shift_t, shift_n);

// DecodeRegShift()
// -----

SRType DecodeRegShift(bits(2) type)
case type of
    when '00'
        shift_t = SRType_LSL;
    when '01'
        shift_t = SRType_LSR;
    when '10'
        shift_t = SRType_ASR;
    when '11'
        shift_t = SRType_ROR;
return shift_t;

// Shift()
// -----

```

```
bits(N) Shift(bits(N) value, SRType type, integer n, bit carry_in)
(result, -) = Shift_C(value, type, n, carry_in);
return result;

// Shift_C()
// -----

(bits(N), bit) Shift_C(bits(N) value, SRType type, integer n, bit carry_in)
case type of
    when SRType_None // Identical to SRType_LSL with n == 0
        (result, carry_out) = (value, carry_in);

    when SRType_LSL
        if n == 0 then
            (result, carry_out) = (value, carry_in);
        else
            (result, carry_out) = LSL_C(value, n);

    when SRType_LSR
        (result, carry_out) = LSR_C(value, n);

    when SRType_ASR
        (result, carry_out) = ASR_C(value, n);

    when SRType_ROR
        (result, carry_out) = ROR_C(value, n);

    when SRType_RRX
        (result, carry_out) = RRX_C(value, carry_in);

return (result, carry_out);
```

A5.4 Memory accesses

Memory access instructions can use any of three addressing modes:

Offset addressing

The offset value is added to or subtracted from an address obtained from the base register. The result is used as the address for the memory access. The base register is unaltered.

The assembly language syntax for this mode is:

```
[<Rn>, <offset>]
```

Pre-indexed addressing

The offset value is added to or subtracted from an address obtained from the base register. The result is used as the address for the memory access, and written back into the base register.

The assembly language syntax for this mode is:

```
[<Rn>, <offset>]!
```

Post-indexed addressing

The address obtained from the base register is used, unaltered, as the address for the memory access. The offset value is added to or subtracted from the address, and written back into the base register.

The assembly language syntax for this mode is:

```
[<Rn>], <offset>
```

In each case, <Rn> is the base register. <offset> can be:

- an immediate constant, such as <imm8> or <imm12>
- an index register, <Rm>
- a shifted index register, such as <Rm>, LSL #<shift>.

For information about unaligned access, endianness, and exclusive access, see:

- *Alignment Support* on page A3-3
- *Endian Support* on page A3-5
- *Synchronization and semaphores* on page A3-8

A5.4.1 Memory stores and exclusive access

The Operation sections of instruction definitions, other than the exclusive stores, do not include pseudo-code describing exclusive access support in multiprocessor systems with shared memory. If your system has shared memory, all memory writes include the operations described by the following pseudo-code:

```
If (Shared(address)) then
    ClearExclusiveByAddress(physical_address, <size>)
```

For more information about exclusive access support, see *Synchronization and semaphores* on page A3-8.

A5.5 Memory hints

Some load instructions with $Rt == 0b1111$ are memory *hints*. Memory hints allow you to provide advance information to memory systems about future memory accesses, without actually loading or storing any data.

PLD and PLI are the only memory hint instructions currently provided. For details, see:

- *PLD (immediate)* on page A5-198
- *PLD (register)* on page A5-200
- *PLI (immediate)* on page A5-202
- *PLI (register)* on page A5-204.

Other memory hints are currently unallocated. Unallocated memory hints must be implemented as NOP, and software must not use them.

See also *Load and store single data item, and memory hints* on page 3-26 and *Usage of 0b1111 as a register specifier in 32-bit encodings* on page 3-38>.

A5.6 NOP-compatible hints

Hint instructions which are not associated with memory accesses are part of a separate category of hint instructions known as NOP-compatible hints. NOP-compatible hints provide IMPLEMENTATION DEFINED behavior or act as a NOP. Both 16-bit and 32-bit encodings have been reserved:

- For information on the 16-bit encodings see *Miscellaneous instructions* on page A4-9, specifically Figure A4-2 on page A4-9 and *NOP-compatible hint instructions* on page A4-11.
- For information on the 32-bit encodings see *Branches, miscellaneous control instructions* on page A4-30, specifically Figure A4-9 on page A4-30 and *NOP-compatible hint instructions* on page A4-31.

A5.7 Alphabetical list of Thumb instructions

Every Thumb instruction is listed in this section. See *Format of instruction descriptions* on page A5-2 for details of the format used.

Assembler syntax

```
ADC{S}<c><q> {<Rd>, } <Rn>, #<const>
```

where:

- S If present, specifies that the instruction updates the flags. Otherwise, the instruction does not update the flags.
- <c><q> See *Standard assembler syntax fields* on page A5-6.
- <Rd> Specifies the destination register. If <Rd> is omitted, this register is the same as <Rn>.
- <Rn> Specifies the register that contains the first operand.
- <const> Specifies the immediate value to be added to the value obtained from <Rn>. See *Immediate constants* on page A5-8 for the range of allowed values.

The pre-UAL syntax ADC<c>S is equivalent to ADCS<c>.

Operation

```
if ConditionPassed() then
    EncodingSpecificOperations();
    (result, carry, overflow) = AddWithCarry(R[n], imm32, APSR.C);
    R[d] = result;
    if setflags then
        APSR.N = result<31>;
        APSR.Z = IsZeroBit(result);
        APSR.C = carry;
        APSR.V = overflow;
```

Exceptions

None.

A5.7.2 ADC (register)

Add with Carry (register) adds a register value, the carry flag value, and an optionally-shifted register value, and writes the result to the destination register. It can optionally update the condition flags based on the result.

Encodings

T1 ADCS <Rdn>, <Rm> Outside IT block.
 ADC<c> <Rdn>, <Rm> Inside IT block.

15	14	13	12	11	10	9	8	7	6	5	4	3	2	1	0
0 1 0 0 0 0						0 1 0 1				Rm		Rdn			

```
d = UInt(Rdn); n = UInt(Rdn); m = UInt(Rm); setflags = !InITBlock();
(shift_t, shift_n) = (SType_None, 0);
```

T2 ADC{S}<c>.W <Rd>, <Rn>, <Rm>{, <shift>}

15	14	13	12	11	10	9	8	7	6	5	4	3	2	1	0	15	14	13	12	11	10	9	8	7	6	5	4	3	2	1	0
1 1 1 0 1						0 1		1 0 1 0				S	Rn				(0)		imm3			Rd			imm2		type		Rm		

```
d = UInt(Rd); n = UInt(Rn); m = UInt(Rm); setflags = (S == '1');
(shift_t, shift_n) = DecodeImmShift(type, imm3:imm2);
if BadReg(d) || BadReg(n) || BadReg(m) THEN UNPREDICTABLE;
```

Architecture versions

Encoding T1 All versions of the Thumb instruction set

Encoding T2 All versions of the Thumb instruction set from Thumb-2 onwards.

Assembler syntax

```
ADC{S}<c><q> {<Rd>, } <Rn>, <Rm> {, <shift>}
```

where:

S	If present, specifies that the instruction updates the flags. Otherwise, the instruction does not update the flags.
<c><q>	See <i>Standard assembler syntax fields</i> on page A5-6.
<Rd>	Specifies the destination register. If <Rd> is omitted, this register is the same as <Rn>.
<Rn>	Specifies the register that contains the first operand.
<Rm>	Specifies the register that is optionally shifted and used as the second operand.
<shift>	Specifies the shift to apply to the value read from <Rm>. If <shift> is omitted, no shift is applied and both encodings are permitted. If <shift> is specified, only encoding T2 is permitted. The possible shifts and how they are encoded are described in <i>Constant shifts applied to a register</i> on page A5-10.

A special case is that if ADC<c> <Rd>, <Rn>, <Rd> is written with <Rd> and <Rn> both in the range R0-R7, it will be assembled using encoding T2 as though ADC<c> <Rd>, <Rn> had been written. To prevent this happening, use the .W qualifier.

The pre-UAL syntax ADC<c>S is equivalent to ADCS<c>.

Operation

```
if ConditionPassed() then
    EncodingSpecificOperations();
    shifted = Shift(R[m], shift_t, shift_n, APSR.C);
    (result, carry, overflow) = AddWithCarry(R[n], shifted, APSR.C);
    R[d] = result;
    if setflags then
        APSR.N = result<31>;
        APSR.Z = IsZeroBit(result);
        APSR.C = carry;
        APSR.V = overflow;
```

Exceptions

None.

```

d = UInt(Rd);  n = UInt(Rn);  setflags = FALSE;
imm32 = ZeroExtend(i:imm3:imm8, 32);
if n == 15 then SEE ADR on page A5-30;
if n == 13 then SEE ADD (SP plus immediate) on page A5-26;
if BadReg(d) then UNPREDICTABLE;

```

Architecture versions

Encodings T1, T2 All versions of the Thumb instruction set.

Encodings T3, T4 All versions of the Thumb instruction set from Thumb-2 onwards.

Assembler syntax

```

ADD{S}<c><q>  {<Rd>,<Rn>,<#const>}           All encodings permitted
ADDW<c><q>  {<Rd>,<Rn>,<#const>}           Only encoding T4 permitted

```

where:

- S** If present, specifies that the instruction updates the flags. Otherwise, the instruction does not update the flags.
- <c><q>** See *Standard assembler syntax fields* on page A5-6.
- <Rd>** Specifies the destination register. If <Rd> is omitted, this register is the same as <Rn>.
- <Rn>** Specifies the register that contains the first operand. If the SP is specified for <Rn>, see *ADD (SP plus immediate)* on page A5-26. If the PC is specified for <Rn>, see *ADR* on page A5-30.
- <const>** Specifies the immediate value to be added to the value obtained from <Rn>. The range of allowed values is 0-7 for encoding T1, 0-255 for encoding T2 and 0-4095 for encoding T4. See *Immediate constants* on page A5-8 for the range of allowed values for encoding T3.
When multiple encodings of the same length are available for an instruction, encoding T3 is preferred to encoding T4 (if encoding T4 is required, use the ADDW syntax). Encoding T1 is preferred to encoding T2 if <Rd> is specified and encoding T2 is preferred to encoding T1 if <Rd> is omitted.

The pre-UAL syntax ADD<c>S is equivalent to ADDS<c>.

Operation

```

if ConditionPassed() then
    EncodingSpecificOperations();
    (result, carry, overflow) = AddWithCarry(R[n], imm32, '0');
    R[d] = result;
    if setflags then
        APSR.N = result<31>;

```

```
APSR.Z = IsZeroBit(result);  
APSR.C = carry;  
APSR.V = overflow;
```

Exceptions

None.

A5.7.4 ADD (register)

This instruction adds a register value and an optionally-shifted register value, and writes the result to the destination register. It can optionally update the condition flags based on the result.

Encodings

T1 ADDS <Rd>, <Rn>, <Rm> Outside IT block.
 ADD<c> <Rd>, <Rn>, <Rm> Inside IT block.

15	14	13	12	11	10	9	8	7	6	5	4	3	2	1	0
0	0	0	1	1	0	0	Rm		Rn		Rd				

```
d = UInt(Rd); n = UInt(Rn); m = UInt(Rm); setflags = !InITBlock();
(shift_t, shift_n) = (SRType_None, 0);
```

T2 ADD<c> <Rdn>, <Rm>

15	14	13	12	11	10	9	8	7	6	5	4	3	2	1	0
0	1	0	0	0	1	0	0	DN	Rm		Rdn				

```
d = UInt(DN:Rdn); n = UInt(DN:Rdn); m = UInt(Rm); setflags = FALSE;
(shift_t, shift_n) = (SRType_None, 0);
if d == 13 || m == 13 then SEE ADD (SP plus register) on page A5-28;
```

T3 ADD{S}<c>.W <Rd>, <Rn>, <Rm>{, <shift>}

15	14	13	12	11	10	9	8	7	6	5	4	3	2	1	0	15	14	13	12	11	10	9	8	7	6	5	4	3	2	1	0
1	1	1	0	1	0	1	1	0	0	0	S	Rn		(0)	imm3	Rd	imm2	type	Rm												

```
d = UInt(Rd); n = UInt(Rn); m = UInt(Rm); setflags = (S == '1');
(shift_t, shift_n) = DecodeImmShift(type, imm3:imm2);
if d == 15 && setflags then SEE CMN (register) on page A5-71;
if n == 13 then SEE ADD (SP plus register) on page A5-28;
if BadReg(d) || n == 15 || BadReg(m) then UNPREDICTABLE;
```

Architecture versions

Encodings T1, T2 All versions of the Thumb instruction set. Before Thumb-2, encoding T2 required that either <Rdn>, or <Rm>, or both, had to be from {R8-R12, LR, PC}.

Encoding T3 All versions of the Thumb instruction set from Thumb-2 onwards.

Assembler syntax

```
ADD{S}<c><q> {<Rd>}, <Rn>, <Rm> {,<shift>}
```

where:

- S** If present, specifies that the instruction updates the flags. Otherwise, the instruction does not update the flags.
- <c><q>** See *Standard assembler syntax fields* on page A5-6.
- <Rd>** Specifies the destination register. If <Rd> is omitted, this register is the same as <Rn> and encoding T2 is preferred to encoding T1 if both are available (this can only happen inside an IT block). If <Rd> is specified, encoding T1 is preferred to encoding T2.
- <Rn>** Specifies the register that contains the first operand. If the SP is specified for <Rn>, see *ADD (SP plus register)* on page A5-28.
- <Rm>** Specifies the register that is optionally shifted and used as the second operand.
- <shift>** Specifies the shift to apply to the value read from <Rm>. If <shift> is omitted, no shift is applied and all encodings are permitted. If <shift> is specified, only encoding T3 is permitted. The possible shifts and how they are encoded are described in *Constant shifts applied to a register* on page A5-10.

A special case is that if `ADD<c> <Rd>, <Rn>, <Rd>` is written and cannot be encoded using encoding T1, it is assembled using encoding T2 as though `ADD<c> <Rd>, <Rn>` had been written. To prevent this happening, use the `.W` qualifier.

The pre-UAL syntax `ADD<c>S` is equivalent to `ADDS<c>`.

Operation

```
if ConditionPassed() then
    EncodingSpecificOperations();
    shifted = Shift(R[m], shift_t, shift_n, APSR.C);
    (result, carry, overflow) = AddWithCarry(R[n], shifted, '0');
    if d == 15 then
        ALUWritePC(result); // setflags is always FALSE here
    else
        R[d] = result;
        if setflags then
            APSR.N = result<31>;
            APSR.Z = IsZeroBit(result);
            APSR.C = carry;
            APSR.V = overflow;
```

Exceptions

None.

A5.7.5 ADD (SP plus immediate)

This instruction adds an immediate value to the SP value, and writes the result to the destination register.

Encodings

T1 ADD<c> <Rd>,SP,#<imm>

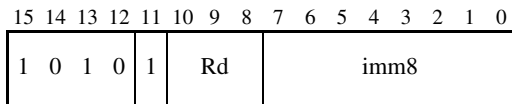

```
d = UInt(Rd); setflags = FALSE; imm32 = ZeroExtend(imm8:'00', 32);
```

T2 ADD<c> SP,SP,#<imm>

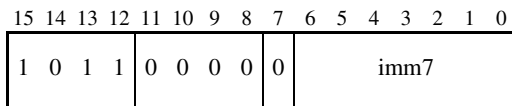

```
d = 13; setflags = FALSE; imm32 = ZeroExtend(imm7:'00', 32);
```

T3 ADD{S}<c>.W <Rd>,SP,#<const>

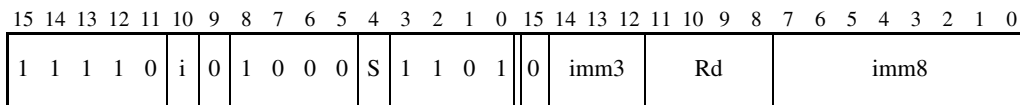

```
d = UInt(Rd); setflags = (S == '1');
imm32 = ThumbExpandImm(i:imm3:imm8);
if d == 15 && setflags then SEE CMN (immediate) on page A5-69;
if d == 15 then UNPREDICTABLE;
```

T4 ADDW<c> <Rd>,SP,#<imm>

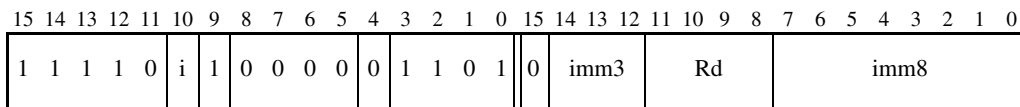

```
d = UInt(Rd); setflags = FALSE; imm32 = ZeroExtend(i:imm3:imm8, 32);
if d == 15 then UNPREDICTABLE;
```

Architecture versions

Encodings T1, T2 All versions of the Thumb instruction set.

Encodings T3, T4 All versions of the Thumb instruction set from Thumb-2 onwards.

Assembler syntax

ADD{S}<c><q> {<Rd>, } SP, #<const> All encodings permitted
 ADDW<c><q> {<Rd>, } SP, #<const> Only encoding T4 is permitted

where:

S If present, specifies that the instruction updates the flags. Otherwise, the instruction does not update the flags.

<c><q> See *Standard assembler syntax fields* on page A5-6.

<Rd> Specifies the destination register. If <Rd> is omitted, this register is SP.

<const> Specifies the immediate value to be added to the value obtained from <Rn>. Allowed values are multiples of 4 in the range 0-1020 for encoding T1, multiples of 4 in the range 0-508 for encoding T2 and any value in the range 0-4095 for encoding T4. See *Immediate constants* on page A5-8 for the range of allowed values for encoding T3.

When both 32-bit encodings are available for an instruction, encoding T3 is preferred to encoding T4 (if encoding T4 is required, use the ADDW syntax).

The pre-UAL syntax ADD<c>S is equivalent to ADDS<c>.

Operation

```
if ConditionPassed() then
    EncodingSpecificOperations();
    (result, carry, overflow) = AddWithCarry(SP, imm32, '0');
    R[d] = result;
    if setflags then
        APSR.N = result<31>;
        APSR.Z = IsZeroBit(result);
        APSR.C = carry;
        APSR.V = overflow;
```

Exceptions

None.

A5.7.6 ADD (SP plus register)

This instruction adds an optionally-shifted register value to the SP value, and writes the result to the destination register.

Encodings

T1 ADD<c> <Rdm>, SP, <Rdm>

15	14	13	12	11	10	9	8	7	6	5	4	3	2	1	0
0	1	0	0	0	1	0	0	DM	1	1	0	1	Rdm		

```
d = UInt(DM:Rdm); m = UInt(DM:Rdm); setflags = FALSE;
(shift_t, shift_n) = (SRType_None, 0);
```

T2 ADD<c> SP, <Rm>

15	14	13	12	11	10	9	8	7	6	5	4	3	2	1	0
0	1	0	0	0	1	0	0	1	Rm			1	0	1	

```
d = 13; m = UInt(Rm); setflags = FALSE;
(shift_t, shift_n) = (SRType_None, 0);
if m == 13 then SEE encoding T1
```

T3 ADD{S}<c>.W <Rd>, SP, <Rm>{, <shift>}

15	14	13	12	11	10	9	8	7	6	5	4	3	2	1	0	15	14	13	12	11	10	9	8	7	6	5	4	3	2	1	0
1	1	1	0	1	0	1	1	0	0	0	S	1	1	0	1	0	imm3			Rd	imm2	type	Rm								

```
d = UInt(Rd); m = UInt(Rm); setflags = (S == '1');
(shift_t, shift_n) = DecodeImmShift(type, imm3:imm2);
if d == 15 || BadReg(m) then UNPREDICTABLE;
```

Architecture versions

Encodings T1, T2 All versions of the Thumb instruction set.

Encoding T3 All versions of the Thumb instruction set from Thumb-2 onwards.

Assembler syntax

```
ADD{S}<c><q> {<Rd>}, SP, <Rm>{, <shift>}
```

where:

- S** If present, specifies that the instruction updates the flags. Otherwise, the instruction does not update the flags.
- <c><q>** See *Standard assembler syntax fields* on page A5-6.
- <Rd>** Specifies the destination register. If <Rd> is omitted, this register is SP.
- <Rm>** Specifies the register that is optionally shifted and used as the second operand.
- <shift>** Specifies the shift to apply to the value read from <Rm>. If <shift> is omitted, no shift is applied and all encodings are permitted. If <shift> is specified, only encoding T3 is permitted. The possible shifts and how they are encoded are described in *Constant shifts applied to a register* on page A5-10.

The pre-UAL syntax ADD<c>S is equivalent to ADDS<c>.

Operation

```
if ConditionPassed() then
    EncodingSpecificOperations();
    shifted = Shift(R[m], shift_t, shift_n, APSR.C);
    (result, carry, overflow) = AddWithCarry(SP, shifted, '0');
    R[d] = result;
    if setflags then
        APSR.N = result<31>;
        APSR.Z = IsZeroBit(result);
        APSR.C = carry;
        APSR.V = overflow;
```

Exceptions

None.

Assembler syntax

ADR<c><q>	<Rd>, <label>	Normal syntax
ADD<c><q>	<Rd>, PC, #<const>	Alternative for encodings T1, T3
SUB<c><q>	<Rd>, PC, #<const>	Alternative for encoding T2

where:

<c><q>	See <i>Standard assembler syntax fields</i> on page A5-6.
<Rd>	Specifies the destination register.
<label>	Specifies the label of an instruction or literal data item whose address is to be loaded into <Rd>. The assembler calculates the required value of the offset from the <code>Align(PC, 4)</code> value of the ADR instruction to this label. If the offset is positive, encodings T1 and T3 are permitted with <code>imm32</code> equal to the offset. Allowed values of the offset are multiples of four in the range 0 to 1020 for encoding T1 and any value in the range 0 to 4095 for encoding T3. If the offset is negative, encoding T2 is permitted with <code>imm32</code> equal to minus the offset. Allowed values of the offset are -4095 to -1.

In the alternative syntax forms:

<const>	Specifies the offset value for the ADD form and minus the offset value for the SUB form. Allowed values are multiples of four in the range 0 to 1020 for encoding T1 and any value in the range 0 to 4095 for encodings T2 and T3.
---------	--

Note

It is recommended that the alternative syntax forms are avoided where possible. However, the only possible syntax for encoding T2 with all immediate bits zero is
`SUB<c><q> <Rd>, PC, #0.`

Operation

```
if ConditionPassed() then
    EncodingSpecificOperations();
    base = Align(PC, 4);      // Word-aligned PC
    R[d] = if add then (base + imm32) else (base - imm32);
```

Exceptions

None.

A5.7.8 AND (immediate)

This instruction performs a bitwise AND of a register value and an immediate value, and writes the result to the destination register.

Encodings

T1 AND{S}<c> <Rd>, <Rn>, #<const>

15	14	13	12	11	10	9	8	7	6	5	4	3	2	1	0	15	14	13	12	11	10	9	8	7	6	5	4	3	2	1	0
1	1	1	1	0	i	0	0	0	0	0	S	Rn				0	imm3			Rd			imm8								

```
d = UInt(Rd); n = UInt(Rn); setflags = (S == '1');
(imm32, carry) = ThumbExpandImmWithC(i:imm3:imm8, APSR.C);
if d == 15 && setflags then SEE TST (immediate) on page A5-299;
if BadReg(d) || BadReg(n) then UNPREDICTABLE;
```

Architecture versions

Encoding T1 All versions of the Thumb instruction set from Thumb-2 onwards.

Assembler syntax

```
AND{S}<c><q> {<Rd>}, <Rn>, #<const>
```

where:

- S If present, specifies that the instruction updates the flags. Otherwise, the instruction does not update the flags.
- <c><q> See *Standard assembler syntax fields* on page A5-6.
- <Rd> Specifies the destination register. If <Rd> is omitted, this register is the same as <Rn>.
- <Rn> Specifies the register that contains the first operand.
- <const> Specifies the immediate value to be added to the value obtained from <Rn>. See *Immediate constants* on page A5-8 for the range of allowed values.

The pre-UAL syntax AND<c>S is equivalent to ANDS<c>.

Operation

```
if ConditionPassed() then
    EncodingSpecificOperations();
    result = R[n] AND imm32;
    R[d] = result;
    if setflags then
        APSR.N = result<31>;
        APSR.Z = IsZeroBit(result);
        APSR.C = carry;
        // APSR.V unchanged
```

Exceptions

None.

Assembler syntax

```
AND{S}<c><q> {<Rd>,<Rn>,<Rm> {,<shift>}}
```

where:

S	If present, specifies that the instruction updates the flags. Otherwise, the instruction does not update the flags.
<c><q>	See <i>Standard assembler syntax fields</i> on page A5-6.
<Rd>	Specifies the destination register. If <Rd> is omitted, this register is the same as <Rn>.
<Rn>	Specifies the register that contains the first operand.
<Rm>	Specifies the register that is optionally shifted and used as the second operand.
<shift>	Specifies the shift to apply to the value read from <Rm>. If <shift> is omitted, no shift is applied and both encodings are permitted. If <shift> is specified, only encoding T2 is permitted. The possible shifts and how they are encoded are described in <i>Constant shifts applied to a register</i> on page A5-10.

A special case is that if `AND<c> <Rd>,<Rn>,<Rd>` is written with <Rd> and <Rn> both in the range R0-R7, it will be assembled using encoding T2 as though `AND<c> <Rd>,<Rn>` had been written. To prevent this happening, use the .W qualifier.

The pre-UAL syntax `AND<c>S` is equivalent to `ANDS<c>`.

Operation

```
if ConditionPassed() then
    EncodingSpecificOperations();
    (shifted, carry) = Shift_C(R[m], shift_t, shift_n, APSR.C);
    result = R[n] AND shifted;
    R[d] = result;
    if setflags then
        APSR.N = result<31>;
        APSR.Z = IsZeroBit(result);
        APSR.C = carry;
        // APSR.V unchanged
```

Exceptions

None.

A5.7.10 ASR (immediate)

Arithmetic Shift Right (immediate) shifts a register value right by an immediate number of bits, shifting in copies of its sign bit, and writes the result to the destination register. It can optionally update the condition flags based on the result.

Encodings

T1 ASRS <Rd>, <Rm>, #<imm5> Outside IT block.
 ASR<c> <Rd>, <Rm>, #<imm5> Inside IT block.

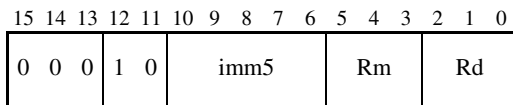

```
d = UInt(Rd); m = UInt(Rm); setflags = !InITBlock();
(-, shift_n) = DecodeImmShift('10', imm5);
```

T2 ASR{S}<c>.W <Rd>, <Rm>, #<imm5>

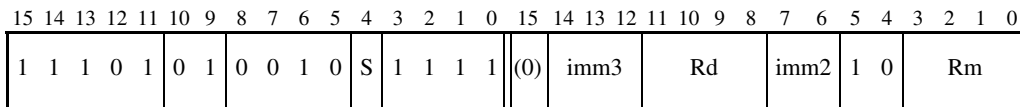

```
d = UInt(Rd); m = UInt(Rm); setflags = (S == '1');
(-, shift_n) = DecodeImmShift('10', imm3:imm2);
if BadReg(d) || BadReg(m) THEN UNPREDICTABLE;
```

Architecture versions

Encoding T1 All versions of the Thumb instruction set.

Encoding T2 All versions of the Thumb instruction set from Thumb-2 onwards.

Assembler syntax

```
ASR{S}<c><q> <Rd>, <Rm>, #<imm5>
```

where:

S	If present, specifies that the instruction updates the flags. Otherwise, the instruction does not update the flags.
<c><q>	See <i>Standard assembler syntax fields</i> on page A5-6.
<Rd>	Specifies the destination register.
<Rm>	Specifies the register that contains the first operand.
<imm5>	Specifies the shift amount, in the range 1 to 32. See <i>Constant shifts applied to a register</i> on page A5-10.

Operation

```
if ConditionPassed() then
    EncodingSpecificOperations();
    (result, carry) = Shift_C(R[m], SRTYPE_ASR, shift_n, APSR.C);
    R[d] = result;
    if setflags then
        APSR.N = result<31>;
        APSR.Z = IsZeroBit(result);
        APSR.C = carry;
        // APSR.V unchanged
```

Exceptions

None.

A5.7.11 ASR (register)

Arithmetic Shift Right (register) shifts a register value right by a variable number of bits, shifting in copies of its sign bit, and writes the result to the destination register. The variable number of bits is read from the bottom byte of a register. It can optionally update the condition flags based on the result.

Encodings

T1 ASRS <Rdn>, <Rm> Outside IT block.
 ASR<c> <Rdn>, <Rm> Inside IT block.

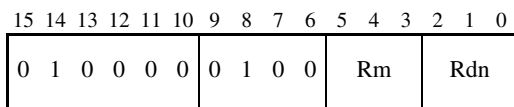

```
d = UInt(Rdn); n = UInt(Rdn); m = UInt(Rm); setflags = !InITBlock();
```

T2 ASR{S}<c>.W <Rd>, <Rn>, <Rm>

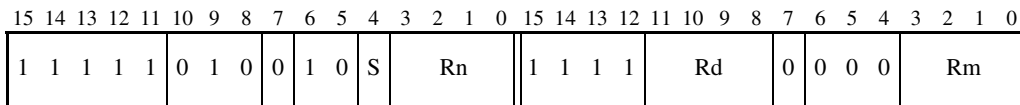

```
d = UInt(Rd); n = UInt(Rn); m = UInt(Rm); setflags = (S == '1');
if BadReg(d) || BadReg(n) || BadReg(m) then UNPREDICTABLE;
```

Architecture versions

Encoding T1 All versions of the Thumb instruction set

Encoding T2 All versions of the Thumb instruction set from Thumb-2 onwards.

Assembler syntax

ASR{S}<c><q> <Rd>, <Rn>, <Rm>

where:

S	If present, specifies that the instruction updates the flags. Otherwise, the instruction does not update the flags.
<c><q>	See <i>Standard assembler syntax fields</i> on page A5-6.
<Rd>	Specifies the destination register.
<Rn>	Specifies the register that contains the first operand.
<Rm>	Specifies the register whose bottom byte contains the amount to shift by.

Operation

```

if ConditionPassed() then
    EncodingSpecificOperations();
    shift_n = UInt(R[m]<7:0>);
    (result, carry) = Shift_C(R[n], SRType_ASR, shift_n, APSR.C);
    R[d] = result;
    if setflags then
        APSR.N = result<31>;
        APSR.Z = IsZeroBit(result);
        APSR.C = carry;
        // APSR.V unchanged

```

Exceptions

None.

A5.7.12 B

Branch causes a branch to a target address.

Encodings

T1 B<c> <label>

Not allowed in IT block.

15	14	13	12	11	10	9	8	7	6	5	4	3	2	1	0
1	1	0	1	cond				imm8							

```
imm32 = SignExtend(imm8:'0', 32);
if cond == '1110' then SEE Permanently undefined space on page A4-37;
if cond == '1111' then SEE SVC (formerly SWI) on page A5-285;
if InITBlock() then UNPREDICTABLE;
```

T2 B<c> <label>

Outside or last in IT block

15	14	13	12	11	10	9	8	7	6	5	4	3	2	1	0
1	1	1	0	0	imm11										

```
imm32 = SignExtend(imm11:'0', 32);
if InITBlock() && !LastInITBlock() then UNPREDICTABLE;
```

T3 B<c>.W <label>

Not allowed in IT block.

15	14	13	12	11	10	9	8	7	6	5	4	3	2	1	0	15	14	13	12	11	10	9	8	7	6	5	4	3	2	1	0
1	1	1	1	0	S	cond			imm6						1	0	J1	0	J2	imm11											

```
imm32 = SignExtend(S:J2:J1:imm6:imm11:'0', 32);
if cond<3:1> == '111' then
  SEE Branches, miscellaneous control instructions on page A4-30;
if InITBlock() then UNPREDICTABLE;
```

T4 B<c>.W <label>

Outside or last in IT block

15	14	13	12	11	10	9	8	7	6	5	4	3	2	1	0	15	14	13	12	11	10	9	8	7	6	5	4	3	2	1	0
1	1	1	1	0	S	imm10									1	0	J1	1	J2	imm11											

```
I1 = NOT(J1 EOR S); I2 = NOT(J2 EOR S);
imm32 = SignExtend(S:I1:I2:imm10:imm11:'0', 32);
if InITBlock() && !LastInITBlock() then UNPREDICTABLE;
```

Architecture versions

Encodings T1, T2 All versions of the Thumb instruction set

Encodings T3, T4 All versions of the Thumb instruction set from Thumb-2 onwards.

Assembler syntax

B<c><q> <label>

where:

<c><q> See *Standard assembler syntax fields* on page A5-6.

Note

Encodings T1 and T3 are conditional in their own right, and do not require an IT instruction to make them conditional.

For encodings T1 and T3, <c> is not allowed to be AL or omitted. The 4-bit encoding of the condition is placed in the instruction and not in a preceding IT instruction, and the instruction is not allowed to be in an IT block. As a result, encodings T1 and T2 are never both available to the assembler, nor are encodings T3 and T4.

<label> Specifies the label of the instruction that is to be branched to. The assembler calculates the required value of the offset from the PC value of the B instruction to this label, then selects an encoding that will set imm32 to that offset.

Allowed offsets are even numbers in the range -256 to 254 for encoding T1, -2048 to 2046 for encoding T2, -1048576 to 1048574 for encoding T3, and -16777216 to 16777214 for encoding T4.

Operation

```
if ConditionPassed() then
    EncodingSpecificOperations();
    BranchWritePC(PC + imm32);
```

Exceptions

None.

A5.7.13 BFC

Bit Field Clear clears any number of adjacent bits at any position in a register, without affecting the other bits in the register.

Encodings

T1 BFC<c> <Rd>, #<lsb>, #<width>

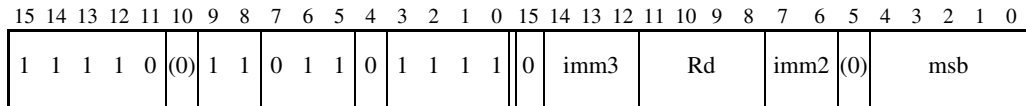

```
d = UInt(Rd); msbit = UInt(msb); lsbit = UInt(imm3:imm2);
if BadReg(d) then UNPREDICTABLE;
```

Architecture versions

Encoding T1 All versions of the Thumb instruction set from Thumb-2 onwards.

Assembler syntax

```
BFC<c><q> <Rd>, #<lsb>, #<width>
```

where:

- <c><q> See *Standard assembler syntax fields* on page A5-6.
- <Rd> Specifies the destination register.
- <lsb> Specifies the least significant bit that is to be cleared, in the range 0 to 31. This determines the required value of `lsbit`.
- <width> Specifies the number of bits to be cleared, in the range 1 to 32-<lsb>. The required value of `msbit` is `<lsb>+<width>-1`.

Operation

```
if ConditionPassed() then
    EncodingSpecificOperations();
    if msbit >= lsbit then
        R[d]<msbit:lsbit> = Replicate('0', msbit-lsbit+1);
        // Other bits of R[d] are unchanged
    else
        UNPREDICTABLE;
```

Exceptions

None.

A5.7.14 BFI

Bit Field Insert copies any number of low order bits from a register into the same number of adjacent bits at any position in the destination register.

Encodings

T1 BFI<c> <Rd>, <Rn>, #<lsb>, #<width>

15	14	13	12	11	10	9	8	7	6	5	4	3	2	1	0	15	14	13	12	11	10	9	8	7	6	5	4	3	2	1	0
1	1	1	1	0	(0)	1	1	0	1	1	0	Rn				0	imm3			Rd			imm2	(0)	msb						

```
d = UInt(Rd); n = UInt(Rn); msbit = UInt(msb); lsbit = UInt(imm3:imm2);
if n == 15 then SEE BFC on page A5-43;
if BadReg(d) || n == 13 then UNPREDICTABLE;
```

Architecture versions

Encoding T1 All versions of the Thumb instruction set from Thumb-2 onwards.

Assembler syntax

```
BFI<c><q> <Rd>, <Rn>, #<lsb>, #<width>
```

where:

- <c><q> See *Standard assembler syntax fields* on page A5-6.
- <Rd> Specifies the destination register.
- <Rn> Specifies the source register.
- <lsb> Specifies the least significant destination bit.
- <width> Specifies the number of bits to be copied.

Operation

```
if ConditionPassed() then
    EncodingSpecificOperations();
    if msbit >= lsbit then
        R[d]<msbit:lsbit> = R[n]<msbit-lsbit>:0;
        // Other bits of R[d] are unchanged
    else
        UNPREDICTABLE;
```

Exceptions

None.

A5.7.15 BIC (immediate)

Bit Clear (immediate) performs a bitwise AND of a register value and the complement of an immediate value, and writes the result to the destination register. It can optionally update the condition flags based on the result.

Encodings

T1 BIC{S}<c> <Rd>, <Rn>, #<const>

15	14	13	12	11	10	9	8	7	6	5	4	3	2	1	0	15	14	13	12	11	10	9	8	7	6	5	4	3	2	1	0
1	1	1	1	0	i	0	0	0	0	1	S	Rn				0	imm3			Rd				imm8							

```
d = UInt(Rd); n = UInt(Rn); setflags = (S == '1');
(imm32, carry) = ThumbExpandImmWithC(i:imm3:imm8, APSR.C);
if BadReg(d) || BadReg(n) then UNPREDICTABLE;
```

Architecture versions

Encoding T1 All versions of the Thumb instruction set from Thumb-2 onwards.

Assembler syntax

```
BIC{S}<c><q> {<Rd>, } <Rn>, #<const>
```

where:

- S If present, specifies that the instruction updates the flags. Otherwise, the instruction does not update the flags.
- <c><q> See *Standard assembler syntax fields* on page A5-6.
- <Rd> Specifies the destination register. If <Rd> is omitted, this register is the same as <Rn>.
- <Rn> Specifies the register that contains the operand.
- <const> Specifies the immediate value to be added to the value obtained from <Rn>. See *Immediate constants* on page A5-8 for the range of allowed values.

The pre-UAL syntax BIC<c>S is equivalent to BICS<c>.

Operation

```
if ConditionPassed() then
    EncodingSpecificOperations();
    result = R[n] AND NOT(imm32);
    R[d] = result;
    if setflags then
        APSR.N = result<31>;
        APSR.Z = IsZeroBit(result);
        APSR.C = carry;
        // APSR.V unchanged
```

Exceptions

None.

A5.7.16 BIC (register)

Bit Clear (register) performs a bitwise AND of a register value and the complement of an optionally-shifted register value, and writes the result to the destination register. It can optionally update the condition flags based on the result.

Encodings

T1 BICS <Rdn>, <Rm> Outside IT block.
 BIC<c> <Rdn>, <Rm> Inside IT block.

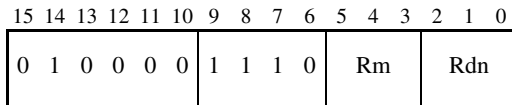

```
d = UInt(Rdn); n = UInt(Rdn); m = UInt(Rm); setflags = !InITBlock();
(shift_t, shift_n) = (SType_None, 0);
```

T2 BIC{S}<c>.W <Rd>, <Rn>, <Rm>{, <shift>}

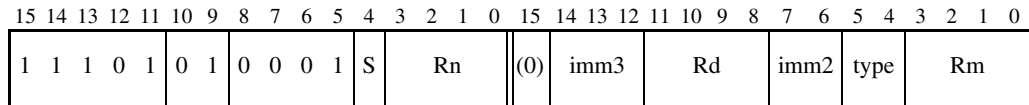

```
d = UInt(Rd); n = UInt(Rn); m = UInt(Rm); setflags = (S == '1');
(shift_t, shift_n) = DecodeImmShift(type, imm3:imm2);
if BadReg(d) || BadReg(n) || BadReg(m) THEN UNPREDICTABLE;
```

Architecture versions

Encoding T1 All versions of the Thumb instruction set

Encoding T2 All versions of the Thumb instruction set from Thumb-2 onwards.

Assembler syntax

```
BIC{S}<c><q> {<Rd>, } <Rn>, <Rm> {, <shift>}
```

where:

S	If present, specifies that the instruction updates the flags. Otherwise, the instruction does not update the flags.
<c><q>	See <i>Standard assembler syntax fields</i> on page A5-6.
<Rd>	Specifies the destination register. If <Rd> is omitted, this register is the same as <Rn>.
<Rn>	Specifies the register that contains the first operand.
<Rm>	Specifies the register that is optionally shifted and used as the second operand.
<shift>	Specifies the shift to apply to the value read from <Rm>. If <shift> is omitted, no shift is applied and both encodings are permitted. If <shift> is specified, only encoding T2 is permitted. The possible shifts and how they are encoded are described in <i>Constant shifts applied to a register</i> on page A5-10.

The pre-UAL syntax BIC<c>S is equivalent to BICS<c>.

Operation

```
if ConditionPassed() then
    EncodingSpecificOperations();
    (shifted, carry) = Shift_C(R[m], shift_t, shift_n, APSR.C);
    result = R[n] AND NOT(shifted);
    R[d] = result;
    if setflags then
        APSR.N = result<31>;
        APSR.Z = IsZeroBit(result);
        APSR.C = carry;
        // APSR.V unchanged
```

Exceptions

None.

A5.7.17 BKPT

Breakpoint causes a DebugMonitor exception or a debug halt to occur depending on the configuration of the debug support.

Encodings

T1 BKPT #<imm8>

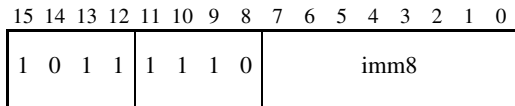

```
imm32 = ZeroExtend(imm8, 32);
// imm32 is for assembly/disassembly only and is ignored by hardware.
```

Architecture versions

Encoding T1 All versions of the Thumb instruction set from v5 onwards.

Assembler syntax

BKPT<q> #<imm8>

where:

<q> See *Standard assembler syntax fields* on page A5-6.

<imm8> Specifies an 8-bit value that is stored in the instruction. This value is ignored by the ARM hardware, but can be used by a debugger to store additional information about the breakpoint.

Operation

```
EncodingSpecificOperations();  
Breakpoint();
```

Exceptions

DebugMonitor.

A5.7.18 BL

Branch with Link (immediate) calls a subroutine at a PC-relative address.

Encodings

T1 BL<c> <label> Outside or last in IT block

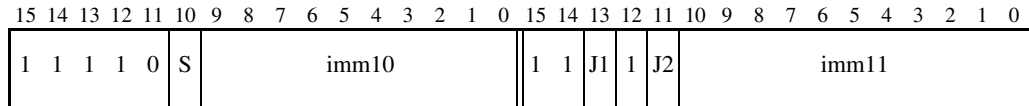

```
I1 = NOT(J1 EOR S); I2 = NOT(J2 EOR S);
imm32 = SignExtend(S:I1:I2:imm10:imm11:'0', 32);
if InITBlock() && !LastInITBlock() then UNPREDICTABLE;
```

Architecture versions

Encoding T1 All versions of the Thumb instruction set.

Before Thumb-2, J1 and J2 were both 1, resulting in a smaller branch range. The instructions could be executed as two separate 16-bit instructions, with the first instruction `instr1` setting LR to PC + `SignExtend(instr1<10:0>:'000000000000', 32)` and the second instruction completing the operation. This is no longer possible in Thumb-2.

Assembler syntax

BL<c><q> <label>

where:

<c><q> See *Standard assembler syntax fields* on page A5-6.

<label> Specifies the label of the instruction that is to be branched to.

The assembler calculates the required value of the offset from the PC value of the BL instruction to this label, then selects an encoding that will set imm32 to that offset. Allowed offsets are even numbers in the range -16777216 to 16777214.

Operation

```
if ConditionPassed() then
    EncodingSpecificOperations();
    next_instr_addr = PC;
    LR = next_instr_addr<31:1> : '1';
    SelectInstrSet(InstrSet_Thumb);
    BranchWritePC(PC + imm32);
```

Exceptions

None.

A5.7.19 BLX (register)

Branch and Exchange calls a subroutine at an address and instruction set specified by a register. ARMv7-M only supports the Thumb instruction set. An attempt to change the instruction execution state causes an exception.

Encodings

T1 BLX<c> <Rm>

Outside or last in IT block

15	14	13	12	11	10	9	8	7	6	5	4	3	2	1	0
0	1	0	0	0	1	1	1	1		Rm			(0)	(0)	(0)

```
m = UInt(Rm);
if m == 15 then UNPREDICTABLE;
if InITBlock() && !LastInITBlock() then UNPREDICTABLE;
```

Architecture versions

Encoding T1 All versions of the Thumb instruction set from v5 onwards.

Assembler syntax

BLX<c><q> <Rm>

where:

<c><q> See *Standard assembler syntax fields* on page A5-6.

<Rm> Specifies the register that contains the branch target address and instruction set selection bit.

Operation

```
if ConditionPassed() then
    EncodingSpecificOperations();
    next_instr_addr = PC - 2;
    LR = next_instr_addr<31:1> : '1';
    BXWritePC(R[m]);
```

Exceptions

UsageFault.

A5.7.20 BX

Branch and Exchange causes a branch to an address and instruction set specified by a register. ARMv7-M only supports the Thumb instruction set. An attempt to change the instruction execution state causes an exception.

Encodings

T1 BX<C> <Rm>

Outside or last in IT block

15	14	13	12	11	10	9	8	7	6	5	4	3	2	1	0
0	1	0	0	0	1	1	1	0	Rm	(0)	(0)	(0)			

```
m = UInt(Rm);
if InITBlock() && !LastInITBlock() then UNPREDICTABLE;
```

Architecture versions

Encoding T1 All versions of the Thumb instruction set.

Assembler syntax

`BX<c><q> <Rm>`

where:

`<c><q>` See *Standard assembler syntax fields* on page A5-6.

`<Rm>` Specifies the register that contains the branch target address and instruction set selection bit.

Operation

```
if ConditionPassed() then
    EncodingSpecificOperations();
    BXWritePC(R[m]);
```

Exceptions

UsageFault.

A5.7.21 CBNZ

Compare and Branch on Non-Zero compares the value in a register with zero, and conditionally branches forward a constant value. It does not affect the condition flags.

Encodings

T1 CBNZ <Rn>, <label>

Not allowed in IT block.

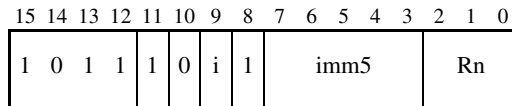

```
n = UInt(Rn); imm32 = ZeroExtend(i:imm5:'0', 32);
if InITBlock() then UNPREDICTABLE;
```

Architecture versions

Encoding T1 All versions of the Thumb instruction set from Thumb-2 onwards.

Assembler syntax

CBNZ<q> <Rn>, <label>

where:

- <q> See *Standard assembler syntax fields* on page A5-6.
- <Rn> Specifies the register that contains the first operand.
- <label> Specifies the label of the instruction that is to be branched to. The assembler calculates the required value of the offset from the PC value of the CBNZ instruction to this label, then selects an encoding that will set `imm32` to that offset. Allowed offsets are even numbers in the range 0 to 126.

Operation

```
EncodingSpecificOperations();  
if IsZeroBit(R[n]) == '0' then  
    BranchWritePC(PC + imm32);
```

Exceptions

None.

A5.7.22 CBZ

Compare and Branch on Zero compares the value in a register with zero, and conditionally branches forward a constant value. It does not affect the condition flags.

Encodings

T1 CBZ <Rn>, <label>

Not allowed in IT block.

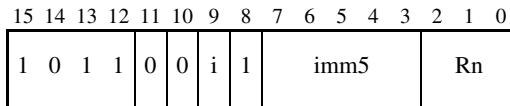

```
n = UInt(Rn); imm32 = ZeroExtend(i:imm5:'0', 32);
if InITBlock() then UNPREDICTABLE;
```

Architecture versions

Encoding T1 All versions of the Thumb instruction set from Thumb-2 onwards.

Assembler syntax

CBZ<q> <Rn>, <label>

where:

- <q> See *Standard assembler syntax fields* on page A5-6.
- <Rn> Specifies the register that contains the first operand.
- <label> Specifies the label of the instruction that is to be branched to. The assembler calculates the required value of the offset from the PC value of the CBZ instruction to this label, then selects an encoding that will set `imm32` to that offset. Allowed offsets are even numbers in the range 0 to 126.

Operation

```
EncodingSpecificOperations();  
if IsZeroBit(R[n]) == '1' then  
    BranchWritePC(PC + imm32);
```

Exceptions

None.

A5.7.23 CDP, CDP2

Coprocessor Data Processing tells a coprocessor to perform an operation that is independent of ARM registers and memory.

If no coprocessor can execute the instruction, a UsageFault exception is generated.

Encodings

T1 CDP<c> <coproc>, <opc1>, <CRd>, <CRn>, <CRm>, <opc2>

15	14	13	12	11	10	9	8	7	6	5	4	3	2	1	0	15	14	13	12	11	10	9	8	7	6	5	4	3	2	1	0	
1	1	1	C	1	1	1	0	opc1				CRn				CRd				coproc				opc2				0	CRm			

```
cp = UInt(coproc);  opc0 = C;  // CDP if C == '0', CDP2 if C == '1'
```

Architecture versions

Encoding T1 All versions of the Thumb instruction set from Thumb-2 onwards.

Assembler syntax

```
CDP{2}<c><q> <coproc>, #<opc1>, <CRd>, <CRn>, <CRm> {, #<opc2>}
```

where:

- 2 If specified, selects the C == 1 form of the encoding. If omitted, selects the C == 0 form.
- <c><q> See *Standard assembler syntax fields* on page A5-6.
- <coproc> Specifies the name of the coprocessor, and causes the corresponding coprocessor number to be placed in the cp_num field of the instruction. The standard generic coprocessor names are p0, p1, ..., p15.
- <opc1> Is a coprocessor-specific opcode, in the range 0 to 15.
- <CRd> Specifies the destination coprocessor register for the instruction.
- <CRn> Specifies the coprocessor register that contains the first operand.
- <CRm> Specifies the coprocessor register that contains the second operand.
- <opc2> Is a coprocessor-specific opcode in the range 0 to 7. If it is omitted, <opc2> is assumed to be 0.

Operation

```
if ConditionPassed() then
    EncodingSpecificOperations();
    if !Coprocc_Accepted(cp, ThisInstr()) then
        RaiseCoprocc_Exception();
    else
        Coproc_InternalOperation(cp, ThisInstr());
```

Exceptions

UsageFault.

Notes

- Coprocessor fields** Only instruction bits[31:24], bits[11:8], and bit[4] are architecturally defined. The remaining fields are recommendations.

A5.7.24 CLREX

Clear Exclusive clears the local record of the executing processor that an address has had a request for an exclusive access.

Encodings

T1 CLREX<c>

15	14	13	12	11	10	9	8	7	6	5	4	3	2	1	0	15	14	13	12	11	10	9	8	7	6	5	4	3	2	1	0
1	1	1	1	0	0	1	1	1	0	1	1	(1)	(1)	(1)	(1)	1	0	(0)	0	(1)	(1)	(1)	(1)	0	0	1	0	(1)	(1)	(1)	(1)

// Do nothing

Architecture versions

Encoding T1 All versions of the Thumb instruction set from v6K onwards.

Assembler syntax

CLREX<c><q>

where:

<c><q> See *Standard assembler syntax fields* on page A5-6.

Operation

```
if ConditionPassed() then
    EncodingSpecificOperations();
    ClearExclusiveMonitors();
```

Exceptions

None.

A5.7.25 CLZ

Count Leading Zeros returns the number of binary zero bits before the first binary one bit in a value.

Encoding

T1 CLZ<c> <Rd>, <Rm>

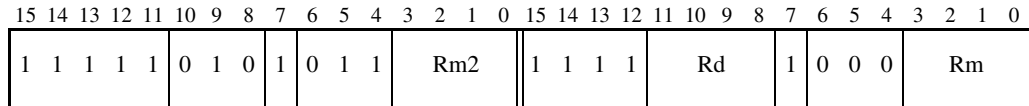

```
d = UInt(Rd); m = UInt(Rm); m2 = UInt(Rm2);
if BadReg(d) || BadReg(m) || m2 != m then UNPREDICTABLE;
```

Architecture versions

Encoding T1 All versions of the Thumb instruction set from Thumb-2 onwards.

Assembler syntax

CLZ<c><q> <Rd>, <Rm>

where:

- <c><q> See *Standard assembler syntax fields* on page A5-6.
- <Rd> Specifies the destination register.
- <Rm> Specifies the register that contains the operand. Its number must be encoded twice in encoding T1, in both the Rm and Rm2 fields.

Operation

```
if ConditionPassed() then
    EncodingSpecificOperations();
    result = 31 - HighestSetBit(R[m]); // = 32 if R[m] is zero
    R[d] = result<31:0>;
```

Exceptions

None.

A5.7.26 CMN (immediate)

Compare Negative (immediate) adds a register value and an immediate value. It updates the condition flags based on the result, and discards the result.

Encodings

T1 CMN<c> <Rn>, #<const>

15	14	13	12	11	10	9	8	7	6	5	4	3	2	1	0	15	14	13	12	11	10	9	8	7	6	5	4	3	2	1	0
1	1	1	1	0	i	0	1	0	0	0	1	Rn				0	imm3			1	1	1	1	imm8							

```
n = UInt(Rn); imm32 = ThumbExpandImm(i:imm3:imm8);
if n == 15 then UNPREDICTABLE;
```

Architecture versions

Encoding T1 All versions of the Thumb instruction set from Thumb-2 onwards.

Assembler syntax

CMN<c><q> <Rn>, #<const>

where:

<c><q> See *Standard assembler syntax fields* on page A5-6.

<Rn> Specifies the register that contains the operand. This register is allowed to be the SP.

<const> Specifies the immediate value to be added to the value obtained from <Rn>. See *Immediate constants* on page A5-8 for the range of allowed values.

Operation

```
if ConditionPassed() then
    EncodingSpecificOperations();
    (result, carry, overflow) = AddWithCarry(R[n], imm32, '0');
    APSR.N = result<31>;
    APSR.Z = IsZeroBit(result);
    APSR.C = carry;
    APSR.V = overflow;
```

Exceptions

None.

A5.7.27 CMN (register)

Compare Negative (register) adds a register value and an optionally-shifted register value. It updates the condition flags based on the result, and discards the result.

Encodings

T1 CMN<c> <Rn>, <Rm>

15	14	13	12	11	10	9	8	7	6	5	4	3	2	1	0
0	1	0	0	0	0	1	0	1	1	Rm				Rn	

```
n = UInt(Rn); m = UInt(Rm);
(shift_t, shift_n) = (SRTYPE_None, 0);
```

T2 CMN<c>.W <Rn>, <Rm> {,<shift>}

15	14	13	12	11	10	9	8	7	6	5	4	3	2	1	0	15	14	13	12	11	10	9	8	7	6	5	4	3	2	1	0
1	1	1	0	1	0	1	1	0	0	0	1	Rn				(0)	imm3	1	1	1	1	imm2	type							Rm	

```
n = UInt(Rn); m = UInt(Rm);
(shift_t, shift_n) = DecodeImmShift(type, imm3:imm2);
if n == 15 || BadReg(m) then UNPREDICTABLE;
```

Architecture versions

Encoding T1 All versions of the Thumb instruction set

Encoding T2 All versions of the Thumb instruction set from Thumb-2 onwards.

Assembler syntax

```
CMN<c><q> <Rn>, <Rm> {,<shift>}
```

where:

- <c><q> See *Standard assembler syntax fields* on page A5-6.
- <Rn> Specifies the register that contains the first operand. This register is allowed to be the SP.
- <Rm> Specifies the register that is optionally shifted and used as the second operand.
- <shift> Specifies the shift to apply to the value read from <Rm>. If <shift> is omitted, no shift is applied and both encodings are permitted. If <shift> is specified, only encoding T2 is permitted. The possible shifts and how they are encoded are described in *Constant shifts applied to a register* on page A5-10.

Operation

```
if ConditionPassed() then
    EncodingSpecificOperations();
    shifted = Shift(R[m], shift_t, shift_n, APSR.C);
    (result, carry, overflow) = AddWithCarry(R[n], shifted, '0');
    APSR.N = result<31>;
    APSR.Z = IsZeroBit(result);
    APSR.C = carry;
    APSR.V = overflow;
```

Exceptions

None.

A5.7.28 CMP (immediate)

Compare (immediate) subtracts an immediate value from a register value. It updates the condition flags based on the result, and discards the result.

Encodings

T1 CMP<c> <Rn>, #<imm8>

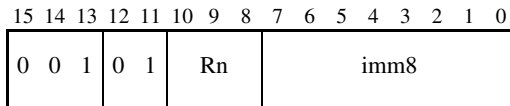

```
n = UInt(Rdn); imm32 = ZeroExtend(imm8, 32);
```

T2 CMP<c>.W <Rn>, #<const>

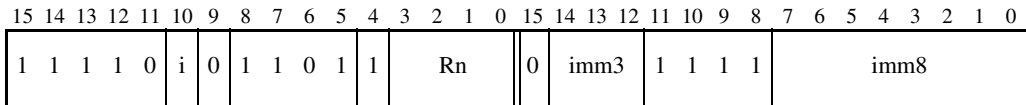

```
n = UInt(Rn); imm32 = ThumbExpandImm(i:imm3:imm8);
if n == 15 then UNPREDICTABLE;
```

Architecture versions

Encoding T1 All versions of the Thumb instruction set.

Encoding T2 All versions of the Thumb instruction set from Thumb-2 onwards.

Assembler syntax

`CMP<c><q> <Rn>, #<const>`

where:

- `<c><q>` See *Standard assembler syntax fields* on page A5-6.
- `<Rn>` Specifies the register that contains the operand. This register is allowed to be the SP.
- `<const>` Specifies the immediate value to be added to the value obtained from `<Rn>`. The range of allowed values is 0-255 for encoding T1. See *Immediate constants* on page A5-8 for the range of allowed values for encoding T2.

Operation

```
if ConditionPassed() then
    EncodingSpecificOperations();
    (result, carry, overflow) = AddWithCarry(R[n], NOT(imm32), '1');
    APSR.N = result<31>;
    APSR.Z = IsZeroBit(result);
    APSR.C = carry;
    APSR.V = overflow;
```

Exceptions

None.

A5.7.29 CMP (register)

Compare (register) subtracts an optionally-shifted register value from a register value. It updates the condition flags based on the result, and discards the result.

Encodings

T1 CMP<c> <Rn>, <Rm> <Rn> and <Rm> both from R0-R7

15	14	13	12	11	10	9	8	7	6	5	4	3	2	1	0
0	1	0	0	0	0	1	0	1	0	Rm	Rn				

```
n = UInt(Rn); m = UInt(Rm);
(shift_t, shift_n) = (SRTYPE_None, 0);
```

T2 CMP<c> <Rn>, <Rm> <Rn> and <Rm> not both from R0-R7

15	14	13	12	11	10	9	8	7	6	5	4	3	2	1	0
0	1	0	0	0	1	0	1	N	Rm			Rn			

```
n = UInt(N:Rn); m = UInt(Rm);
(shift_t, shift_n) = (SRTYPE_None, 0);
if n < 8 && m < 8 then UNPREDICTABLE;
if n == 15 then UNPREDICTABLE;
```

T3 CMP<c>.W <Rn>, <Rm> {,<shift>}

15	14	13	12	11	10	9	8	7	6	5	4	3	2	1	0	15	14	13	12	11	10	9	8	7	6	5	4	3	2	1	0
1	1	1	0	1	0	1	1	1	0	1	1	Rn			(0)	imm3	1	1	1	1	imm2	type	Rm								

```
n = UInt(Rn); m = UInt(Rm);
(shift_t, shift_n) = DecodeImmShift(type, imm3:imm2);
if n == 15 || BadReg(m) then UNPREDICTABLE;
```

Architecture versions

Encodings T1, T2 All versions of the Thumb instruction set.

Encoding T3 All versions of the Thumb instruction set from Thumb-2 onwards.

Assembler syntax

```
CMN<c><q> <Rn>, <Rm> {,<shift>}
```

where:

- <c><q> See *Standard assembler syntax fields* on page A5-6.
- <Rn> Specifies the register that contains the first operand. This register is allowed to be the SP.
- <Rm> Specifies the register that is optionally shifted and used as the second operand.
- <shift> Specifies the shift to apply to the value read from <Rm>. If <shift> is omitted, no shift is applied and all encodings are permitted. If shift is specified, only encoding T3 is permitted. The possible shifts and how they are encoded are described in *Constant shifts applied to a register* on page A5-10.

Operation

```
if ConditionPassed() then
    EncodingSpecificOperations();
    shifted = Shift(R[m], shift_t, shift_n, APSR.C);
    (result, carry, overflow) = AddWithCarry(R[n], NOT(shifted), '1');
    APSR.N = result<31>;
    APSR.Z = IsZeroBit(result);
    APSR.C = carry;
    APSR.V = overflow;
```

Exceptions

None.

A5.7.30 CPS

Change Processor State. The instruction modifies the PRIMASK and FAULTMASK special-purpose register values.

Encoding

T1 CPS<effect> <iflags>

Not allowed in IT block.

15	14	13	12	11	10	9	8	7	6	5	4	3	2	1	0
1	0	1	1	0	1	1	0	0	1	1	im	0	(0)	I	F

Architecture versions

Encoding T1 ARMv7-M specific behaviour. The instruction was introduced in v6, and is present in all versions of the Thumb instruction set from Thumb-2 onwards.

Note

CPS is a system level instruction. For the complete instruction definition see *CPS* on page B3-3.

A5.7.31 CPY

Copy is a pre-UAL synonym for MOV (register).

Assembler syntax

CPY <Rd>, <Rn>

This is equivalent to:

MOV <Rd>, <Rn>

Exceptions

None.

A5.7.32 DBG

Debug Hint provides a hint to debug trace support and related debug systems. See debug architecture documentation for what use (if any) is made of this instruction.

This is a NOP-compatible hint. See *NOP-compatible hints* on page A5-15 for general hint behavior.

Encodings

T1 DBG<c> #<option>

15	14	13	12	11	10	9	8	7	6	5	4	3	2	1	0	15	14	13	12	11	10	9	8	7	6	5	4	3	2	1	0
1	1	1	1	0	0	1	1	1	0	1	0	(1)	(1)	(1)	(1)	1	0	(0)	0	(0)	0	0	0	1	1	1	1	option			

// Do nothing

Architecture versions

Encoding T1 All versions of the Thumb instruction set from v7 onwards.

Assembler syntax

DBG<c><q> #<option>

where:

<c><q> See *Standard assembler syntax fields* on page A5-6.

<option> Provides extra information about the hint, and is in the range 0 to 15.

Operation

```
if ConditionPassed() then
    EncodingSpecificOperations();
    Hint_Debug(option);
```

Exceptions

None.

A5.7.33 DMB

Data Memory Barrier acts as a memory barrier. It ensures that all explicit memory accesses that appear in program order before the DMB instruction are observed before any explicit memory accesses that appear in program order after the DMB instruction. It does not affect the ordering of any other instructions executing on the processor.

Encodings

T1 DMB<c>

15	14	13	12	11	10	9	8	7	6	5	4	3	2	1	0	15	14	13	12	11	10	9	8	7	6	5	4	3	2	1	0
1	1	1	1	0	0	1	1	1	0	1	1	(1)	(1)	(1)	(1)	1	0	(0)	0	(1)	(1)	(1)	(1)	0	1	0	1	option			

// Do nothing

Architecture versions

Encoding T1 All versions of the Thumb instruction set from v7 onwards.

Assembler syntax

```
DMB<c><q> {<opt>}
```

where:

<c><q> See *Standard assembler syntax fields* on page A5-6.

<opt> Specifies an optional limitation on the DMB operation. Allowed values are:

SY Full system DMB operation, encoded as option == '1111'. Can be omitted.

All other encodings of option are RESERVED. The corresponding instructions execute as full system DMB operations, but should not be relied upon by software.

Operation

```
if ConditionPassed() then
    EncodingSpecificOperations();
    DataMemoryBarrier(option);
```

Exceptions

None.

A5.7.34 DSB

Data Synchronization Barrier acts as a special kind of memory barrier. No instruction in program order after this instruction can execute until this instruction completes. This instruction completes when:

- All explicit memory accesses before this instruction complete.
- All Cache, Branch predictor and TLB maintenance operations before this instruction complete.

Encodings

T1 DSB<c>

15	14	13	12	11	10	9	8	7	6	5	4	3	2	1	0	15	14	13	12	11	10	9	8	7	6	5	4	3	2	1	0
1	1	1	1	0	0	1	1	1	0	1	1	(1)	(1)	(1)	(1)	(1)	1	0	(0)	0	(1)	(1)	(1)	(1)	0	1	0	0	option		

// Do nothing

Architecture versions

Encoding T1 All versions of the Thumb instruction set from v7 onwards.

Assembler syntax

DSB<c><q> {<opt>}

where:

<c><q> See *Standard assembler syntax fields* on page A5-6.

<opt> Specifies an optional limitation on the DSB operation. Allowed values are:

SY	Full system DSB operation, encoded as option == '1111'. Can be omitted.
UN	DSB operation only out to the point of unification, encoded as option == '0111'.
ST	DSB operation that waits only for stores to complete, encoded as option == '1110'.
UNST	DSB operation that waits only for stores to complete and only out to the point of unification, encoded as option == '0110'.

All other encodings of option are RESERVED. The corresponding instructions execute as full system DSB operations, but should not be relied upon by software.

Operation

```
if ConditionPassed() then
    EncodingSpecificOperations();
    DataSynchronizationBarrier(option);
```

Exceptions

None.

A5.7.35 EOR (immediate)

Exclusive OR (immediate) performs a bitwise Exclusive OR of a register value and an immediate value, and writes the result to the destination register. It can optionally update the condition flags based on the result.

Encodings

T1 EOR{S}<c> <Rd>, <Rn>, #<const>

15	14	13	12	11	10	9	8	7	6	5	4	3	2	1	0	15	14	13	12	11	10	9	8	7	6	5	4	3	2	1	0
1	1	1	1	0	i	0	0	1	0	0	S	Rn				0	imm3			Rd			imm8								

```
d = UInt(Rd); n = UInt(Rn); setflags = (S == '1');
(imm32, carry) = ThumbExpandImmWithC(i:imm3:imm8, APSR.C);
if d == 15 && setflags then SEE TEQ (immediate) on page A5-295;
if BadReg(d) || BadReg(n) then UNPREDICTABLE;
```

Architecture versions

Encoding T1 All versions of the Thumb instruction set from Thumb-2 onwards.

Assembler syntax

```
EOR{S}<c><q> {<Rd>}, <Rn>, #<const>
```

where:

- S If present, specifies that the instruction updates the flags. Otherwise, the instruction does not update the flags.
- <c><q> See *Standard assembler syntax fields* on page A5-6.
- <Rd> Specifies the destination register. If <Rd> is omitted, this register is the same as <Rn>.
- <Rn> Specifies the register that contains the operand.
- <const> Specifies the immediate value to be added to the value obtained from <Rn>. See *Immediate constants* on page A5-8 for the range of allowed values.

The pre-UAL syntax EOR<c>S is equivalent to EORS<c>.

Operation

```
if ConditionPassed() then
    EncodingSpecificOperations();
    result = R[n] EOR imm32;
    R[d] = result;
    if setflags then
        APSR.N = result<31>;
        APSR.Z = IsZeroBit(result);
        APSR.C = carry;
        // APSR.V unchanged
```

Exceptions

None.

A5.7.36 EOR (register)

Exclusive OR (register) performs a bitwise Exclusive OR of a register value and an optionally-shifted register value, and writes the result to the destination register. It can optionally update the condition flags based on the result.

Encodings

T1 EORS <Rdn>, <Rm> Outside IT block.
 EOR<c> <Rdn>, <Rm> Inside IT block.

15	14	13	12	11	10	9	8	7	6	5	4	3	2	1	0
0 1 0 0 0 0						0 0 0 1				Rm		Rdn			

```
d = UInt(Rdn); n = UInt(Rdn); m = UInt(Rm); setflags = !InITBlock();
(shift_t, shift_n) = (SRTType_None, 0);
```

T2 EOR{S}<c>.W <Rd>, <Rn>, <Rm>{, <shift>}

15	14	13	12	11	10	9	8	7	6	5	4	3	2	1	0	15	14	13	12	11	10	9	8	7	6	5	4	3	2	1	0
1		1		1		0		1		0		1		0		0		S	Rn		(0)	imm3		Rd		imm2		type		Rm	

```
d = UInt(Rd); n = UInt(Rn); m = UInt(Rm); setflags = (S == '1');
(shift_t, shift_n) = DecodeImmShift(type, imm3:imm2);
if d == 15 && setflags then SEE TEQ (register) on page A5-297;
if BadReg(d) || BadReg(n) || BadReg(m) THEN UNPREDICTABLE;
```

Architecture versions

Encoding T1 All versions of the Thumb instruction set

Encoding T2 All versions of the Thumb instruction set from Thumb-2 onwards.

Assembler syntax

```
EOR{S}<c><q> {<Rd>,<Rn>,<Rm> {,<shift>}}
```

where:

- S If present, specifies that the instruction updates the flags. Otherwise, the instruction does not update the flags.
- <c><q> See *Standard assembler syntax fields* on page A5-6.
- <Rd> Specifies the destination register. If <Rd> is omitted, this register is the same as <Rn>.
- <Rn> Specifies the register that contains the first operand.
- <Rm> Specifies the register that is optionally shifted and used as the second operand.
- <shift> Specifies the shift to apply to the value read from <Rm>. If <shift> is omitted, no shift is applied and both encodings are permitted. If <shift> is specified, only encoding T2 is permitted. The possible shifts and how they are encoded are described in *Constant shifts applied to a register* on page A5-10.

A special case is that if EOR<c> <Rd>,<Rn>,<Rd> is written with <Rd> and <Rn> both in the range R0-R7, it will be assembled using encoding T2 as though EOR<c> <Rd>,<Rn> had been written. To prevent this happening, use the .W qualifier.

The pre-UAL syntax EOR<c>S is equivalent to EORS<c>.

Operation

```
if ConditionPassed() then
    EncodingSpecificOperations();
    (shifted, carry) = Shift_C(R[m], shift_t, shift_n, APSR.C);
    result = R[n] EOR shifted;
    R[d] = result;
    if setflags then
        APSR.N = result<31>;
        APSR.Z = IsZeroBit(result);
        APSR.C = carry;
        // APSR.V unchanged
```

Exceptions

None.

A5.7.37 ISB

Instruction Synchronization Barrier flushes the pipeline in the processor, so that all instructions following the ISB are fetched from cache or memory, after the instruction has been completed. It ensures that the effects of context altering operations, such as changing the ASID, or completed TLB maintenance operations, or branch predictor maintenance operations, as well as all changes to the CP15 registers, executed before the ISB instruction are visible to the instructions fetched after the ISB.

In addition, the ISB instruction ensures that any branches that appear in program order after it are always written into the branch prediction logic with the context that is visible after the ISB instruction. This is required to ensure correct execution of the instruction stream.

Encodings

T1 ISB<C>

15	14	13	12	11	10	9	8	7	6	5	4	3	2	1	0	15	14	13	12	11	10	9	8	7	6	5	4	3	2	1	0
1	1	1	1	0	0	1	1	1	0	1	1	(1)	(1)	(1)	(1)	1	0	(0)	0	(1)	(1)	(1)	(1)	0	1	1	0	option			

// Do nothing

Architecture versions

Encoding T1 All versions of the Thumb instruction set from v7 onwards.

Assembler syntax

```
ISB<c><q> {<opt>}
```

where:

<c><q> See *Standard assembler syntax fields* on page A5-6.

<opt> Specifies an optional limitation on the ISB operation. Allowed values are:

SY Full system ISB operation, encoded as option == '1111'. Can be omitted.

All other encodings of option are RESERVED. The corresponding instructions execute as full system ISB operations, but should not be relied upon by software.

Operation

```
if ConditionPassed() then
    EncodingSpecificOperations();
    InstructionSynchronizationBarrier(option);
```

Exceptions

None.

A5.7.38 IT

If Then makes up to four following instructions (the *IT block*) conditional. The conditions for the instructions in the IT block can be the same, or some of them can be the inverse of others.

IT does not affect the condition code flags. Branches to any instruction in the IT block are not permitted, apart from those performed by exception returns.

16-bit instructions in the IT block, other than CMP, CMN and TST, do not set the condition code flags. The AL condition can be specified to get this changed behavior without conditional execution.

Encodings

T1 IT{x{y{z}}} <firstcond> Not allowed in IT block

15	14	13	12	11	10	9	8	7	6	5	4	3	2	1	0
1	0	1	1	1	1	1	1	firstcond	mask						

```
if mask == '0000' then see NOP-compatible hints on page A5-15
if firstcond == '1111' then UNPREDICTABLE;
if firstcond == '1110' && BitCount(mask) != 1 then UNPREDICTABLE;
if InITBlock() then UNPREDICTABLE;
```

Architecture versions

Encoding T1 All versions of the Thumb instruction set from Thumb-2 onwards.

Assembler syntax

IT{x{y{z}}}<q> <firstcond>

where:

<x> Specifies the condition for the second instruction in the IT block.

<y> Specifies the condition for the third instruction in the IT block.

<z> Specifies the condition for the fourth instruction in the IT block.

<q> See *Standard assembler syntax fields* on page A5-6.

<firstcond> Specifies the condition for the first instruction in the IT block.

Each of <x>, <y>, and <z> can be either:

T Then. The condition attached to the instruction is <firstcond>.

E Else. The condition attached to the instruction is the inverse of <firstcond>. The condition code is the same as <firstcond>, except that the least significant bit is inverted. E must not be specified if <firstcond> is AL.

The values of <x>, <y>, and <z> determine the value of the mask field as shown in Table A5-1.

Table A5-1 Determination of mask^a field

<x>	<y>	<z>	mask[3]	mask[2]	mask[1]	mask[0]
omitted	omitted	omitted	1	0	0	0
T	omitted	omitted	firstcond[0]	1	0	0
E	omitted	omitted	NOT firstcond[0]	1	0	0
T	T	omitted	firstcond[0]	firstcond[0]	1	0
E	T	omitted	NOT firstcond[0]	firstcond[0]	1	0
T	E	omitted	firstcond[0]	NOT firstcond[0]	1	0
E	E	omitted	NOT firstcond[0]	NOT firstcond[0]	1	0
T	T	T	firstcond[0]	firstcond[0]	firstcond[0]	1
E	T	T	NOT firstcond[0]	firstcond[0]	firstcond[0]	1
T	E	T	firstcond[0]	NOT firstcond[0]	firstcond[0]	1
E	E	T	NOT firstcond[0]	NOT firstcond[0]	firstcond[0]	1
T	T	E	firstcond[0]	firstcond[0]	NOT firstcond[0]	1
E	T	E	NOT firstcond[0]	firstcond[0]	NOT firstcond[0]	1
T	E	E	firstcond[0]	NOT firstcond[0]	NOT firstcond[0]	1
E	E	E	NOT firstcond[0]	NOT firstcond[0]	NOT firstcond[0]	1

a. Note that at least one bit is always 1 in mask.

See also *The IT execution state bits* on page A4-35.

Operation

```
EncodingSpecificOperations();
StartITBlock(firstcond, mask);
```

Exceptions

None.

A5.7.39 LDC, LDC2

Load Coprocessor loads memory data from a sequence of consecutive memory addresses to a coprocessor.

If no coprocessor can execute the instruction, a UsageFault exception is generated.

Encoding

T1 LDC{2}{L}<c> <coproc>, <CRd>, [<Rn>, #+/-<imm8>]
 LDC{2}{L}<c> <coproc>, <CRd>, [<Rn>], #+/-<imm8>
 LDC{2}{L}<c> <coproc>, <CRd>, [<Rn>, #+/-<imm8>!]
 LDC{2}{L}<c> <coproc>, <CRd>, [<Rn>], <option>

15	14	13	12	11	10	9	8	7	6	5	4	3	2	1	0	15	14	13	12	11	10	9	8	7	6	5	4	3	2	1	0
1	1	1	C	1	1	0	P	U	N	W	1	Rn				CRd				coproc				imm8							

```
n = UInt(Rn); cp = UInt(coproc); imm32 = ZeroExtend(imm8:'00', 32);
opc1 = N; opc0 = C; // LDC if C == '0', LDC2 if C == '1'
index = (P == '1'); add = (U == '1'); wback = (W == '1');
if P == '0' && U == '0' && N == '0' && W == '0' then UNDEFINED;
if P == '0' && U == '0' && N == '1' && W == '0' then
    SEE MRRRC, MRRRC2 on page A5-176;
if n == 15 && wback then UNPREDICTABLE;
```

Architecture versions

Encoding T1 All versions of the Thumb instruction set from Thumb-2 onwards.

Assembler syntax

LDC{2}{L}<c><q> <coproc>, <CRd>, [<Rn>{, #+/-<imm>}]	index==TRUE, wback==FALSE
LDC{2}{L}<c><q> <coproc>, <CRd>, [<Rn>, #+/-<imm>!]	index==TRUE, wback==TRUE
LDC{2}{L}<c><q> <coproc>, <CRd>, [<Rn>], #+/-<imm>	index==FALSE, wback==TRUE
LDC{2}{L}<c><q> <coproc>, <CRd>, [<Rn>], <option>	index==FALSE, wback==TRUE, add==TRUE

where:

- 2 If specified, selects the C == 1 form of the encoding. If omitted, selects the C == 0 form.
- L If specified, selects the N == 1 form of the encoding. If omitted, selects the N == 0 form.
- <c><q> See *Standard assembler syntax fields* on page A5-6.
- <coproc> Specifies the name of the coprocessor. The standard generic coprocessor names are p0, p1, ..., p15.

<CRd>	Specifies the coprocessor destination register.
<Rn>	Specifies the base register. This register is allowed to be the SP or PC.
+/-	Is + or omitted to indicate that the immediate offset is added to the base register value (add == TRUE), or - to indicate that the offset is to be subtracted (add == FALSE). Different instructions are generated for #0 and #-0.
<imm>	Specifies the immediate offset added to or subtracted from the value of <Rn> to form the address. Allowed values are multiples of 4 in the range 0-1020. For the offset addressing syntax, <imm> can be omitted, meaning an offset of 0.
<option>	Specifies additional instruction options to the coprocessor, as an integer in the range 0-255, surrounded by { and }. This integer is encoded in the imm8 field of the instruction.

The pre-UAL syntax LDC<C>L is equivalent to LDCL<C>.

Operation

```

if ConditionPassed() then
    EncodingSpecificOperations();
    if !Coprocc_Accepted(cp, ThisInstr()) then
        RaiseCoproccorException();
    else
        base = if n == 15 then Align(PC,4) else R(n);
        offset_addr = if add then (base + imm32) else (base - imm32);
        address = if index then offset_addr else base;
        if wback then R[n] = offset_addr;
        repeat
            value = MemA[address,4];
            Coproc_SendLoadedWord(value, cp, ThisInstr());
            address = address + 4;
        until Coproc_DoneLoading(cp, ThisInstr());
    
```

Exceptions

UsageFault, MemManage, BusFault.

Notes

Coprocessor fields Only instruction bits[31:23], bits[21:16], and bits[11:0] are ARM architecture-defined. The remaining fields (bit[22] and bits[15:12]) are recommendations.

In the case of the Unindexed addressing mode (P==0, U==1, W==0), instruction bits[7:0] are also not defined by the ARM architecture, and can be used to specify additional coprocessor options.

A5.7.40 LDMDB / LDMEA

Load Multiple Decrement Before (Load Multiple Empty Ascending) loads multiple registers from sequential memory locations using an address from a base register. The sequential memory locations end just below this address, and the address of the first of those locations can optionally be written back to the base register.

The registers loaded can include the PC. If they do, the word loaded for the PC is treated as an address or exception return value and a branch occurs. Bit[0] complies with the ARM architecture interworking rules for branches to Thumb state execution and must be 1. If bit[0] is 0, a UsageFault exception occurs.

Encoding

T1 LDMDB<c> <Rn>{!}, <registers>

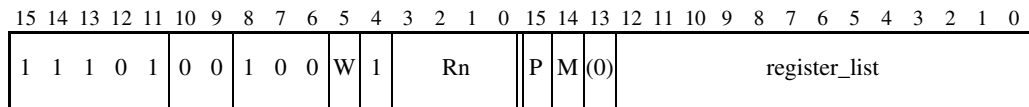

```
n = UInt(Rn); registers = P:M:'0':register_list; wback = (W == '1');
if n == 15 || BitCount(registers) < 2 then UNPREDICTABLE;
if P == 1 && M == 1 then UNPREDICTABLE;
if registers<15> == 1 && InITBlock() && !LastInITBlock() then UNPREDICTABLE;
```

Architecture versions

Encoding T1 All versions of the Thumb instruction set from Thumb-2 onwards.

Assembler syntax

LDMDB<c><q> <Rn>{!}, <registers>

where:

<c><q> See *Standard assembler syntax fields* on page A5-6.

<Rn> Specifies the base register. This register is allowed to be the SP.

! Causes the instruction to write a modified value back to <Rn>. If ! is omitted, the instruction does not change <Rn> in this way. (However, if <Rn> is included in <registers>, it changes when a value is loaded into it.)

<registers>

Is a list of one or more registers, separated by commas and surrounded by { and }. It specifies the set of registers to be loaded. The registers are loaded with the lowest-numbered register from the lowest memory address, through to the highest-numbered register from the highest memory address. If the PC is specified in the register list, the instruction causes a branch to the address (data) loaded into the PC.

Encoding T1 does not support a list containing only one register. If an LDMDB instruction with just one register <Rt> in the list is assembled to Thumb, it is assembled to the equivalent LDR<c><q> <Rt>, [<Rn>, #-4] {!} instruction.

The SP cannot be in the list.

If the PC is in the list, the LR must not be in the list and the instruction must either be outside an IT block or the last instruction in an IT block.

LDMEA is a synonym for LDMDB, referring to its use for popping data from Empty Ascending stacks.

The pre-UAL syntaxes LDM<c>DB and LDM<c>EA are equivalent to LDMDB<c>.

Operation

```

if ConditionPassed() then
    EncodingSpecificOperations();
    originalRn = R[n];
    address = R[n] - 4*BitCount(registers);
    if wback then
        if registers<n> == '0' then
            R[n] = R[n] - 4*BitCount(registers);
        else
            R[n] = bits(32) UNKNOWN;
    for i = 0 to 14
        if registers<i> == '1' then
            loadedvalue = MemA[address,4];
            if !(i == n && wback) then
                R[i] = loadedvalue;
            // else R[i] set earlier to be bits[32] UNKNOWN
            address = address + 4;
    if registers<15> == '1' then
        LoadWritePC(MemA[address,4]);
        address = address + 4;
    assert address == originalRn;

```

Exceptions

UsageFault, MemManage, BusFault.

<Rn>	Specifies the base register. This register is allowed to be the SP. If it is the SP and ! is specified, it is treated as described in <i>POP</i> on page A5-206.
!	Causes the instruction to write a modified value back to <Rn>. If ! is omitted, the instruction does not change <Rn> in this way. (However, if <Rn> is included in <registers>, it changes when a value is loaded into it.)
<registers>	Is a list of one or more registers, separated by commas and surrounded by { and }. It specifies the set of registers to be loaded by the LDM instruction. The registers are loaded with the lowest-numbered register from the lowest memory address, through to the highest-numbered register from the highest memory address. If the PC is specified in the register list, the instruction causes a branch to the address (data) loaded into the PC. Encoding T2 does not support a list containing only one register. If an LDMIA instruction with just one register <Rt> in the list is assembled to Thumb and encoding T1 is not available, it is assembled to the equivalent LDR<c><q><Rt>, [<Rn>] { , #-4 } instruction. The SP cannot be in the list. If the PC is in the list, the LR must not be in the list and the instruction must either be outside an IT block or the last instruction in an IT block.

LDMFD is a synonym for LDMIA, referring to its use for popping data from Full Descending stacks.

The pre-UAL syntaxes LDM<c>IA and LDM<c>FD are equivalent to LDMIA<c>.

Operation

```

if ConditionPassed() then
    EncodingSpecificOperations();
    originalRn = R[n];
    address = R[n];
    if wback then
        if registers<n> == '0' then
            R[n] = R[n] + 4*BitCount(registers);
        else
            R[n] = bits(32) UNKNOWN;
    for i = 0 to 14
        if registers<i> == '1' then
            loadedvalue = MemA[address,4];
            if !(i == n && wback) then
                R[i] = loadedvalue;
            // else R[i] set earlier to be bits[32] UNKNOWN
            address = address + 4;
    if registers<15> == '1' then
        LoadWritePC(MemA[address,4]);
        address = address + 4;
    assert address == originalRn + 4*BitCount(registers);

```

Exceptions

UsageFault, MemManage, BusFault.

A5.7.42 LDR (immediate)

Load Register (immediate) calculates an address from a base register value and an immediate offset, loads a word from memory, and writes it to a register. It can use offset, post-indexed, or pre-indexed addressing. See *Memory accesses* on page A5-13 for information about memory accesses.

The register loaded can be the PC. If it is, the word loaded for the PC is treated as an address or exception return value and a branch occurs. Bit[0] complies with the ARM architecture interworking rules for branches to Thumb state execution and must be 1. If bit[0] is 0, a UsageFault exception occurs.

Encoding

T1 LDR<c> <Rt>, [<Rn>, #<imm>]

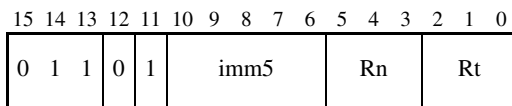

```
t = UInt(Rt); n = UInt(Rn); imm32 = ZeroExtend(imm5:'00', 32);
index = TRUE; add = TRUE; wback = FALSE;
```

T2 LDR<c> <Rt>, [SP, #<imm>]

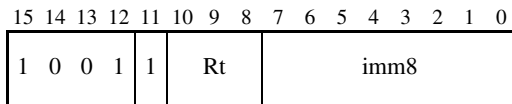

```
t = UInt(Rt); n = 13; imm32 = ZeroExtend(imm8:'00', 32);
index = TRUE; add = TRUE; wback = FALSE;
```

T3 LDR<c>.W <Rt>, [<Rn>, #<imm12>]

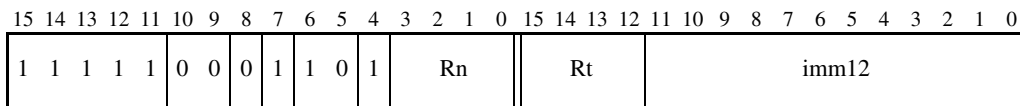

```
t = UInt(Rt); n = UInt(Rn); imm32 = ZeroExtend(imm12, 32);
index = TRUE; add = TRUE; wback = FALSE;
if n == 15 then SEE LDR (literal) on page A5-105;
if t == 15 && InITBlock() && !LastInITBlock() then UNPREDICTABLE;
```

T4 LDR<c> <Rt>, [<Rn>, #-<imm8>]
 LDR<c> <Rt>, [<Rn>], #+/-<imm8>
 LDR<c> <Rt>, [<Rn>, #+/-<imm8>]!

15	14	13	12	11	10	9	8	7	6	5	4	3	2	1	0	15	14	13	12	11	10	9	8	7	6	5	4	3	2	1	0
1	1	1	1	1	0	0	0	0	1	0	1	Rn				Rt				1	P	U	W	imm8							

```

t = UInt(Rt); n = UInt(Rn); imm32 = ZeroExtend(imm8, 32);
index = (P == '1'); add = (U == '1'); wback = (W == '1');
if n == 15 then SEE LDR (literal) on page A5-105;
if P == '1' && U == '1' && W == '0' then SEE LDRT on page A5-149;
if P == '0' && W == '0' then UNDEFINED;
if wback && n == t then UNPREDICTABLE;
if t == 15 && InITBlock() && !LastInITBlock() then UNPREDICTABLE;

```

Architecture versions

Encodings T1, T2 All versions of the Thumb instruction set.

Encodings T3, T4 All versions of the Thumb instruction set from Thumb-2 onwards.

Assembler syntax

```

LDR<c><q> <Rt>, [<Rn> {, #+/-<imm>}]      Offset: index==TRUE, wback==FALSE
LDR<c><q> <Rt>, [<Rn>, #+/-<imm>]!        Pre-indexed: index==TRUE, wback==TRUE
LDR<c><q> <Rt>, [<Rn>], #+/-<imm>        Post-indexed: index==FALSE, wback==TRUE

```

where:

<c><q> See *Standard assembler syntax fields* on page A5-6.

<Rt> Specifies the destination register. This register is allowed to be the SP. It is also allowed to be the PC, provided the instruction is either outside an IT block or the last instruction of an IT block. If it is the PC, it causes a branch to the address (data) loaded into the PC.

<Rn> Specifies the base register. This register is allowed to be the SP. If this register is the PC, see *LDR (literal)* on page A5-105.

+/- Is + or omitted to indicate that the immediate offset is added to the base register value (add == TRUE), or - to indicate that the offset is to be subtracted (add == FALSE). Different instructions are generated for #0 and #-0.

<imm> Specifies the immediate offset added to or subtracted from the value of <Rn> to form the address. Allowed values are multiples of 4 in the range 0-124 for encoding T1, multiples of 4 in the range 0-1020 for encoding T2, any value in the range 0-4095 for encoding T3, and any value in the range 0-255 for encoding T4. For the offset addressing syntax, <imm> can be omitted, meaning an offset of 0.

Operation

```
if ConditionPassed() then
    EncodingSpecificOperations();
    offset_addr = if add then (R[n] + imm32) else (R[n] - imm32);
    address = if index then offset_addr else R[n];
    if wback then R[n] = offset_addr;
    if t == 15 then
        if address<1:0> != '00' then UNPREDICTABLE;
        LoadWritePC(MemU[address,4]);
    else
        R[t] = MemU[address,4];
```

Exceptions

UsageFault, MemManage, BusFault.

A5.7.43 LDR (literal)

Load Register (literal) calculates an address from the PC value and an immediate offset, loads a word from memory, and writes it to a register. See *Memory accesses* on page A5-13 for information about memory accesses.

The register loaded can be the PC. If it is, the word loaded for the PC is treated as an address or exception return value and a branch occurs. Bit[0] complies with the ARM architecture interworking rules for branches to Thumb state execution and must be 1. If bit[0] is 0, a UsageFault exception occurs.

Encoding

T1 LDR<c> <Rt>, [PC, #<imm>]

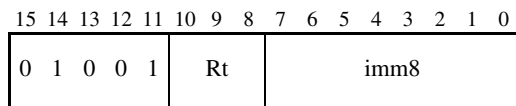

```
t = UInt(Rt); imm32 = ZeroExtend(imm8:'00', 32); add = TRUE;
```

T2 LDR<c>.W <Rt>, [PC, #+/-<imm12>]

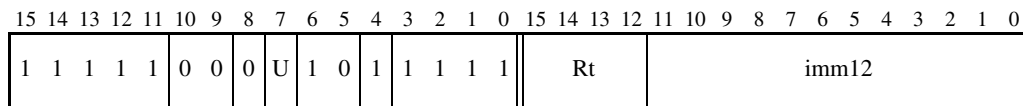

```
t = UInt(Rt); imm32 = ZeroExtend(imm12, 32); add = (U == '1');
if t == 15 && InITBlock() && !LastInITBlock() then UNPREDICTABLE;
```

Architecture versions

Encoding T1 All versions of the Thumb instruction set

Encoding T2 All versions of the Thumb instruction set from Thumb-2 onwards.

Assembler syntax

```
LDR<c><q> <Rt>, <label> Normal form
LDR<c><q> <Rt>, [PC, #+/-<imm>] Alternative form
```

where:

<c><q> See *Standard assembler syntax fields* on page A5-6.

<Rt> Specifies the destination register. This register is allowed to be the SP. It is also allowed to be the PC, provided the instruction is either outside an IT block or the last instruction of an IT block. If it is the PC, it causes a branch to the address (data) loaded into the PC.

<label> Specifies the label of the literal data item that is to be loaded into <Rt>. The assembler calculates the required value of the offset from the `Align(PC, 4)` value of this instruction to the label.

If the offset is positive, encodings T1 and T2 are permitted with `imm32` equal to the offset and `add == TRUE`. Allowed values of the offset are multiples of four in the range 0 to 1020 for encoding T1 and any value in the range 0 to 4095 for encoding T2.

If the offset is negative, encoding T2 is permitted with `imm32` equal to minus the offset and `add == FALSE`. Allowed values of the offset are -4095 to -1.

In the alternative syntax form:

+/- Is + or omitted to indicate that the immediate offset is added to the `Align(PC, 4)` value (`add == TRUE`), or - to indicate that the offset is to be subtracted (`add == FALSE`). Different instructions are generated for #0 and #-0.

<imm> Specifies the immediate offset added to or subtracted from the `Align(PC, 4)` value of the instruction to form the address. Allowed values are multiples of four in the range 0 to 1020 for encoding T1 and any value in the range 0 to 4095 for encoding T2.

————— **Note** —————

It is recommended that the alternative syntax form is avoided where possible. However, the only possible syntax for encoding T2 with the U bit and all immediate bits zero is `LDR<c><q> <Rt>, [PC, #-0]`.

Operation

```
if ConditionPassed() then
    EncodingSpecificOperations();
    base = Align(PC,4);
    address = if add then (base + imm32) else (base - imm32);
    if t == 15 then
        if address<1:0> != '00' then UNPREDICTABLE;
        LoadWritePC(MemU[address,4]);
    else
        R[t] = MemU[address,4];
```

Exceptions

UsageFault, MemManage, BusFault.

A5.7.44 LDR (register)

Load Register (register) calculates an address from a base register value and an offset register value, loads a word from memory, and writes it to a register. The offset register value can be shifted left by 0, 1, 2, or 3 bits. See *Memory accesses* on page A5-13 for information about memory accesses.

The register loaded can be the PC. If it is, the word loaded for the PC is treated as an address or exception return value and a branch occurs. Bit[0] complies with the ARM architecture interworking rules for branches to Thumb state execution and must be 1. If bit[0] is 0, a UsageFault exception occurs.

Encoding

T1 LDR<c> <Rt>, [<Rn>, <Rm>]

15	14	13	12	11	10	9	8	7	6	5	4	3	2	1	0
0	1	0	1	1	0	0		Rm		Rn					Rt

```
t = UInt(Rt); n = UInt(Rn); m = UInt(Rm);
(shift_t, shift_n) = (SRTYPE_None, 0);
```

T2 LDR<c>.W <Rt>, [<Rn>, <Rm>{, LSL #<shift>}]

15	14	13	12	11	10	9	8	7	6	5	4	3	2	1	0	15	14	13	12	11	10	9	8	7	6	5	4	3	2	1	0
1	1	1	1	1	0	0	0	0	1	0	1		Rn				Rt	0	0	0	0	0	0	0	shift		Rm				

```
t = UInt(Rt); n = UInt(Rn); m = UInt(Rm);
(shift_t, shift_n) = (SRTYPE_LSL, UInt(shift));
if n == 15 then SEE LDR (literal) on page A5-105;
if BadReg(m) then UNPREDICTABLE;
if t == 15 && InITBlock() && !LastInITBlock() then UNPREDICTABLE;
```

Architecture versions

Encoding T1 All versions of the Thumb instruction set.

Encoding T2 All versions of the Thumb instruction set from Thumb-2 onwards.

Assembler syntax

```
LDR<c><q> <Rt>, [<Rn>, <Rm> {, LSL #<shift>}]
```

where:

- <c><q> See *Standard assembler syntax fields* on page A5-6.
- <Rt> Specifies the destination register. This register is allowed to be the SP. It is also allowed to be the PC, provided the instruction is either outside an IT block or the last instruction of an IT block. If it is the PC, it causes a branch to the address (data) loaded into the PC.
- <Rn> Specifies the register that contains the base value. This register is allowed to be the SP.
- <Rm> Contains the offset that is shifted left and added to the value of <Rn> to form the address.
- <shift> Specifies the number of bits the value from <Rm> is shifted left, in the range 0-3. If this option is omitted, a shift by 0 is assumed and both encodings are permitted. If this option is specified, only encoding T2 is permitted.

Operation

```
if ConditionPassed() then
    EncodingSpecificOperations();
    address = R[n] + LSL(R[m], shift_n);
    if t == 15 then
        if address<1:0> != '00' then UNPREDICTABLE;
        LoadWritePC(MemU[address,4]);
    else
        R[t] = MemU[address,4];
```

Exceptions

UsageFault, MemManage, BusFault.

A5.7.45 LDRB (immediate)

Load Register Byte (immediate) calculates an address from a base register value and an immediate offset, loads a byte from memory, zero-extends it to form a 32-bit word, and writes it to a register. It can use offset, post-indexed, or pre-indexed addressing. See *Memory accesses* on page A5-13 for information about memory accesses.

Encoding

T1 LDRB<c> <Rt>, [<Rn>, #<imm>]

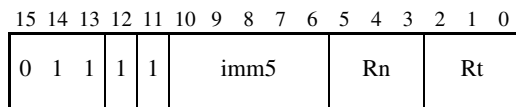

```
t = UInt(Rt); n = UInt(Rn); imm32 = ZeroExtend(imm5, 32);
index = TRUE; add = TRUE; wback = FALSE;
```

T2 LDRB<c>.W <Rt>, [<Rn>, #<imm12>]

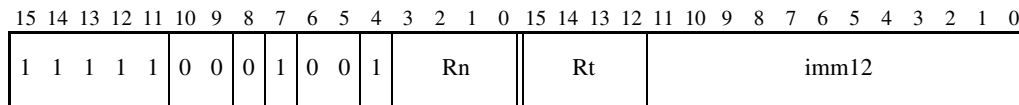

```
t = UInt(Rt); n = UInt(Rn); imm32 = ZeroExtend(imm12, 32);
index = TRUE; add = TRUE; wback = FALSE;
if t == 15 then SEE PLD (immediate) on page A5-198;
if n == 15 then SEE LDRB (literal) on page A5-111;
if t == 13 then UNPREDICTABLE;
```

T3 LDRB<c> <Rt>, [<Rn>, #-<imm8>]

LDRB<c> <Rt>, [<Rn>], #+/-<imm8>

LDRB<c> <Rt>, [<Rn>, #+/-<imm8>]!

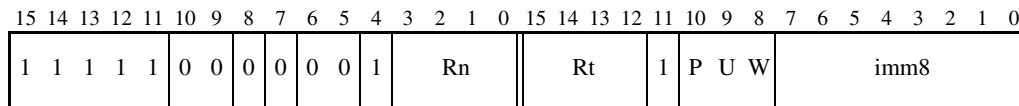

```
t = UInt(Rt); n = UInt(Rn); imm32 = ZeroExtend(imm8, 32);
index = (P == '1'); add = (U == '1'); wback = (W == '1');
if n == 15 then SEE LDRB (literal) on page A5-111;
if t == 15 && P == '1' && U == '0' && W == '0' then
    SEE PLD (immediate) on page A5-198;
if P == '1' && U == '1' && W == '0' then SEE LDRBT on page A5-115;
if P == '0' && W == '0' then UNDEFINED;
if BadReg(t) || (wback && n == t) then UNPREDICTABLE;
```

Architecture versions

Encodings T1 All versions of the Thumb instruction set.

Encodings T2, T3 All versions of the Thumb instruction set from Thumb-2 onwards.

Assembler syntax

```
LDRB<c><q> <Rt>, [<Rn> {, #+/-<imm>}]      Offset: index==TRUE, wback==FALSE
LDRB<c><q> <Rt>, [<Rn>, #+/-<imm>]!        Pre-indexed: index==TRUE, wback==TRUE
LDRB<c><q> <Rt>, [<Rn>], #+/-<imm>        Post-indexed: index==FALSE, wback==TRUE
```

where:

<c><q> See *Standard assembler syntax fields* on page A5-6.

<Rt> Specifies the destination register.

<Rn> Specifies the base register. This register is allowed to be the SP. If this register is the PC, see *LDRB (literal)* on page A5-111.

+/- Is + or omitted to indicate that the immediate offset is added to the base register value (add == TRUE), or - to indicate that the offset is to be subtracted (add == FALSE). Different instructions are generated for #0 and #-0.

<imm> Specifies the immediate offset added to or subtracted from the value of <Rn> to form the address. The range of allowed values is 0-31 for encoding T1, 0-4095 for encoding T2, and 0-255 for encoding T3. For the offset addressing syntax, <imm> can be omitted, meaning an offset of 0.

The pre-UAL syntax LDR<c>B is equivalent to LDRB<c>.

Operation

```
if ConditionPassed() then
    EncodingSpecificOperations();
    offset_addr = if add then (R[n] + imm32) else (R[n] - imm32);
    address = if index then offset_addr else R[n];
    if wback then R[n] = offset_addr;
    R[t] = ZeroExtend(MemU[address,1], 32);
```

Exceptions

MemManage, BusFault.

A5.7.46 LDRB (literal)

Load Register Byte (literal) calculates an address from the PC value and an immediate offset, loads a byte from memory, zero-extends it to form a 32-bit word, and writes it to a register. See *Memory accesses* on page A5-13 for information about memory accesses.

Encoding

T1 LDRB<c> <Rt>, [PC, #+/-<imm12>]

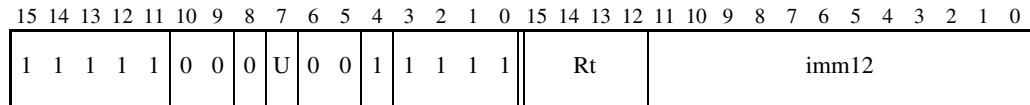

```
t = UInt(Rt); imm32 = ZeroExtend(imm12, 32); add = (U == '1');
if t == 15 then SEE PLD (immediate) on page A5-198;
if t == 13 then UNPREDICTABLE;
```

Architecture versions

Encoding T1 All versions of the Thumb instruction set from Thumb-2 onwards.

Assembler syntax

LDRB<c><q> <Rt>, <label> Normal form
 LDRB<c><q> <Rt>, [PC, #+/-<imm>] Alternative form

where:

<c><q> See *Standard assembler syntax fields* on page A5-6.

<Rt> Specifies the destination register.

<label> Specifies the label of the literal data item that is to be loaded into <Rt>. The assembler calculates the required value of the offset from the `Align(PC, 4)` value of this instruction to the label.

If the offset is positive, encoding T1 is permitted with `imm32` equal to the offset and `add == TRUE`. Allowed values of the offset are 0 to 4095.

If the offset is negative, encoding T1 is permitted with `imm32` equal to minus the offset and `add == FALSE`. Allowed values of the offset are -4095 to -1.

In the alternative syntax form:

+/- Is + or omitted to indicate that the immediate offset is added to the `Align(PC, 4)` value (`add == TRUE`), or - to indicate that the offset is to be subtracted (`add == FALSE`). Different instructions are generated for #0 and #-0.

<imm> Specifies the immediate offset added to or subtracted from the `Align(PC, 4)` value of the instruction to form the address.

Allowed values are 0 to 4095.

———— **Note** ————

It is recommended that the alternative syntax form is avoided where possible. However, the only possible syntax for encoding T1 with the U bit and all immediate bits zero is `LDRB<c><q> <Rt>, [PC, #-0]`.

The pre-UAL syntax `LDR<c>B` is equivalent to `LDRB<c>`.

Operation

```
if ConditionPassed() then
    EncodingSpecificOperations();
    base = Align(PC, 4);
    address = if add then (base + imm32) else (base - imm32);
    R[t] = ZeroExtend(MemU[address, 1], 32);
```

Exceptions

MemManage, BusFault.

A5.7.47 LDRB (register)

Load Register Byte (register) calculates an address from a base register value and an offset register value, loads a byte from memory, zero-extends it to form a 32-bit word, and writes it to a register. The offset register value can be shifted left by 0, 1, 2, or 3 bits. See *Memory accesses* on page A5-13 for information about memory accesses.

Encoding

T1 LDRB<c> <Rt>, [<Rn>, <Rm>]

15	14	13	12	11	10	9	8	7	6	5	4	3	2	1	0
0	1	0	1	1	1	0		Rm		Rn					Rt

```
t = UInt(Rt); n = UInt(Rn); m = UInt(Rm);
(shift_t, shift_n) = (SRTYPE_None, 0);
```

T2 LDRB<c>.W <Rt>, [<Rn>, <Rm>{, LSL #<shift>}]

15	14	13	12	11	10	9	8	7	6	5	4	3	2	1	0	15	14	13	12	11	10	9	8	7	6	5	4	3	2	1	0
1	1	1	1	1	0	0	0	0	0	0	1		Rn						Rt		0	0	0	0	0	0	shift	Rm			

```
t = UInt(Rt); n = UInt(Rn); m = UInt(Rm);
(shift_t, shift_n) = (SRTYPE_LSL, UInt(shift));
if t == 15 then SEE PLD (register) on page A5-200;
if n == 15 then SEE LDRB (literal) on page A5-111;
if t == 13 || BadReg(m) then UNPREDICTABLE;
```

Architecture versions

Encoding T1 All versions of the Thumb instruction set.

Encoding T2 All versions of the Thumb instruction set from Thumb-2 onwards.

Assembler syntax

```
LDRB<c><q> <Rt>, [<Rn>, <Rm> {, LSL #<shift>}]
```

where:

- <c><q> See *Standard assembler syntax fields* on page A5-6.
- <Rn> Specifies the register that contains the base value. This register is allowed to be the SP.
- <Rm> Contains the offset that is shifted left and added to the value of <Rn> to form the address.
- <shift> Specifies the number of bits the value from <Rm> is shifted left, in the range 0-3. If this option is omitted, a shift by 0 is assumed and both encodings are permitted. If this option is specified, only encoding T2 is permitted.

The pre-UAL syntax LDR<c>B is equivalent to LDRB<c>.

Operation

```
if ConditionPassed() then
    EncodingSpecificOperations();
    address = R[n] + LSL(R[m], shift_n);
    R[t] = ZeroExtend(MemU[address,1], 32);
```

Exceptions

MemManage, BusFault.

A5.7.48 LDRBT

Load Register Byte Unprivileged calculates an address from a base register value and an immediate offset, loads a byte from memory, zero-extends it to form a 32-bit word, and writes it to a register. See *Memory accesses* on page A5-13 for information about memory accesses.

The memory access is restricted as if the processor were running unprivileged. (This makes no difference if the processor is actually running unprivileged.)

Encoding

T1 LDRBT<c> <Rt>, [<Rn>, #<imm8>]

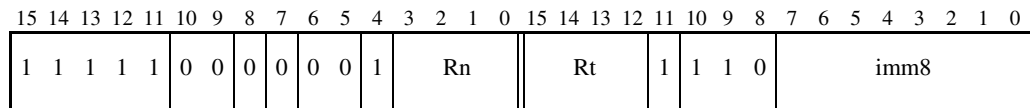

```
t = UInt(Rt); n = UInt(Rn); imm32 = ZeroExtend(imm8, 32);
if n == 15 then SEE LDRB (literal) on page A5-111;
if BadReg(t) then UNPREDICTABLE;
```

Architecture versions

Encoding T1 All versions of the Thumb instruction set from Thumb-2 onwards.

Assembler syntax

```
LDRBT<c><q> <Rt>, [<Rn> {, #<imm>}]
```

where:

- <c><q> See *Standard assembler syntax fields* on page A5-6.
- <Rt> Specifies the destination register.
- <Rn> Specifies the base register. This register is allowed to be the SP.
- <imm> Specifies the immediate offset added to the value of <Rn> to form the address. The range of allowed values is 0-255. <imm> can be omitted, meaning an offset of 0.

The pre-UAL syntax LDR<c>BT is equivalent to LDRBT<c>.

Operation

```
if ConditionPassed() then
    EncodingSpecificOperations();
    address = R[n] + imm32;
    R[t] = ZeroExtend(MemU_unpriv[address, 1], 32);
```

Exceptions

MemManage, BusFault.

A5.7.49 LDRD (immediate)

Load Register Dual (immediate) calculates an address from a base register value and an immediate offset, loads two words from memory, and writes them to two registers. It can use offset, post-indexed, or pre-indexed addressing. See *Memory accesses* on page A5-13 for information about memory accesses.

Encoding

T1 LDRD<c> <Rt>, <Rt2>, [<Rn>, #+/-<imm>]{!}
 LDRD<c> <Rt>, <Rt2>, [<Rn>], #+/-<imm>

15	14	13	12	11	10	9	8	7	6	5	4	3	2	1	0	15	14	13	12	11	10	9	8	7	6	5	4	3	2	1	0
1	1	1	0	1	0	0	P	U	1	W	1	Rn				Rt				Rt2				imm8							

```
t = UInt(Rt);  t2 = UInt(Rt2);  n = UInt(Rn);
imm32 = ZeroExtend(imm8:'00', 32);
index = (P == '1');  add = (U == '1');  wback = (W == '1');
if P == '0' && W == '0' then
    SEE Load/store double and exclusive, and table branch on page A4-27;
if wback && n == 15 then UNPREDICTABLE;
if BadReg(t) || BadReg(t2) || t1 == t2 then UNPREDICTABLE;
```

Architecture versions

Encoding T1 All versions of the Thumb instruction set from Thumb-2 onwards.

Assembler syntax

```
LDRD<c><q> <Rt>, <Rt2>, [<Rn>{, #+/-<imm>}] Offset: index==TRUE, wback==FALSE
LDRD<c><q> <Rt>, <Rt2>, [<Rn>, #+/-<imm>! Pre-indexed: index==TRUE, wback==TRUE
LDRD<c><q> <Rt>, <Rt2>, [<Rn>], #+/-<imm> Post-indexed: index==FALSE, wback==TRUE
```

where:

<c><q> See *Standard assembler syntax fields* on page A5-6.

<Rt> Specifies the first destination register.

<Rt2> Specifies the second destination register.

<Rn> Specifies the base register. This register is allowed to be the SP. In the offset addressing form of the syntax, it is also allowed to be the PC.

+/- Is + or omitted to indicate that the immediate offset is added to the base register value (`add == TRUE`), or - to indicate that the offset is to be subtracted (`add == FALSE`). Different instructions are generated for #0 and #-0.

<imm> Specifies the immediate offset added to or subtracted from the value of <Rn> to form the address. Allowed values are multiples of 4 in the range 0-1020. For the offset addressing syntax, <imm> can be omitted, meaning an offset of 0.

The pre-UAL syntax `LDR<c>D` is equivalent to `LDRD<c>`.

Operation

```
if ConditionPassed() then
    EncodingSpecificOperations();
    base = if n == 15 then Align(PC,4) else R[n];
    offset_addr = if add then (base + imm32) else (base - imm32);
    address = if index then offset_addr else R[n];
    if wback then R[n] = offset_addr;
    R[t] = MemA[address,4];
    R[t2] = MemA[address+4,4];
```

Exceptions

UsageFault, MemManage, BusFault.

A5.7.50 LDREX

Load Register Exclusive calculates an address from a base register value and an immediate offset, loads a word from memory, writes it to a register and:

- if the address has the Shared Memory attribute, marks the physical address as exclusive access for the executing processor in a shared monitor
- causes the executing processor to indicate an active exclusive access in the local monitor.

See *Memory accesses* on page A5-13 for information about memory accesses.

Encoding

T1 LDREX<c> <Rt>, [<Rn>{, #<imm>}]

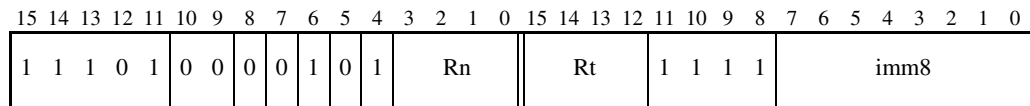

```
t = UInt(Rt); n = UInt(Rn); imm32 = ZeroExtend(imm8:'00', 32);
if BadReg(t) || n == 15 then UNPREDICTABLE;
```

Architecture versions

Encoding T1 All versions of the Thumb instruction set from Thumb-2 onwards.

Assembler syntax

```
LDREX<c><q> <Rt>, [<Rn> {, #<imm>}]
```

where:

- <c><q> See *Standard assembler syntax fields* on page A5-6.
- <Rt> Specifies the destination register.
- <Rn> Specifies the base register. This register is allowed to be the SP.
- <imm> Specifies the immediate offset added to the value of <Rn> to form the address. Allowed values are multiples of 4 in the range 0-1020. <imm> can be omitted, meaning an offset of 0.

Operation

```
if ConditionPassed() then
    EncodingSpecificOperations();
    address = R[n] + imm32;
    SetExclusiveMonitors(address, 4);
    R[t] = MemAA[address, 4];
```

Exceptions

UsageFault, MemManage, BusFault.

A5.7.51 LDREXB

Load Register Exclusive Byte derives an address from a base register value, loads a byte from memory, zero-extends it to form a 32-bit word, writes it to a register and:

- if the address has the Shared Memory attribute, marks the physical address as exclusive access for the executing processor in a shared monitor
- causes the executing processor to indicate an active exclusive access in the local monitor.

See *Memory accesses* on page A5-13 for information about memory accesses.

Encoding

T1 LDREXB<c> <Rt>, [<Rn>]

15	14	13	12	11	10	9	8	7	6	5	4	3	2	1	0	15	14	13	12	11	10	9	8	7	6	5	4	3	2	1	0
1	1	1	0	1	0	0	0	1	1	0	1	Rn				Rt				(1)	(1)	(1)	(1)	0	1	0	0	(1)	(1)	(1)	(1)

```
t = UInt(Rt); n = UInt(Rn);
if BadReg(t) || n == 15 then UNPREDICTABLE;
```

Architecture versions

Encoding T1 All versions of the Thumb instruction set from v6K onwards.

Assembler syntax

```
LDREXB<c><q> <Rt>, [<Rn>]
```

where:

- <c><q> See *Standard assembler syntax fields* on page A5-6.
- <Rt> Specifies the destination register.
- <Rn> Specifies the base register. This register is allowed to be the SP.

Operation

```
if ConditionPassed() then
    EncodingSpecificOperations();
    address = R[n];
    SetExclusiveMonitors(address,1);
    R[t] = MemAA[address,1];
```

Exceptions

MemManage, BusFault.

A5.7.52 LDREXH

Load Register Exclusive Halfword derives an address from a base register value, loads a halfword from memory, zero-extends it to form a 32-bit word, writes it to a register and:

- if the address has the Shared Memory attribute, marks the physical address as exclusive access for the executing processor in a shared monitor
- causes the executing processor to indicate an active exclusive access in the local monitor.

See *Memory accesses* on page A5-13 for information about memory accesses.

Encoding

T1 LDREXH<c> <Rt>, [<Rn>]

15	14	13	12	11	10	9	8	7	6	5	4	3	2	1	0	15	14	13	12	11	10	9	8	7	6	5	4	3	2	1	0
1	1	1	0	1	0	0	0	1	1	0	1	Rn				Rt				(1)	(1)	(1)	(1)	0	1	0	1	(1)	(1)	(1)	(1)

```
t = UInt(Rt); n = UInt(Rn);
if BadReg(t) || n == 15 then UNPREDICTABLE;
```

Architecture versions

Encoding T1 All versions of the Thumb instruction set from v6K onwards.

Assembler syntax

LDREXH<c><q> <Rt>, [<Rn>]

where:

<c><q> See *Standard assembler syntax fields* on page A5-6.

<Rt> Specifies the destination register.

<Rn> Specifies the base register. This register is allowed to be the SP.

Operation

```
if ConditionPassed() then
    EncodingSpecificOperations();
    address = R[n];
    SetExclusiveMonitors(address, 2);
    R[t] = MemAA[address, 2];
```

Exceptions

UsageFault, MemManage, BusFault.

A5.7.53 LDRH (immediate)

Load Register Halfword (immediate) calculates an address from a base register value and an immediate offset, loads a halfword from memory, zero-extends it to form a 32-bit word, and writes it to a register. It can use offset, post-indexed, or pre-indexed addressing. See *Memory accesses* on page A5-13 for information about memory accesses.

Encoding

T1 LDRH<c> <Rt>, [<Rn>, #<imm>]

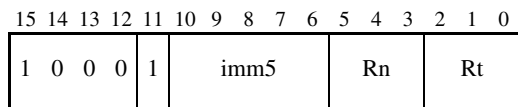

```
t = UInt(Rt); n = UInt(Rn); imm32 = ZeroExtend(imm5:'0', 32);
index = TRUE; add = TRUE; wback = FALSE;
```

T2 LDRH<c>.W <Rt>, [<Rn>, #<imm12>]

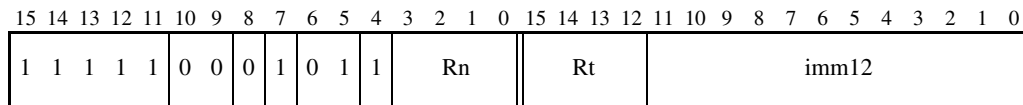

```
t = UInt(Rt); n = UInt(Rn); imm32 = ZeroExtend(imm12, 32);
index = TRUE; add = TRUE; wback = FALSE;
if n == 15 then SEE LDRH (literal) on page A5-127;
if t == 15 then SEE Memory hints on page A5-14
if t == 13 then UNPREDICTABLE;
```

T3 LDRH<c> <Rt>, [<Rn>, #-<imm8>]

LDRH<c> <Rt>, [<Rn>], #+/-<imm8>

LDRH<c> <Rt>, [<Rn>, #+/-<imm8>!]

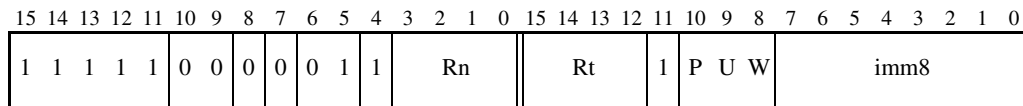

```
t = UInt(Rt); n = UInt(Rn); imm32 = ZeroExtend(imm8, 32);
index = (P == '1'); add = (U == '1'); wback = (W == '1');
if n == 15 then SEE LDRH (literal) on page A5-127;
if t == 15 && P == '1' && U == '0' && W == '0' then
    SEE Memory hints on page A5-14
if P == '1' && U == '1' && W == '0' then SEE LDRHT on page A5-131;
if P == '0' && W == '0' then UNDEFINED;
if BadReg(t) || (wback && n == t) then UNPREDICTABLE;
```

Architecture versions

Encodings T1, T2 All versions of the Thumb instruction set.

Encodings T3, T4 All versions of the Thumb instruction set from Thumb-2 onwards.

Assembler syntax

```
LDRH<c><q> <Rt>, [<Rn> {, #+/-<imm>}]      Offset: index==TRUE, wback==FALSE
LDRH<c><q> <Rt>, [<Rn>, #+/-<imm>]!        Pre-indexed: index==TRUE, wback==TRUE
LDRH<c><q> <Rt>, [<Rn>], #+/-<imm>        Post-indexed: index==FALSE, wback==TRUE
```

where:

<c><q> See *Standard assembler syntax fields* on page A5-6.

<Rt> Specifies the destination register.

<Rn> Specifies the base register. This register is allowed to be the SP. If this register is the PC, see *LDRH (literal)* on page A5-127.

+/- Is + or omitted to indicate that the immediate offset is added to the base register value (`add == TRUE`), or - to indicate that the offset is to be subtracted (`add == FALSE`). Different instructions are generated for #0 and #-0.

<imm> Specifies the immediate offset added to or subtracted from the value of <Rn> to form the address. Allowed values are multiples of 2 in the range 0-62 for encoding T1, any value in the range 0-4095 for encoding T2, and any value in the range 0-255 for encoding T3. For the offset addressing syntax, <imm> can be omitted, meaning an offset of 0.

The pre-UAL syntax `LDR<c>H` is equivalent to `LDRH<c>`.

Operation

```
if ConditionPassed() then
    EncodingSpecificOperations();
    offset_addr = if add then (R[n] + imm32) else (R[n] - imm32);
    address = if index then offset_addr else R[n];
    if wback then R[n] = offset_addr;
    R[t] = ZeroExtend(MemU[address, 2], 32);
```

Exceptions

UsageFault, MemManage, BusFault.

A5.7.54 LDRH (literal)

Load Register Halfword (literal) calculates an address from the PC value and an immediate offset, loads a halfword from memory, zero-extends it to form a 32-bit word, and writes it to a register. See *Memory accesses* on page A5-13 for information about memory accesses.

Encoding

T1 LDRH<c> <Rt>, [PC, #+/-<imm12>]

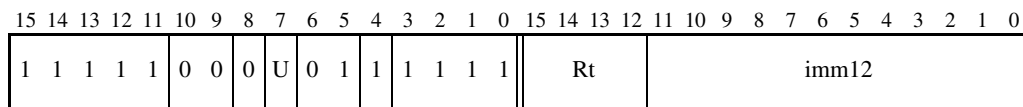

```
t = UInt(Rt); imm32 = ZeroExtend(imm12, 32); add = (U == '1');
if t == 15 then SEE Memory hints on page A5-14;
if t == 13 then UNPREDICTABLE;
```

Architecture versions

Encoding T1 All versions of the Thumb instruction set from Thumb-2 onwards.

Assembler syntax

LDRH<c><q> <Rt>, <label> Normal form
 LDRH<c><q> <Rt>, [PC, #+/-<imm>] Alternative form

where:

<c><q> See *Standard assembler syntax fields* on page A5-6.

<Rd> Specifies the destination register.

<label> Specifies the label of the literal data item that is to be loaded into <Rt>. The assembler calculates the required value of the offset from the `Align(PC, 4)` value of the ADR instruction to this label.

If the offset is positive, encoding T1 is permitted with `imm32` equal to the offset and `add == TRUE`. Allowed values of the offset are 0 to 4095.

If the offset is negative, encoding T1 is permitted with `imm32` equal to minus the offset and `add == FALSE`. Allowed values of the offset are -4095 to -1.

In the alternative syntax form:

+/- Is + or omitted to indicate that the immediate offset is added to the `Align(PC, 4)` value (`add == TRUE`), or - to indicate that the offset is to be subtracted (`add == FALSE`). Different instructions are generated for #0 and #-0.

<imm> Specifies the immediate offset added to or subtracted from the `Align(PC, 4)` value of the instruction to form the address. Allowed values are 0 to 4095.

————— **Note** —————

It is recommended that the alternative syntax forms are avoided where possible. However, the only possible syntax for encoding T1 with the U bit and all immediate bits zero is `LDRH<c><q> <Rt>, [PC, #0]`.

—————

The pre-UAL syntax `LDR<c>H` is equivalent to `LDRH<c>`.

Operation

```
if ConditionPassed() then
    EncodingSpecificOperations();
    base = Align(PC, 4);
    address = if add then (base + imm32) else (base - imm32);
    R[t] = ZeroExtend(MemU[address, 2], 32);
```

Exceptions

UsageFault, MemManage, BusFault.

A5.7.55 LDRH (register)

Load Register Halfword (register) calculates an address from a base register value and an offset register value, loads a halfword from memory, zero-extends it to form a 32-bit word, and writes it to a register. The offset register value can be shifted left by 0, 1, 2, or 3 bits. See *Memory accesses* on page A5-13 for information about memory accesses.

Encoding

T1 LDRH<c> <Rt>, [<Rn>, <Rm>]

15	14	13	12	11	10	9	8	7	6	5	4	3	2	1	0
0	1	0	1	1	0	1	Rm	Rn	Rt						

```
t = UInt(Rt); n = UInt(Rn); m = UInt(Rm);
(shift_t, shift_n) = (SRTYPE_None, 0);
```

T2 LDRH<c>.W <Rt>, [<Rn>, <Rm>{, LSL #<shift>}]

15	14	13	12	11	10	9	8	7	6	5	4	3	2	1	0	15	14	13	12	11	10	9	8	7	6	5	4	3	2	1	0
1	1	1	1	1	0	0	0	0	0	1	1	Rn	Rt	0	0	0	0	0	0	0	shift	Rm									

```
t = UInt(Rt); n = UInt(Rn); m = UInt(Rm);
(shift_t, shift_n) = (SRTYPE_LSL, UInt(shift));
if n == 15 then SEE LDRH (literal) on page A5-127;
if t == 15 then SEE Memory hints on page A5-14;
if t == 13 || BadReg(m) then UNPREDICTABLE;;
```

Architecture versions

Encoding T1 All versions of the Thumb instruction set.

Encoding T2 All versions of the Thumb instruction set from Thumb-2 onwards.

Assembler syntax

```
LDRH<c><q> <Rt>, [<Rn>, <Rm> {, LSL #<shift>}]
```

where:

- <c><q> See *Standard assembler syntax fields* on page A5-6.
- <Rn> Specifies the register that contains the base value. This register is allowed to be the SP.
- <Rm> Contains the offset that is shifted left and added to the value of <Rn> to form the address.
- <shift> Specifies the number of bits the value from <Rm> is shifted left, in the range 0-3. If this option is omitted, a shift by 0 is assumed and both encodings are permitted. If this option is specified, only encoding T2 is permitted.

The pre-UAL syntax LDR<c>H is equivalent to LDRH<c>.

Operation

```
if ConditionPassed() then
    EncodingSpecificOperations();
    address = R[n] + LSL(R[m], shift_n);
    R[t] = ZeroExtend(MemU[address, 2], 32);
```

Exceptions

UsageFault, MemManage, BusFault.

A5.7.56 LDRHT

Load Register Halfword Unprivileged calculates an address from a base register value and an immediate offset, loads a halfword from memory, zero-extends it to form a 32-bit word, and writes it to a register. See *Memory accesses* on page A5-13 for information about memory accesses.

The memory access is restricted as if the processor were running unprivileged. (This makes no difference if the processor is actually running unprivileged.)

Encoding

T1 LDRHT<c> <Rt>, [<Rn>, #<imm8>]

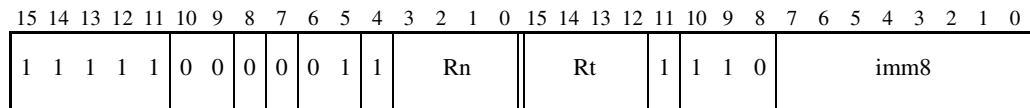

```
t = UInt(Rt); n = UInt(Rn); imm32 = ZeroExtend(imm8, 32);
if n == 15 then SEE LDRH (literal) on page A5-127;
if BadReg(t) then UNPREDICTABLE;
```

Architecture versions

Encoding T1 All versions of the Thumb instruction set from Thumb-2 onwards.

Assembler syntax

```
LDRHT<c><q> <Rt>, [<Rn> {, #<imm>}]
```

where:

- <c><q> See *Standard assembler syntax fields* on page A5-6.
- <Rt> Specifies the destination register.
- <Rn> Specifies the base register. This register is allowed to be the SP.
- <imm> Specifies the immediate offset added to the value of <Rn> to form the address. The range of allowed values is 0-255. <imm> can be omitted, meaning an offset of 0.

Operation

```
if ConditionPassed() then
    EncodingSpecificOperations();
    address = R[n] + imm32;
    R[t] = ZeroExtend(MemU_unpriv[address, 2], 32);
```

Exceptions

UsageFault, MemManage, BusFault.

A5.7.57 LDRSB (immediate)

Load Register Signed Byte (immediate) calculates an address from a base register value and an immediate offset, loads a byte from memory, sign-extends it to form a 32-bit word, and writes it to a register. It can use offset, post-indexed, or pre-indexed addressing. See *Memory accesses* on page A5-13 for information about memory accesses.

Encoding

T1 LDRSB<c> <Rt>, [<Rn>, #<imm12>]

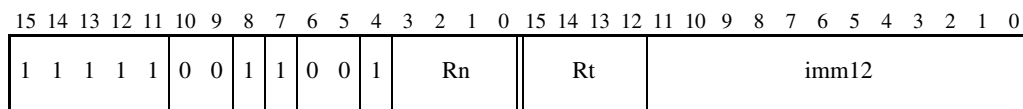

```
t = UInt(Rt); n = UInt(Rn); imm32 = ZeroExtend(imm12, 32); index = TRUE;
add = TRUE; wback = FALSE;
if t == 15 then SEE PLI (immediate) on page A5-202;
if n == 15 then SEE LDRSB (literal) on page A5-135;
if t == 13 then UNPREDICTABLE;
```

T2 LDRSB<c> <Rt>, [<Rn>, #-<imm8>]
 LDRSB<c> <Rt>, [<Rn>], #+/-<imm8>
 LDRSB<c> <Rt>, [<Rn>, #+/-<imm8>!]

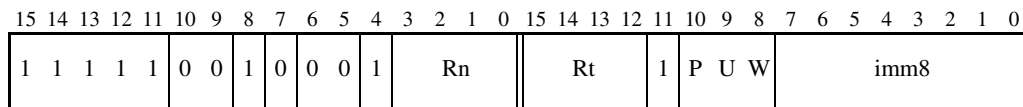

```
t = UInt(Rt); n = UInt(Rn); imm32 = ZeroExtend(imm8, 32); index = (P == '1');
add = (U == '1'); wback = (W == '1');
if n == 15 then SEE LDRSB (literal) on page A5-135;
if t == 15 && P == '1' && U == '0' && W == '0' then
    SEE PLI (immediate) on page A5-202;
if P == '1' && U == '1' && W == '0' then SEE LDRSBT on page A5-139;
if P == '0' && W == '0' then UNDEFINED;
if BadReg(t) || (wback && n == t) then UNPREDICTABLE;
```

Architecture versions

Encodings T1, T2 All versions of the Thumb instruction set from Thumb-2 onwards.

Assembler syntax

`LDRSB<c><q> <Rt>, [<Rn> {, #+/-<imm>}]` Offset: `index==TRUE, wback==FALSE`
`LDRSB<c><q> <Rt>, [<Rn>, #+/-<imm>]!` Pre-indexed: `index==TRUE, wback==TRUE`
`LDRSB<c><q> <Rt>, [<Rn>], #+/-<imm>` Post-indexed: `index==FALSE, wback==TRUE`

where:

`<c><q>` See *Standard assembler syntax fields* on page A5-6.
`<Rt>` Specifies the destination register.
`<Rn>` Specifies the base register. This register is allowed to be the SP. If this register is the PC, see *LDRSB (literal)* on page A5-135.
`+/-` Is + or omitted to indicate that the immediate offset is added to the base register value (`add == TRUE`), or - to indicate that the offset is to be subtracted (`add == FALSE`). Different instructions are generated for #0 and #-0.
`<imm>` Specifies the immediate offset added to or subtracted from the value of `<Rn>` to form the address. The range of allowed values is 0-4095 for encoding T1, and 0-255 for encoding T2. For the offset addressing syntax, `<imm>` can be omitted, meaning an offset of 0.

The pre-UAL syntax `LDR<c>SB` is equivalent to `LDRSB<c>`.

Operation

```

if ConditionPassed() then
    EncodingSpecificOperations();
    offset_addr = if add then (R[n] + imm32) else (R[n] - imm32);
    address = if index then offset_addr else R[n];
    if wback then R[n] = offset_addr;
    R[t] = SignExtend(MemU[address,1], 32);
  
```

Exceptions

MemManage, BusFault.

A5.7.58 LDRSB (literal)

Load Register Signed Byte (literal) calculates an address from the PC value and an immediate offset, loads a byte from memory, sign-extends it to form a 32-bit word, and writes it to a register. See *Memory accesses* on page A5-13 for information about memory accesses.

Encoding

T1 LDRSB<c> <Rt>, [PC, #+/-<imm12>]

15	14	13	12	11	10	9	8	7	6	5	4	3	2	1	0	15	14	13	12	11	10	9	8	7	6	5	4	3	2	1	0
1	1	1	1	1	0	0	1	U	0	0	1	1	1	1	1	Rt	imm12														

```
t = UInt(Rt); imm32 = ZeroExtend(imm12, 32); add = (U == '1');
if t == 15 then SEE PLI (immediate) on page A5-202;
if t == 13 then UNPREDICTABLE;
```

Architecture versions

Encoding T1 All versions of the Thumb instruction set from Thumb-2 onwards.

Assembler syntax

LDRSB<c><q> <Rt>, <label> Normal form
 LDRSB<c><q> <Rt>, [PC, #+/-<imm>] Alternative form

where:

<c><q> See *Standard assembler syntax fields* on page A5-6.

<Rd> Specifies the destination register.

<label> Specifies the label of the literal data item that is to be loaded into <Rt>. The assembler calculates the required value of the offset from the `Align(PC, 4)` value of the ADR instruction to this label.

If the offset is positive, encoding T1 is permitted with `imm32` equal to the offset and `add == TRUE`. Allowed values of the offset are 0 to 4095.

If the offset is negative, encoding T1 is permitted with `imm32` equal to minus the offset and `add == FALSE`. Allowed values of the offset are -4095 to -1.

In the alternative syntax form:

+/- Is + or omitted to indicate that the immediate offset is added to the `Align(PC, 4)` value (`add == TRUE`), or - to indicate that the offset is to be subtracted (`add == FALSE`). Different instructions are generated for #0 and #-0.

<imm> Specifies the immediate offset added to or subtracted from the `Align(PC, 4)` value of the instruction to form the address. Allowed values are 0 to 4095.

————— **Note** —————

It is recommended that the alternative syntax forms are avoided where possible. However, the only possible syntax for encoding T1 with the U bit and all immediate bits zero is `LDRSB<c><q> <Rt>, [PC, #0]`.

The pre-UAL syntax `LDR<c>SB` is equivalent to `LDRSB<c>`.

Operation

```
if ConditionPassed() then
    EncodingSpecificOperations();
    base = Align(PC, 4);
    address = if add then (base + imm32) else (base - imm32);
    R[t] = SignExtend(MemU[address, 1], 32);
```

Exceptions

MemManage, BusFault.

A5.7.59 LDRSB (register)

Load Register Signed Byte (register) calculates an address from a base register value and an offset register value, loads a byte from memory, sign-extends it to form a 32-bit word, and writes it to a register. The offset register value can be shifted left by 0, 1, 2, or 3 bits. See *Memory accesses* on page A5-13 for information about memory accesses.

Encoding

T1 LDRSB<c> <Rt>, [<Rn>, <Rm>]

15	14	13	12	11	10	9	8	7	6	5	4	3	2	1	0
0	1	0	1	0	1	1	Rm			Rn			Rt		

```
t = UInt(Rt); n = UInt(Rn); m = UInt(Rm);
(shift_t, shift_n) = (SRTYPE_None, 0);
```

T2 LDRSB<c>.W <Rt>, [<Rn>, <Rm>{, LSL #<shift>}]

15	14	13	12	11	10	9	8	7	6	5	4	3	2	1	0	15	14	13	12	11	10	9	8	7	6	5	4	3	2	1	0
1	1	1	1	1	0	0	1	0	0	0	1	Rn			Rt			0	0 0 0 0 0				shift	Rm							

```
t = UInt(Rt); n = UInt(Rn); m = UInt(Rm);
(shift_t, shift_n) = (SRTYPE_LSL, UInt(shift));
if t == 15 then SEE PLI (register) on page A5-204;
if n == 15 then SEE LDRSB (literal) on page A5-135;
if t == 13 || BadReg(m) then UNPREDICTABLE;
```

Architecture versions

Encoding T1 All versions of the Thumb instruction set.

Encoding T2 All versions of the Thumb instruction set from Thumb-2 onwards.

Assembler syntax

```
LDRSB<c><q> <Rt>, [<Rn>, <Rm> {, LSL #<shift>}]
```

where:

- <c><q> See *Standard assembler syntax fields* on page A5-6.
- <Rn> Specifies the register that contains the base value. This register is allowed to be the SP.
- <Rm> Contains the offset that is shifted left and added to the value of <Rn> to form the address.
- <shift> Specifies the number of bits the value from <Rm> is shifted left, in the range 0-3. If this option is omitted, a shift by 0 is assumed and both encodings are permitted. If this option is specified, only encoding T2 is permitted.

The pre-UAL syntax LDR<c>SB is equivalent to LDRSB<c>.

Operation

```
if ConditionPassed() then
    EncodingSpecificOperations();
    address = R[n] + LSL(R[m], shift_n);
    R[t] = SignExtend(MemU[address,1], 32);
```

Exceptions

MemManage, BusFault.

A5.7.60 LDRSBT

Load Register Signed Byte Unprivileged calculates an address from a base register value and an immediate offset, loads a byte from memory, sign-extends it to form a 32-bit word, and writes it to a register. See *Memory accesses* on page A5-13 for information about memory accesses.

The memory access is restricted as if the processor were running unprivileged. (This makes no difference if the processor is actually running unprivileged.)

Encoding

T1 LDRSBT<c> <Rt>, [<Rn>, #<imm8>]

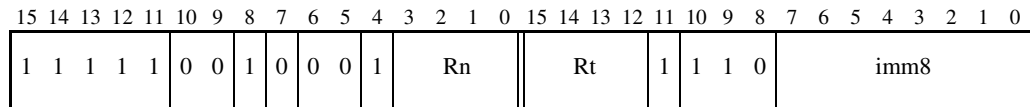

```
t = UInt(Rt); n = UInt(Rn); imm32 = ZeroExtend(imm8, 32);
if n == 15 then SEE LDRSB (literal) on page A5-135;
if BadReg(t) then UNPREDICTABLE;
```

Architecture versions

Encoding T1 All versions of the Thumb instruction set from Thumb-2 onwards.

Assembler syntax

```
LDRSBT<c><q> <Rt>, [<Rn> {, #<imm>}]
```

where:

- <c><q> See *Standard assembler syntax fields* on page A5-6.
- <Rt> Specifies the destination register.
- <Rn> Specifies the base register. This register is allowed to be the SP.
- <imm> Specifies the immediate offset added to the value of <Rn> to form the address. The range of allowed values is 0-255. <imm> can be omitted, meaning an offset of 0.

Operation

```
if ConditionPassed() then
    EncodingSpecificOperations();
    address = R[n] + imm32;
    R[t] = SignExtend(MemU_unpriv[address,1], 32);
```

Exceptions

MemManage, BusFault.

A5.7.61 LDRSH (immediate)

Load Register Signed Halfword (immediate) calculates an address from a base register value and an immediate offset, loads a halfword from memory, sign-extends it to form a 32-bit word, and writes it to a register. It can use offset, post-indexed, or pre-indexed addressing. See *Memory accesses* on page A5-13 for information about memory accesses.

Encoding

T1 LDRSH<c> <Rt>, [<Rn>, #<imm12>]

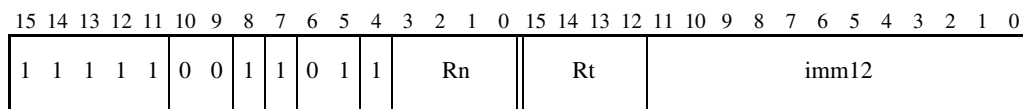

```
t = UInt(Rt); n = UInt(Rn); imm32 = ZeroExtend(imm12, 32);
index = TRUE; add = TRUE; wback = FALSE;
if n == 15 then SEE LDRSH (literal) on page A5-143;
if t == 15 then SEE Memory hints on page A5-14;
if t == 13 then UNPREDICTABLE;
```

T2 LDRSH<c> <Rt>, [<Rn>, #-<imm8>]
 LDRSH<c> <Rt>, [<Rn>], #+/-<imm8>
 LDRSH<c> <Rt>, [<Rn>, #+/-<imm8>]!

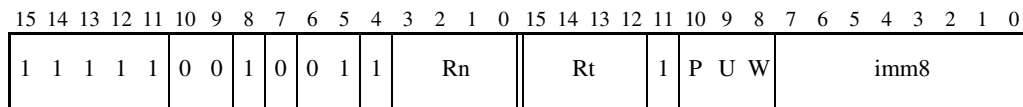

```
t = UInt(Rt); n = UInt(Rn); imm32 = ZeroExtend(imm8, 32);
index = (P == '1'); add = (U == '1'); wback = (W == '1');
if n == 15 then SEE LDRSH (literal) on page A5-143;
if t == 15 && P == '1' && U == '0' && W == '0' then
    SEE Memory hints on page A5-14;
if P == '1' && U == '1' && W == '0' then SEE LDRSHT on page A5-147;
if P == '0' && W == '0' then UNDEFINED;
if BadReg(t) || (wback && n == t) then UNPREDICTABLE;
```

Architecture versions

Encodings T1, T2 All versions of the Thumb instruction set from Thumb-2 onwards.

Assembler syntax

LDRSH<c><q> <Rt>, [<Rn> {, #+/-<imm>}] Offset: index==TRUE, wback==FALSE
 LDRSH<c><q> <Rt>, [<Rn>, #+/-<imm>]! Pre-indexed: index==TRUE, wback==TRUE
 LDRSH<c><q> <Rt>, [<Rn>], #+/-<imm> Post-indexed: index==FALSE, wback==TRUE

where:

<c><q> See *Standard assembler syntax fields* on page A5-6.

<Rt> Specifies the destination register.

<Rn> Specifies the base register. This register is allowed to be the SP. If this register is the PC, see *LDRSH (literal)* on page A5-143.

+/- Is + or omitted to indicate that the immediate offset is added to the base register value (add == TRUE), or – to indicate that the offset is to be subtracted (add == FALSE). Different instructions are generated for #0 and #-0.

<imm> Specifies the immediate offset added to or subtracted from the value of <Rn> to form the address. The range of allowed values is 0-4095 for encoding T1, and 0-255 for encoding T2. For the offset addressing syntax, <imm> can be omitted, meaning an offset of 0.

The pre-UAL syntax LDR<c>SH is equivalent to LDRSH<c>.

Operation

```
if ConditionPassed() then
    EncodingSpecificOperations();
    offset_addr = if add then (R[n] + imm32) else (R[n] - imm32);
    address = if index then offset_addr else R[n];
    if wback then R[n] = offset_addr;
    R[t] = SignExtend(MemU[address,2], 32);
```

Exceptions

UsageFault, MemManage, BusFault.

A5.7.62 LDRSH (literal)

Load Register Signed Halfword (literal) calculates an address from the PC value and an immediate offset, loads a halfword from memory, sign-extends it to form a 32-bit word, and writes it to a register. See *Memory accesses* on page A5-13 for information about memory accesses.

Encoding

T1 LDRSH<c> <Rt>, [PC, #+/-<imm12>]

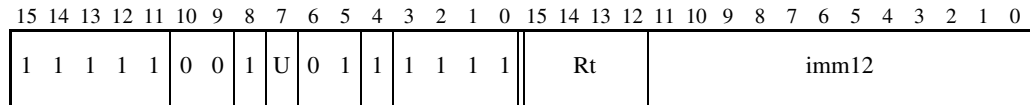

```
t = UInt(Rt); imm32 = ZeroExtend(imm12, 32); add = (U == '1');
if t == 15 then SEE Memory hints on page A5-14;
if t == 13 then UNPREDICTABLE;
```

Architecture versions

Encoding T1 All versions of the Thumb instruction set from Thumb-2 onwards.

Assembler syntax

LDRSH<c><q> <Rt>, <label> Normal form
 LDRSH<c><q> <Rt>, [PC, #+/-<imm>] Alternative form

where:

<c><q> See *Standard assembler syntax fields* on page A5-6.

<Rd> Specifies the destination register.

<label> Specifies the label of the literal data item that is to be loaded into <Rt>. The assembler calculates the required value of the offset from the `Align(PC, 4)` value of the ADR instruction to this label.

If the offset is positive, encoding T1 is permitted with `imm32` equal to the offset and `add == TRUE`. Allowed values of the offset are 0 to 4095.

If the offset is negative, encoding T1 is permitted with `imm32` equal to minus the offset and `add == FALSE`. Allowed values of the offset are -4095 to -1.

In the alternative syntax form:

+/- Is + or omitted to indicate that the immediate offset is added to the `Align(PC, 4)` value (`add == TRUE`), or - to indicate that the offset is to be subtracted (`add == FALSE`). Different instructions are generated for #0 and #-0.

<imm> Specifies the immediate offset added to or subtracted from the `Align(PC, 4)` value of the instruction to form the address. Allowed values are 0 to 4095.

Note

It is recommended that the alternative syntax forms are avoided where possible. However, the only possible syntax for encoding T1 with the U bit and all immediate bits zero is `LDRSH<c><q> <Rt>, [PC, #0]`.

The pre-UAL syntax `LDR<c>SH` is equivalent to `LDRSH<c>`.

Operation

```
if ConditionPassed() then
    EncodingSpecificOperations();
    base = Align(PC, 4);
    address = if add then (base + imm32) else (base - imm32);
    R[t] = SignExtend(MemU[address, 2], 32);
```

Exceptions

UsageFault, MemManage, BusFault.

A5.7.63 LDRSH (register)

Load Register Signed Halfword (register) calculates an address from a base register value and an offset register value, loads a halfword from memory, sign-extends it to form a 32-bit word, and writes it to a register. The offset register value can be shifted left by 0, 1, 2, or 3 bits. See *Memory accesses* on page A5-13 for information about memory accesses.

Encoding

T1 LDRSH<c> <Rt>, [<Rn>, <Rm>]

15	14	13	12	11	10	9	8	7	6	5	4	3	2	1	0
0	1	0	1	1	1		Rm		Rn						Rt

```
t = UInt(Rt); n = UInt(Rn); m = UInt(Rm);
(shift_t, shift_n) = (SRTYPE_None, 0);
```

T2 LDRSH<c>.W <Rt>, [<Rn>, <Rm>{, LSL #<shift>}]

15	14	13	12	11	10	9	8	7	6	5	4	3	2	1	0	15	14	13	12	11	10	9	8	7	6	5	4	3	2	1	0
1	1	1	1	1	0	0	1	0	0	1	1		Rn					Rt		0	0	0	0	0	0	shift		Rm			

```
t = UInt(Rt); n = UInt(Rn); m = UInt(Rm);
(shift_t, shift_n) = (SRTYPE_LSL, UInt(shift));
if n == 15 then SEE LDRSH (literal) on page A5-143;
if t == 15 then SEE Memory hints on page A5-14;
if t == 13 || BadReg(m) then UNPREDICTABLE;
```

Architecture versions

Encoding T1 All versions of the Thumb instruction set.

Encoding T2 All versions of the Thumb instruction set from Thumb-2 onwards.

Assembler syntax

```
LDRSH<c><q> <Rt>, [<Rn>, <Rm> {, LSL #<shift>}]
```

where:

- <c><q> See *Standard assembler syntax fields* on page A5-6.
- <Rt> Specifies the destination register.
- <Rn> Specifies the register that contains the base value. This register is allowed to be the SP.
- <Rm> Contains the offset that is shifted left and added to the value of <Rn> to form the address.
- <shift> Specifies the number of bits the value from <Rm> is shifted left, in the range 0-3. If this option is omitted, a shift by 0 is assumed and both encodings are permitted. If this option is specified, only encoding T2 is permitted.

The pre-UAL syntax LDR<c>SH is equivalent to LDRSH<c>.

Operation

```
if ConditionPassed() then
    EncodingSpecificOperations();
    address = R[n] + LSL(R[m], shift_n);
    R[t] = SignExtend(MemU[address, 2], 32);
```

Exceptions

UsageFault, MemManage, BusFault.

A5.7.64 LDRSHT

Load Register Signed Halfword Unprivileged calculates an address from a base register value and an immediate offset, loads a halfword from memory, sign-extends it to form a 32-bit word, and writes it to a register. See *Memory accesses* on page A5-13 for information about memory accesses.

The memory access is restricted as if the processor were running unprivileged. (This makes no difference if the processor is actually running unprivileged.)

Encoding

T1 LDRSHT<c> <Rt>, [<Rn>, #<imm8>]

15	14	13	12	11	10	9	8	7	6	5	4	3	2	1	0	15	14	13	12	11	10	9	8	7	6	5	4	3	2	1	0
1	1	1	1	1	0	0	1	0	0	1	1	Rn				Rt				1	1	1	0	imm8							

```
t = UInt(Rt); n = UInt(Rn); imm32 = ZeroExtend(imm8, 32);
if n == 15 then SEE LDRSH (literal) on page A5-143;
if BadReg(t) then UNPREDICTABLE;
```

Architecture versions

Encoding T1 All versions of the Thumb instruction set from Thumb-2 onwards.

Assembler syntax

```
LDRSHT<c><q> <Rt>, [<Rn> {, #<imm>}]
```

where:

- <c><q> See *Standard assembler syntax fields* on page A5-6.
- <Rt> Specifies the destination register.
- <Rn> Specifies the base register. This register is allowed to be the SP.
- <imm> Specifies the immediate offset added to the value of <Rn> to form the address. The range of allowed values is 0-255. <imm> can be omitted, meaning an offset of 0.

Operation

```
if ConditionPassed() then
    EncodingSpecificOperations();
    address = R[n] + imm32;
    R[t] = SignExtend(MemU_unpriv[address, 2], 32);
```

Exceptions

UsageFault, MemManage, BusFault.

A5.7.65 LDRT

Load Register Unprivileged calculates an address from a base register value and an immediate offset, loads a word from memory, and writes it to a register. See *Memory accesses* on page A5-13 for information about memory accesses.

The memory access is restricted as if the processor were running unprivileged. (This makes no difference if the processor is actually running unprivileged.)

Encoding

T1 LDRT<c> <Rt>, [<Rn>, #<imm8>]

15	14	13	12	11	10	9	8	7	6	5	4	3	2	1	0	15	14	13	12	11	10	9	8	7	6	5	4	3	2	1	0
1	1	1	1	1	0	0	0	0	1	0	1	Rn				Rt				1	1	1	0	imm8							

```
t = UInt(Rt); n = UInt(Rn); imm32 = ZeroExtend(imm8, 32);
if n == 15 then SEE LDR (literal) on page A5-105;
if BadReg(t) then UNPREDICTABLE;
```

Architecture versions

Encoding T1 All versions of the Thumb instruction set from Thumb-2 onwards.

Assembler syntax

```
LDRT<c><q> <Rt>, [<Rn> {, #<imm>}]
```

where:

- <c><q> See *Standard assembler syntax fields* on page A5-6.
- <Rt> Specifies the destination register.
- <Rn> Specifies the base register. This register is allowed to be the SP.
- <imm> Specifies the immediate offset added to the value of <Rn> to form the address. The range of allowed values is 0-255. <imm> can be omitted, meaning an offset of 0.

The pre-UAL syntax LDR<c>T is equivalent to LDRT<c>.

Operation

```
if ConditionPassed() then
    EncodingSpecificOperations();
    address = R[n] + imm32;
    R[t] = MemU_unpriv[address, 4];
```

Exceptions

UsageFault, MemManage, BusFault.

A5.7.66 LSL (immediate)

Logical Shift Left (immediate) shifts a register value left by an immediate number of bits, shifting in zeros, and writes the result to the destination register. It can optionally update the condition flags based on the result.

Encodings

T1 LSLS <Rd>, <Rm>, #<imm5> Outside IT block.
 LSL<c> <Rd>, <Rm>, #<imm5> Inside IT block.

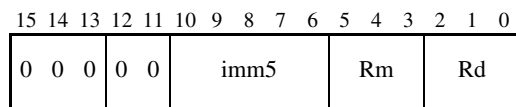

```
d = UInt(Rd); m = UInt(Rm); setflags = !InITBlock();
if imm5 == '00000' then SEE MOV (register) on page A5-169;
(-, shift_n) = DecodeImmShift('00', imm5);
```

T2 LSL{S}<c>.W <Rd>, <Rm>, #<imm5>

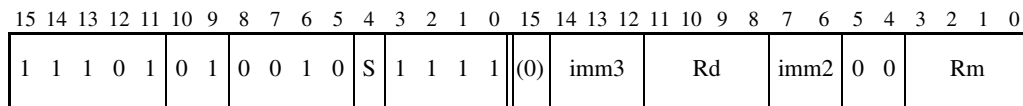

```
d = UInt(Rd); m = UInt(Rm); setflags = (S == '1');
if imm3:imm2 == '00000' then SEE MOV (register) on page A5-169;
(-, shift_n) = DecodeImmShift('00', imm3:imm2);
if BadReg(d) || BadReg(m) THEN UNPREDICTABLE;
```

Architecture versions

Encoding T1 All versions of the Thumb instruction set.

Encoding T2 All versions of the Thumb instruction set from Thumb-2 onwards.

Assembler syntax

```
LSL{S}<c><q> <Rd>, <Rm>, #<imm5>
```

where:

S	If present, specifies that the instruction updates the flags. Otherwise, the instruction does not update the flags.
<c><q>	See <i>Standard assembler syntax fields</i> on page A5-6.
<Rd>	Specifies the destination register.
<Rm>	Specifies the register that contains the first operand.
<imm5>	Specifies the shift amount, in the range 0 to 31. See <i>Constant shifts applied to a register</i> on page A5-10.

Operation

```
if ConditionPassed() then
    EncodingSpecificOperations();
    (result, carry) = Shift_C(R[m], SRTYPE_LSL, shift_n, APSR.C);
    R[d] = result;
    if setflags then
        APSR.N = result<31>;
        APSR.Z = IsZeroBit(result);
        APSR.C = carry;
        // APSR.V unchanged
```

Exceptions

None.

Assembler syntax

```
LSL{S}<c><q> <Rd>, <Rn>, <Rm>
```

where:

- S If present, specifies that the instruction updates the flags. Otherwise, the instruction does not update the flags.
- <c><q> See *Standard assembler syntax fields* on page A5-6.
- <Rd> Specifies the destination register.
- <Rn> Specifies the register that contains the first operand.
- <Rm> Specifies the register whose bottom byte contains the amount to shift by.

Operation

```
if ConditionPassed() then
    EncodingSpecificOperations();
    shift_n = UInt(R[m]<7:0>);
    (result, carry) = Shift_C(R[n], SRTYPE_LSL, shift_n, APSR.C);
    R[d] = result;
    if setflags then
        APSR.N = result<31>;
        APSR.Z = IsZeroBit(result);
        APSR.C = carry;
        // APSR.V unchanged
```

Exceptions

None.

A5.7.68 LSR (immediate)

Logical Shift Right (immediate) shifts a register value right by an immediate number of bits, shifting in zeros, and writes the result to the destination register. It can optionally update the condition flags based on the result.

Encodings

T1 LSRS <Rd>, <Rm>, #<imm5> Outside IT block.
 LSR<c> <Rd>, <Rm>, #<imm5> Inside IT block.

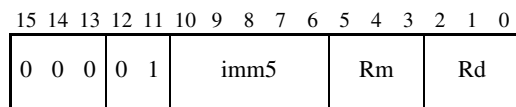

```
d = UInt(Rd); m = UInt(Rm); setflags = !InITBlock();
(-, shift_n) = DecodeImmShift('01', imm5);
```

T2 LSR{S}<c>.W <Rd>, <Rm>, #<imm5>

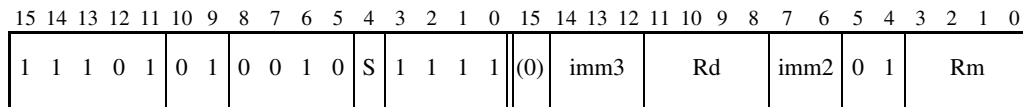

```
d = UInt(Rd); m = UInt(Rm); setflags = (S == '1');
(-, shift_n) = DecodeImmShift('01', imm3:imm2);
if BadReg(d) || BadReg(m) THEN UNPREDICTABLE;
```

Architecture versions

Encoding T1 All versions of the Thumb instruction set.

Encoding T2 All versions of the Thumb instruction set from Thumb-2 onwards.

Assembler syntax

```
LSR{S}<c><q> <Rd>, <Rm>, #<imm5>
```

where:

S	If present, specifies that the instruction updates the flags. Otherwise, the instruction does not update the flags.
<c><q>	See <i>Standard assembler syntax fields</i> on page A5-6.
<Rd>	Specifies the destination register.
<Rm>	Specifies the register that contains the first operand.
<imm5>	Specifies the shift amount, in the range 1 to 32. See <i>Constant shifts applied to a register</i> on page A5-10.

Operation

```
if ConditionPassed() then
    EncodingSpecificOperations();
    (result, carry) = Shift_C(R[m], SRTYPE_LSR, shift_n, APSR.C);
    R[d] = result;
    if setflags then
        APSR.N = result<31>;
        APSR.Z = IsZeroBit(result);
        APSR.C = carry;
        // APSR.V unchanged
```

Exceptions

None.

A5.7.69 LSR (register)

Logical Shift Left (register) shifts a register value right by a variable number of bits, shifting in zeros, and writes the result to the destination register. The variable number of bits is read from the bottom byte of a register. It can optionally update the condition flags based on the result.

Encodings

T1 LSRS <Rdn>, <Rm> Outside IT block.
 LSR<c> <Rdn>, <Rm> Inside IT block.

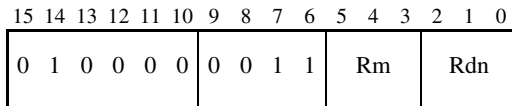

```
d = UInt(Rdn); n = UInt(Rdn); m = UInt(Rm); setflags = !InITBlock();
```

T2 LSR{S}<c>.W <Rd>, <Rn>, <Rm>

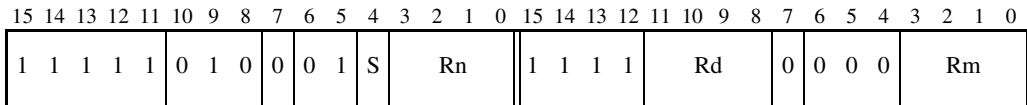

```
d = UInt(Rd); n = UInt(Rn); m = UInt(Rm); setflags = (S == '1');
if BadReg(d) || BadReg(n) || BadReg(m) then UNPREDICTABLE;
```

Architecture versions

Encoding T1 All versions of the Thumb instruction set

Encoding T2 All versions of the Thumb instruction set from Thumb-2 onwards.

Assembler syntax

```
LSR{S}<c><q> <Rd>, <Rn>, <Rm>
```

where:

- S If present, specifies that the instruction updates the flags. Otherwise, the instruction does not update the flags.
- <c><q> See *Standard assembler syntax fields* on page A5-6.
- <Rd> Specifies the destination register.
- <Rn> Specifies the register that contains the first operand.
- <Rm> Specifies the register whose bottom byte contains the amount to shift by.

Operation

```
if ConditionPassed() then
    EncodingSpecificOperations();
    shift_n = UInt(R[m]<7:0>);
    (result, carry) = Shift_C(R[n], SRTYPE_LSR, shift_n, APSR.C);
    R[d] = result;
    if setflags then
        APSR.N = result<31>;
        APSR.Z = IsZeroBit(result);
        APSR.C = carry;
        // APSR.V unchanged
```

Exceptions

None.

A5.7.70 MCR, MCR2

Move to Coprocessor from ARM Register passes the value of an ARM register to a coprocessor.

If no coprocessor can execute the instruction, a UsageFault exception is generated.

Encodings

T1 MCR<c> <coproc>, <opc1>, <Rt>, <CRn>, <CRm>{, <opc2>}

15	14	13	12	11	10	9	8	7	6	5	4	3	2	1	0	15	14	13	12	11	10	9	8	7	6	5	4	3	2	1	0
1	1	1	C	1	1	1	0	opc1	0	CRn					Rt					coproc					opc2	1	CRm				

```
t = UInt(Rt); cp = UInt(coproc); opc0 = C; // MCR if C == '0', MCR2 if C == '1'
if BadReg(t) then UNPREDICTABLE;
```

Architecture versions

Encoding T1 All versions of the Thumb instruction set from Thumb-2 onwards.

Assembler syntax

```
MCR{2}<c><q> <coproc>, #<opc1>, <Rt>, <CRn>, <CRm>{, #<opc2>}
```

where:

- 2 If specified, selects the C == 1 form of the encoding. If omitted, selects the C == 0 form.
- <c><q> See *Standard assembler syntax fields* on page A5-6.
- <coproc> Specifies the name of the coprocessor. The standard generic coprocessor names are p0, p1, ..., p15.
- <opc1> Is a coprocessor-specific opcode in the range 0 to 7.
- <Rt> Is the ARM register whose value is transferred to the coprocessor.
- <CRn> Is the destination coprocessor register.
- <CRm> Is an additional destination coprocessor register.
- <opc2> Is a coprocessor-specific opcode in the range 0-7. If it is omitted, <opc2> is assumed to be 0.

Operation

```
if ConditionPassed() then
    EncodingSpecificOperations();
if !Coprocc_Accepted(cp, ThisInstr()) then
    RaiseCoproccorException();
else
    Coproc_SendOneWord(R[t], cp, ThisInstr());
```

Exceptions

UsageFault.

Notes

- Coprocessor fields** Only instruction bits[31:24], bit[20], bits[15:8], and bit[4] are defined by the ARM architecture. The remaining fields are recommendations.

A5.7.71 MCRR, MCRR2

Move to Coprocessor from two ARM Registers passes the values of two ARM registers to a coprocessor.

If no coprocessor can execute the instruction, a UsageFault exception is generated.

Encodings

T1 MCRR<c> <coproc>, <opc1>, <Rt>, <Rt2>, <CRm>

15	14	13	12	11	10	9	8	7	6	5	4	3	2	1	0	15	14	13	12	11	10	9	8	7	6	5	4	3	2	1	0
1	1	1	C	1	1	0	0	0	1	0	0	Rt2				Rt				coproc				opc1				CRm			

```
t = UInt(Rt);  t2 = UInt(Rt2);
cp = UInt(coproc);  opc0 = C;  // MCRR if C == '0', MCRR2 if C == '1'
if BadReg(t) || BadReg(t2) then UNPREDICTABLE;
```

Architecture versions

Encoding T1 All versions of the Thumb instruction set from Thumb-2 onwards.

Assembler syntax

MCRR{2}<c><q> <coproc>, #<opc1>, <Rt>, <Rt2>, <CRm>

where:

2 If specified, selects the C ==1 form of the encoding. If omitted, selects the C == 0 form.

<c><q> See *Standard assembler syntax fields* on page A5-6.

<coproc> Specifies the name of the coprocessor.
The standard generic coprocessor names are p0, p1, ..., p15.

<opc1> Is a coprocessor-specific opcode in the range 0 to 15.

<Rt> Is the first ARM register whose value is transferred to the coprocessor.

<Rt2> Is the second ARM register whose value is transferred to the coprocessor.

<CRm> Is the destination coprocessor register.

Operation

```
if ConditionPassed() then
    EncodingSpecificOperations();
    if !Coprocc_Accepted(cp, ThisInstr()) then
        RaiseCoproccorException();
    else
        Coproc_SendTwoWords(R[t], R[t2], cp, ThisInstr());
```

Exceptions

UsageFault.

A5.7.72 MLA

Multiply Accumulate multiplies two register values, and adds a third register value. The least significant 32 bits of the result are written to the destination register. These 32 bits do not depend on whether signed or unsigned calculations are performed.

Encodings

T1 MLA<c> <Rd>, <Rn>, <Rm>, <Ra>

15	14	13	12	11	10	9	8	7	6	5	4	3	2	1	0	15	14	13	12	11	10	9	8	7	6	5	4	3	2	1	0
1	1	1	1	1	0	1	1	0	0	0	0	Rn			Ra			Rd			0	0	0	0	Rm						

```
d = UInt(Rd); n = UInt(Rn); m = UInt(Rm); a = UInt(Ra);
if a == 15 then SEE MUL on page A5-180;
if BadReg(d) || BadReg(n) || BadReg(m) || a == 13 then UNPREDICTABLE;
```

Architecture versions

Encoding T1 All versions of the Thumb instruction set from Thumb-2 onwards.

Assembler syntax

```
MLA<c><q> <Rd>, <Rn>, <Rm>, <Ra>
```

where:

- <c><q> See *Standard assembler syntax fields* on page A5-6.
- <Rd> Specifies the destination register.
- <Rn> Specifies the register that contains the first operand.
- <Rm> Specifies the register that contains the second operand.
- <Ra> Specifies the register containing the accumulate value.

Operation

```
if ConditionPassed() then
    EncodingSpecificOperations();
    operand1 = SInt(R[n]); // or UInt(R[n]) without functionality change
    operand2 = SInt(R[m]); // or UInt(R[m]) without functionality change
    addend   = SInt(R[a]); // or UInt(R[a]) without functionality change
    result = operand1 * operand2 + addend;
    R[d] = result<31:0>;
```

Exceptions

None.

A5.7.73 MLS

Multiply and Subtract multiplies two register values, and subtracts the least significant 32 bits of the result from a third register value. These 32 bits do not depend on whether signed or unsigned calculations are performed. The result is written to the destination register.

Encodings

T1 MLS<c> <Rd>, <Rn>, <Rm>, <Ra>

15	14	13	12	11	10	9	8	7	6	5	4	3	2	1	0	15	14	13	12	11	10	9	8	7	6	5	4	3	2	1	0
1	1	1	1	1	0	1	1	0	0	0	0	Rn			Ra			Rd			0	0	0	1	Rm						

```
d = UInt(Rd); n = UInt(Rn); m = UInt(Rm); a = UInt(Ra);
if BadReg(d) || BadReg(n) || BadReg(m) || BadReg(a) then UNPREDICTABLE;
```

Architecture versions

Encoding T1 All versions of the Thumb instruction set from Thumb-2 onwards.

Assembler syntax

MLS<c><q> <Rd>, <Rn>, <Rm>, <Ra>

where:

- <c><q> See *Standard assembler syntax fields* on page A5-6.
- <Rd> Specifies the destination register.
- <Rn> Specifies the register that contains the first operand.
- <Rm> Specifies the register that contains the second operand.
- <Ra> Specifies the register containing the accumulate value.

Operation

```
if ConditionPassed() then
    EncodingSpecificOperations();
    operand1 = SInt(R[n]); // or UInt(R[n]) without functionality change
    operand2 = SInt(R[m]); // or UInt(R[m]) without functionality change
    addend = SInt(R[a]); // or UInt(R[a]) without functionality change
    result = addend - operand1 * operand2;
    R[d] = result<31:0>;
```

Exceptions

None.

Assembler syntax

MOV{S}<c><q> <Rd>, #<const> All encodings permitted
 MOVW<c><q> <Rd>, #<const> Only encoding T3 permitted

where:

S If present, specifies that the instruction updates the flags. Otherwise, the instruction does not update the flags.

<c><q> See *Standard assembler syntax fields* on page A5-6.

<Rd> Specifies the destination register.

<const> Specifies the immediate value to be placed in <Rd>. The range of allowed values is 0-255 for encoding T1 and 0-65535 for encoding T3. See *Immediate constants* on page A5-8 for the range of allowed values for encoding T2.

When both 32-bit encodings are available for an instruction, encoding T2 is preferred to encoding T3 (if encoding T3 is required, use the MOVW syntax).

The pre-UAL syntax MOV<c>S is equivalent to MOV<c>S.

Operation

```
if ConditionPassed() then
    EncodingSpecificOperations();
    result = imm32;
    R[d] = result;
    if setflags then
        APSR.N = result<31>;
        APSR.Z = IsZeroBit(result);
        APSR.C = carry;
        // APSR.V unchanged
```

Exceptions

None.

A5.7.75 MOV (register)

Move (register) copies a value from a register to the destination register. It can optionally update the condition flags based on the value.

Encodings

T1 MOV<c> <Rd>, <Rm>

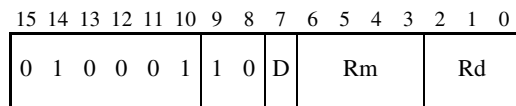

```
d = UInt(D:Rd); m = UInt(Rm); setflags = FALSE;
if d == 15 && InITBlock() && !LastInITBlock() then UNPREDICTABLE;
```

T2 MOVS <Rd>, <Rm>

Not allowed inside IT block

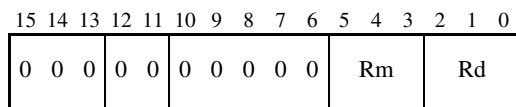

```
d = UInt(Rd); m = UInt(Rm); setflags = TRUE;
if InITBlock() then UNPREDICTABLE;
```

T3 MOV{S}<c>.W <Rd>, <Rm>

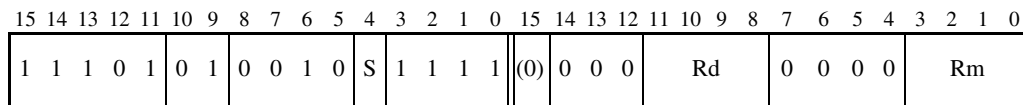

```
d = UInt(Rd); m = UInt(Rm); setflags = (S == '1');
if (BadReg(d) || BadReg(m)) && setflags THEN UNPREDICTABLE;
if BadReg(d) && BadReg(m) then UNPREDICTABLE;
if d == 15 && InITBlock() && !LastInITBlock() then UNPREDICTABLE;
```

Architecture versions

Encoding T1 All versions of the Thumb instruction set. Before Thumb-2, encoding T1 required that either <Rdn>, or <Rm>, or both, had to be from {R8-R12, SP, LR}.

Encoding T2 All versions of the Thumb instruction set. Before UAL, this encoding was documented as an LSL instruction with an immediate shift by 0.

Encoding T3 All versions of the Thumb instruction set from Thumb-2 onwards.

Assembler syntax

```
MOV{S}<c><q> <Rd>, <Rm>
```

where:

- S If present, specifies that the instruction updates the flags. Otherwise, the instruction does not update the flags.
- <c><q> See *Standard assembler syntax fields* on page A5-6.
- <Rd> Specifies the destination register. This register is permitted to be SP or PC, provided S is not specified and <Rm> is neither of SP and PC. If it is the PC, it causes a branch to the address (data) moved to the PC, and the instruction must either be outside an IT block or the last instruction of an IT block.
- <Rm> Specifies the source register. This register is permitted to be SP or PC, provided S is not specified and <Rd> is neither of SP and PC.

The pre-UAL syntax `MOV<c>S` is equivalent to `MOVS<c>`.

Operation

```
if ConditionPassed() then
    EncodingSpecificOperations();
    result = R[m];    if d == 15 then
        ALUWritePC(result); // setflags is always FALSE here
    else
        R[d] = result;
        if setflags then
            APSR.N = result<31>;
            APSR.Z = IsZeroBit(result);
            APSR.C = carry;
            // APSR.V unchanged
```

Exceptions

None.

A5.7.76 MOV (shifted register)

Move (shifted register) is a synonym for ASR, LSL, LSR, ROR, and RRX.

See the following sections for details:

- *ASR (immediate)* on page A5-36
- *ASR (register)* on page A5-38
- *LSL (immediate)* on page A5-151
- *LSL (register)* on page A5-153
- *LSR (immediate)* on page A5-155
- *LSR (register)* on page A5-157
- *ROR (immediate)* on page A5-218
- *ROR (register)* on page A5-220
- *RRX* on page A5-222.

Assembler syntax

Table A5-2 shows the equivalences between MOV (shifted register) and other instructions.

Table A5-2 MOV (shift, register shift) equivalences

MOV instruction	Canonical form
MOV{S} <Rd>, <Rm>, ASR #<n>	ASR{S} <Rd>, <Rm>, #<n>
MOV{S} <Rd>, <Rm>, LSL #<n>	LSL{S} <Rd>, <Rm>, #<n>
MOV{S} <Rd>, <Rm>, LSR #<n>	LSR{S} <Rd>, <Rm>, #<n>
MOV{S} <Rd>, <Rm>, ROR #<n>	ROR{S} <Rd>, <Rm>, #<n>
MOV{S} <Rd>, <Rm>, ASR <Rs>	ASR{S} <Rd>, <Rm>, <Rs>
MOV{S} <Rd>, <Rm>, LSL <Rs>	LSL{S} <Rd>, <Rm>, <Rs>
MOV{S} <Rd>, <Rm>, LSR <Rs>	LSR{S} <Rd>, <Rm>, <Rs>
MOV{S} <Rd>, <Rm>, ROR <Rs>	ROR{S} <Rd>, <Rm>, <Rs>
MOV{S} <Rd>, <Rm>, RRX	RRX{S} <Rd>, <Rm>

The canonical form of the instruction is produced on disassembly.

Exceptions

None.

A5.7.77 MOV_T

Move Top writes an immediate value to the top halfword of the destination register. It does not affect the contents of the bottom halfword.

Encodings

T1 MOV_T<c> <Rd>, #<imm16>

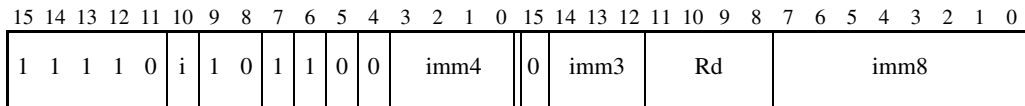

```
d = UInt(Rd); imm16 = imm4:i:imm3:imm8;
if BadReg(d) then UNPREDICTABLE;
```

Architecture versions

Encoding T1 All versions of the Thumb instruction set from Thumb-2 onwards.

Assembler syntax

MOVT<c><q> <Rd>, #<imm16>

where:

<c><q> See *Standard assembler syntax fields* on page A5-6.

<Rd> Specifies the destination register.

<imm16> Specifies the immediate value to be written to <Rd>. It must be in the range 0-65535.

Operation

```
if ConditionPassed() then
    EncodingSpecificOperations();
    R[d]<31:16> = imm16;
    // R[d]<15:0> unchanged
```

Exceptions

None.

A5.7.78 MRC, MRC2

Move to ARM Register from Coprocessor causes a coprocessor to transfer a value to an ARM register or to the condition flags.

If no coprocessor can execute the instruction, a UsageFault exception is generated.

Encodings

T1 MRC{2}<c> <coproc>, <opc1>, <Rt>, <CRn>, <CRm>{, <opc2>}

15	14	13	12	11	10	9	8	7	6	5	4	3	2	1	0	15	14	13	12	11	10	9	8	7	6	5	4	3	2	1	0
1	1	1	C	1	1	1	0	opc1		1	CRn				Rt				coproc				opc2		1	CRm					

```
t = UInt(Rt); cp = UInt(coproc);
opc0 = C; // MRC if C == '0', MRC2 if C == '1'
if t == 13 then UNPREDICTABLE;
```

Architecture versions

Encoding T1 All versions of the Thumb instruction set from Thumb-2 onwards.

Assembler syntax

```
MRC{2}<c><q> <coproc>, #<opc1>, <Rt>, <CRn>, <CRm>{, #<opc2>}
```

where:

- 2 If specified, selects the C == 1 form of the encoding. If omitted, selects the C == 0 form.
- <c><q> See *Standard assembler syntax fields* on page A5-6.
- <coproc> Specifies the name of the coprocessor. The standard generic coprocessor names are p0, p1, ..., p15.
- <opc1> Is a coprocessor-specific opcode in the range 0 to 7.
- <Rt> Is the destination ARM register. This register is allowed to be R0-R14 or APSR_nzcv. The last form writes bits[31:28] of the transferred value to the N, Z, C and V condition flags and is specified by setting the Rt field of the encoding to 0b1111. In pre-UAL assembler syntax, PC was written instead of APSR_nzcv to select this form.
- <CRn> Is the coprocessor register that contains the first operand.
- <CRm> Is an additional source or destination coprocessor register.
- <opc2> Is a coprocessor-specific opcode in the range 0 to 7. If it is omitted, <opc2> is assumed to be 0.

Operation

```
if ConditionPassed() then
    EncodingSpecificOperations();
    if !Coprocc_Accepted(cp, ThisInstr()) then
        RaiseCoproccorException();
    else
        value = Coproc_GetOneWord(cp, ThisInstr());
        if t != 15 then
            R[t] = value;
        else
            APSR.N = value<31>;
            APSR.Z = value<30>;
            APSR.C = value<29>;
            APSR.V = value<28>;
            // value<27:0> are not used.
```

Exceptions

UsageFault.

A5.7.79 MRRC, MRRC2

Move to two ARM Registers from Coprocessor causes a coprocessor to transfer values to two ARM registers.

If no coprocessor can execute the instruction, a UsageFault exception is generated.

Encodings

T1 MRRC<c> <coproc>, <opc>, <Rt>, <Rt2>, <CRm>

15	14	13	12	11	10	9	8	7	6	5	4	3	2	1	0	15	14	13	12	11	10	9	8	7	6	5	4	3	2	1	0
1	1	1	C	1	1	0	0	0	1	0	1	Rt2				Rt				coproc				opc1				CRm			

```
t = UInt(Rt);  t2 = UInt(Rt2);
cp = UInt(coproc);  opc0 = C;  // MRRC if C == '0', MRRC2 if C == '1'
if BadReg(t) || BadReg(t2) || t1 == t2 then UNPREDICTABLE;
```

Architecture versions

Encoding T1 All versions of the Thumb instruction set from Thumb-2 onwards.

Assembler syntax

```
MRRC{2}<c><q> <coproc>, #<opc1>, <Rt>, <Rt2>, <CRm>
```

where:

- 2 If specified, selects the C == 1 form of the encoding. If omitted, selects the C == 0 form.
- <c><q> See *Standard assembler syntax fields* on page A5-6.
- <coproc> Specifies the name of the coprocessor. The standard generic coprocessor names are p0, p1, ..., p15.
- <opc1> Is a coprocessor-specific opcode in the range 0 to 15.
- <Rt> Is the first destination ARM register.
- <Rt2> Is the second destination ARM register.
- <CRm> Is the coprocessor register that supplies the data to be transferred.

Operation

```
if ConditionPassed() then
    EncodingSpecificOperations();
    if !Coprocc_Accepted(cp, ThisInstr()) then
        RaiseCoproccorException();
    else
        (R[t], R[t2]) = Coproc_GetTwoWords(cp, ThisInstr());
```

Exceptions

UsageFault.

A5.7.80 MRS

Move to Register from Special register moves the value from the selected special-purpose register into a general-purpose ARM register.

Encodings

T1 MRS<c> <Rd>, <spec_reg>

15	14	13	12	11	10	9	8	7	6	5	4	3	2	1	0	15	14	13	12	11	10	9	8	7	6	5	4	3	2	1	0	
1	1	1	1	0	0	1	1	1	1	1	0	(1)	(1)	(1)	(1)	(1)	1	0	(0)	0	Rd						SYSm					

Architecture versions

Encoding T1 ARMv7-M specific behaviour. The instruction is present in all versions of the Thumb instruction set from Thumb-2 onwards.

Note

MRS is a system level instruction except when accessing the APSR (SYSm = 0). For the complete instruction definition see *MRS* on page B3-5.

A5.7.81 MSR (register)

Move to Special Register from ARM Register moves the value of a general-purpose ARM register to the specified special-purpose register.

Encodings

T1 MSR<c> <spec_reg>, <Rn>

15	14	13	12	11	10	9	8	7	6	5	4	3	2	1	0	15	14	13	12	11	10	9	8	7	6	5	4	3	2	1	0	
1	1	1	1	0	0	1	1	1	0	0	R		Rn			1	0	(0)	0		mask											SYSm

Architecture versions

Encoding T1 ARMv7-M specific behaviour. The instruction is present in all versions of the Thumb instruction set from Thumb-2 onwards.

Note

MSR(register) is a system level instruction except when accessing the APSR (SYSm = 0). For the complete instruction definition see *MSR (register)* on page B3-9.

A5.7.82 MUL

Multiply multiplies two register values. The least significant 32 bits of the result are written to the destination register. These 32 bits do not depend on whether signed or unsigned calculations are performed.

It can optionally update the condition flags based on the result. This option is limited to only a few forms of the instruction in the Thumb instruction set, and use of it will adversely affect performance on many processor implementations.

Encodings

T1 MULS <Rdm>, <Rn>, <Rdm> Outside IT block.
 MUL<c> <Rdm>, <Rn>, <Rdm> Inside IT block.

15	14	13	12	11	10	9	8	7	6	5	4	3	2	1	0
0 1 0 0 0 0						1 1 0 1				Rn		Rdm			

```
d = UInt(Rdm); n = UInt(Rn); m = UInt(Rdm); setflags = !InITBlock();
if ArchVersion() < 6 && d == m then UNPREDICTABLE;
```

T2 MUL<c> <Rd>, <Rn>, <Rm>

15	14	13	12	11	10	9	8	7	6	5	4	3	2	1	0	15	14	13	12	11	10	9	8	7	6	5	4	3	2	1	0
1 1 1 1 1						0 1 1 0			0 0 0			Rn			1 1 1 1			Rd			0 0 0 0			Rm							

```
d = UInt(Rd); n = UInt(Rn); m = UInt(Rm); setflags = FALSE;
if BadReg(d) || BadReg(n) || BadReg(m) then UNPREDICTABLE;
```

Architecture versions

Encoding T1 All versions of the Thumb instruction set.

Encoding T2 All versions of the Thumb instruction set from Thumb-2 onwards.

Assembler syntax

```
MUL<c><q> {<Rd>,<Rn>, <Rm>
```

where:

- <c><q> See *Standard assembler syntax fields* on page A5-6.
- <Rd> Specifies the destination register. If <Rd> is omitted, this register is the same as <Rn>.
- <Rn> Specifies the register that contains the first operand.
- <Rm> Specifies the register that contains the second operand.

Operation

```
if ConditionPassed() then
    EncodingSpecificOperations();
    operand1 = SInt(R[n]); // or UInt(R[n]) without functionality change
    operand2 = SInt(R[m]); // or UInt(R[m]) without functionality change
    result = operand1 * operand2;
    R[d] = result<31:0>;
    if setflags then
        APSR.N = result<31>;
        APSR.Z = IsZeroBit(result);
        if ArchVersion() == 4 then
            APSR.C = UNKNOWN;
        // else APSR.C unchanged
        // APSR.V always unchanged
```

Exceptions

None.

Notes

Early termination

If the multiplier implementation supports early termination, it must be implemented on the value of the <Rm> operand. The type of early termination used (signed or unsigned) is IMPLEMENTATION DEFINED. This implies that MUL{S}<c> {<Rdn>, }<Rdn>, <Rm> cannot be assembled correctly using encoding T1, unless <Rdn> and <Rm> are the same register.

A5.7.83 MVN (immediate)

Move Negative (immediate) writes the logical ones complement of an immediate value to the destination register. It can optionally update the condition flags based on the value.

Encodings

T1 MVN{S}<c> <Rd>, #<const>

15	14	13	12	11	10	9	8	7	6	5	4	3	2	1	0	15	14	13	12	11	10	9	8	7	6	5	4	3	2	1	0
1	1	1	1	0	i	0	0	0	1	1	S	1	1	1	1	0	imm3			Rd			imm8								

```
d = UInt(Rd); setflags = (S == '1');
(imm32, carry) = ThumbExpandImmWithC(i:imm3:imm8, APSR.C);
if BadReg(d) then UNPREDICTABLE;
```

Architecture versions

Encoding T1 All versions of the Thumb instruction set from Thumb-2 onwards.

Assembler syntax

```
MVN{S}<c><q> <Rd>, #<const>
```

where:

- S If present, specifies that the instruction updates the flags. Otherwise, the instruction does not update the flags.
- <c><q> See *Standard assembler syntax fields* on page A5-6.
- <Rd> Specifies the destination register.
- <const> Specifies the immediate value to be added to the value obtained from <Rn>. See *Immediate constants* on page A5-8 for the range of allowed values.

The pre-UAL syntax MVN<c>S is equivalent to MVNS<c>.

Operation

```
if ConditionPassed() then
    EncodingSpecificOperations();
    result = NOT(imm32);
    R[d] = result;
    if setflags then
        APSR.N = result<31>;
        APSR.Z = IsZeroBit(result);
        APSR.C = carry;
        // APSR.V unchanged
```

Exceptions

None.

A5.7.84 MVN (register)

Move Negative (register) writes the logical ones complement of a register value to the destination register. It can optionally update the condition flags based on the result.

Encodings

T1 MVNS <Rd>, <Rm> Outside IT block.
 MVN<c> <Rd>, <Rm> Inside IT block.

15	14	13	12	11	10	9	8	7	6	5	4	3	2	1	0
0	1	0	0	0	0	1	1	1	1	Rm	Rd				

```
d = UInt(Rd); m = UInt(Rm); setflags = !InITBlock();
(shift_t, shift_n) = (SRTYPE_None, 0);
```

T2 MVN{S}<c>.W <Rd>, <Rm>{, shift}

15	14	13	12	11	10	9	8	7	6	5	4	3	2	1	0	15	14	13	12	11	10	9	8	7	6	5	4	3	2	1	0
1	1	1	0	1	0	1	0	0	1	1	S	1	1	1	1	(0)	imm3	Rd	imm2	type	Rm										

```
d = UInt(Rd); m = UInt(Rm); setflags = (S == '1');
(shift_t, shift_n) = DecodeImmShift(type, imm3:imm2);
if BadReg(d) || BadReg(m) THEN UNPREDICTABLE;
```

Architecture versions

Encoding T1 All versions of the Thumb instruction set.

Encoding T2 All versions of the Thumb instruction set from Thumb-2 onwards.

Assembler syntax

```
MVN{S}<c><q> <Rd>, <Rm> {, <shift>}
```

where:

- S** If present, specifies that the instruction updates the flags. Otherwise, the instruction does not update the flags.
- <c><q>** See *Standard assembler syntax fields* on page A5-6.
- <Rd>** Specifies the destination register.
- <Rm>** Specifies the register that is optionally shifted and used as the source register.
- <shift>** Specifies the shift to apply to the value read from <Rm>. If <shift> is omitted, no shift is applied and both encodings are permitted. If <shift> is specified, only encoding T2 is permitted. The possible shifts and how they are encoded are described in *Constant shifts applied to a register* on page A5-10.

The pre-UAL syntax MVN<c>S is equivalent to MVNS<c>.

Operation

```
if ConditionPassed() then
    EncodingSpecificOperations();
    (shifted, carry) = Shift_C(R[m], shift_t, shift_n, APSR.C);
    result = NOT(shifted);
    R[d] = result;
    if setflags then
        APSR.N = result<31>;
        APSR.Z = IsZeroBit(result);
        APSR.C = carry;
        // APSR.V unchanged
```

Exceptions

None.

A5.7.85 NEG

Negate is a pre-UAL synonym for RSB (immediate) with an immediate value of 0. See *RSB (immediate)* on page A5-224 for details.

Assembler syntax

NEG<c><q> {<Rd>, } <Rm>

This is equivalent to:

RSBS<c><q> {<Rd>, } <Rm>, #0

Exceptions

None.

A5.7.86 NOP

No Operation does nothing.

This is a NOP-compatible hint (the architected NOP), see *NOP-compatible hints* on page A5-15.

Encodings

T1 NOP<C>

15	14	13	12	11	10	9	8	7	6	5	4	3	2	1	0
1	0	1	1	1	1	1	1	0	0	0	0	0	0	0	0

// Do nothing

T2 NOP<C>.W

15	14	13	12	11	10	9	8	7	6	5	4	3	2	1	0	15	14	13	12	11	10	9	8	7	6	5	4	3	2	1	0
1	1	1	1	0	0	1	1	1	0	1	0	(1)	(1)	(1)	(1)	1	0	(0)	0	(0)	0	0	0	0	0	0	0	0	0		

// Do nothing

Architecture versions

Encodings T1, T2 All versions of the Thumb instruction set from Thumb-2 onwards.

Assembler syntax

NOP<c><q>

where:

<c><q> See *Standard assembler syntax fields* on page A5-6.

Operation

```
if ConditionPassed() then
    EncodingSpecificOperations();
    // Do nothing
```

Exceptions

None.

A5.7.87 ORN (immediate)

Logical OR NOT (immediate) performs a bitwise (inclusive) OR of a register value and the complement of an immediate value, and writes the result to the destination register. It can optionally update the condition flags based on the result.

Encodings

T1 ORN{S}<c> <Rd>, <Rn>, #<const>

15	14	13	12	11	10	9	8	7	6	5	4	3	2	1	0	15	14	13	12	11	10	9	8	7	6	5	4	3	2	1	0
1	1	1	1	0	i	0	0	0	1	1	S	Rn			0	imm3			Rd			imm8									

```
d = UInt(Rd); n = UInt(Rn); setflags = (S == '1');
(imm32, carry) = ThumbExpandImmWithC(i:imm3:imm8, APSR.C);
if n == 15 then SEE MVN (immediate) on page A5-182;
if BadReg(d) || n == 13 then UNPREDICTABLE;
```

Architecture versions

Encoding T1 All versions of the Thumb instruction set from Thumb-2 onwards.

Assembler syntax

```
ORN{S}<c><q> {<Rd>}, <Rn>, #<const>
```

where:

- S If present, specifies that the instruction updates the flags. Otherwise, the instruction does not update the flags.
- <c><q> See *Standard assembler syntax fields* on page A5-6.
- <Rd> Specifies the destination register. If <Rd> is omitted, this register is the same as <Rn>.
- <Rn> Specifies the register that contains the operand.
- <const> Specifies the immediate value to be added to the value obtained from <Rn>. See *Immediate constants* on page A5-8 for the range of allowed values.

Operation

```
if ConditionPassed() then
    EncodingSpecificOperations();
    result = R[n] OR NOT(imm32);
    R[d] = result;
    if setflags then
        APSR.N = result<31>;
        APSR.Z = IsZeroBit(result);
        APSR.C = carry;
        // APSR.V unchanged
```

Exceptions

None.

A5.7.88 ORN (register)

Logical OR NOT (register) performs a bitwise (inclusive) OR of a register value and the complement of an optionally-shifted register value, and writes the result to the destination register. It can optionally update the condition flags based on the result.

Encodings

T1 ORN{S}<c> <Rd>, <Rn>, <Rm>{, <shift>}

15	14	13	12	11	10	9	8	7	6	5	4	3	2	1	0	15	14	13	12	11	10	9	8	7	6	5	4	3	2	1	0
1	1	1	0	1	0	1	0	0	1	1	S	Rn				(0)	imm3			Rd			imm2		type		Rm				

```
d = UInt(Rd); n = UInt(Rn); m = UInt(Rm); setflags = (S == '1');
(shift_t, shift_n) = DecodeImmShift(type, imm3:imm2);
if n == 15 then SEE MVN (register) on page A5-184;
if BadReg(d) || n == 13 || BadReg(m) THEN UNPREDICTABLE;
```

Architecture versions

Encoding T1 All versions of the Thumb instruction set from Thumb-2 onwards.

Assembler syntax

```
ORN{S}<c><q> {<Rd>,<Rn>,<Rm> {,<shift>}}
```

where:

S	If present, specifies that the instruction updates the flags. Otherwise, the instruction does not update the flags.
<c><q>	See <i>Standard assembler syntax fields</i> on page A5-6.
<Rd>	Specifies the destination register. If <Rd> is omitted, this register is the same as <Rn>.
<Rn>	Specifies the register that contains the first operand.
<Rm>	Specifies the register that is optionally shifted and used as the second operand.
<shift>	Specifies the shift to apply to the value read from <Rm>. If <shift> is omitted, no shift is applied. The possible shifts and how they are encoded are described in <i>Constant shifts applied to a register</i> on page A5-10.

Operation

```
if ConditionPassed() then
    EncodingSpecificOperations();
    (shifted, carry) = Shift_C(R[m], shift_t, shift_n, APSR.C);
    result = R[n] OR NOT(shifted);
    R[d] = result;
    if setflags then
        APSR.N = result<31>;
        APSR.Z = IsZeroBit(result);
        APSR.C = carry;
        // APSR.V unchanged
```

Exceptions

None.

A5.7.89 ORR (immediate)

Logical OR (immediate) performs a bitwise (inclusive) OR of a register value and an immediate value, and writes the result to the destination register. It can optionally update the condition flags based on the result.

Encodings

T1 ORR{S}<c> <Rd>, <Rn>, #<const>

15	14	13	12	11	10	9	8	7	6	5	4	3	2	1	0	15	14	13	12	11	10	9	8	7	6	5	4	3	2	1	0
1	1	1	1	0	i	0	0	0	1	0	S	Rn			0	imm3			Rd			imm8									

```
d = UInt(Rd); n = UInt(Rn); setflags = (S == '1');
(imm32, carry) = ThumbExpandImmWithC(i:imm3:imm8, APSR.C);
if n == 15 then SEE MOV (immediate) on page A5-167;
if BadReg(d) || n == 13 then UNPREDICTABLE;
```

Architecture versions

Encoding T1 All versions of the Thumb instruction set from Thumb-2 onwards.

Assembler syntax

```
ORR{S}<c><q> {<Rd>}, <Rn>, #<const>
```

where:

- S If present, specifies that the instruction updates the flags. Otherwise, the instruction does not update the flags.
- <c><q> See *Standard assembler syntax fields* on page A5-6.
- <Rd> Specifies the destination register. If <Rd> is omitted, this register is the same as <Rn>.
- <Rn> Specifies the register that contains the operand.
- <const> Specifies the immediate value to be added to the value obtained from <Rn>. See *Immediate constants* on page A5-8 for the range of allowed values.

The pre-UAL syntax ORR<c>S is equivalent to ORRS<c>.

Operation

```
if ConditionPassed() then
    EncodingSpecificOperations();
    result = R[n] OR imm32;
    R[d] = result;
    if setflags then
        APSR.N = result<31>;
        APSR.Z = IsZeroBit(result);
        APSR.C = carry;
        // APSR.V unchanged
```

Exceptions

None.

A5.7.90 ORR (register)

Logical OR (register) performs a bitwise (inclusive) OR of a register value and an optionally-shifted register value, and writes the result to the destination register. It can optionally update the condition flags based on the result.

Encodings

T1 ORRS <Rdn>, <Rm> Outside IT block.
 ORR<c> <Rdn>, <Rm> Inside IT block.

15	14	13	12	11	10	9	8	7	6	5	4	3	2	1	0
0 1 0 0 0 0						1 1 0 0			Rm			Rdn			

```
d = UInt(Rdn); n = UInt(Rdn); m = UInt(Rm); setflags = !InITBlock();
(shift_t, shift_n) = (SRTType_None, 0);
```

T2 ORR{S}<c>.W <Rd>, <Rn>, <Rm>{, <shift>}

15	14	13	12	11	10	9	8	7	6	5	4	3	2	1	0	15	14	13	12	11	10	9	8	7	6	5	4	3	2	1	0				
1		1		1		0		1		0		0		1		0		S		Rn			(0)		imm3			Rd		imm2		type		Rm	

```
d = UInt(Rd); n = UInt(Rn); m = UInt(Rm); setflags = (S == '1');
(shift_t, shift_n) = DecodeImmShift(type, imm3:imm2);
if n == 15 then SEE MOV (register) on page A5-169;
if BadReg(d) || n == 13 || BadReg(m) THEN UNPREDICTABLE;
```

Architecture versions

Encoding T1 All versions of the Thumb instruction set

Encoding T2 All versions of the Thumb instruction set from Thumb-2 onwards.

Assembler syntax

```
ORR{S}<c><q> {<Rd>,<Rn>,<Rm> {,<shift>}}
```

where:

- S If present, specifies that the instruction updates the flags. Otherwise, the instruction does not update the flags.
- <c><q> See *Standard assembler syntax fields* on page A5-6.
- <Rd> Specifies the destination register. If <Rd> is omitted, this register is the same as <Rn>.
- <Rn> Specifies the register that contains the first operand.
- <Rm> Specifies the register that is optionally shifted and used as the second operand.
- <shift> Specifies the shift to apply to the value read from <Rm>. If <shift> is omitted, no shift is applied and both encodings are permitted. If <shift> is specified, only encoding T2 is permitted. The possible shifts and how they are encoded are described in *Constant shifts applied to a register* on page A5-10.

A special case is that if ORR<c> <Rd>,<Rn>,<Rd> is written with <Rd> and <Rn> both in the range R0-R7, it will be assembled using encoding T2 as though ORR<c> <Rd>,<Rn> had been written. To prevent this happening, use the .W qualifier.

The pre-UAL syntax ORR<c>S is equivalent to ORRS<c>.

Operation

```
if ConditionPassed() then
    EncodingSpecificOperations();
    (shifted, carry) = Shift_C(R[m], shift_t, shift_n, APSR.C);
    result = R[n] OR shifted;
    R[d] = result;
    if setflags then
        APSR.N = result<31>;
        APSR.Z = IsZeroBit(result);
        APSR.C = carry;
        // APSR.V unchanged
```

Exceptions

None.

A5.7.91 PLD (immediate)

Preload Data signals the memory system that data memory accesses from a specified address are likely in the near future. The memory system can respond by taking actions that are expected to speed up the memory accesses when they do occur, such as pre-loading the cache line containing the specified address into the data cache.

Encodings

T1 PLD<c> [<Rn>, #<imm12>]

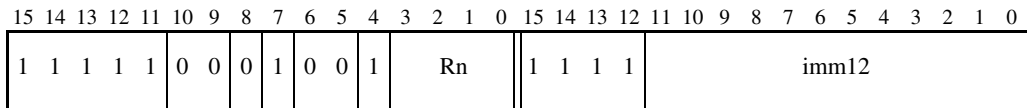

```
n = UInt(Rn); imm32 = ZeroExtend(imm12, 32); add = TRUE;
if n == 15 then SEE encoding T3;
```

T2 PLD<c> [<Rn>, #-<imm8>]

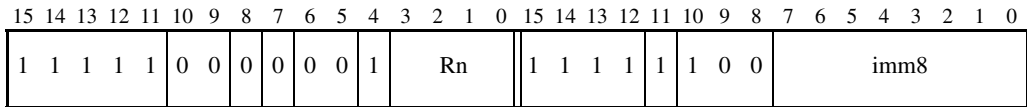

```
n = UInt(Rn); imm32 = ZeroExtend(imm8, 32); add = FALSE;
if n == 15 then SEE encoding T3;
```

T3 PLD<c> [PC, #+/-<imm12>]

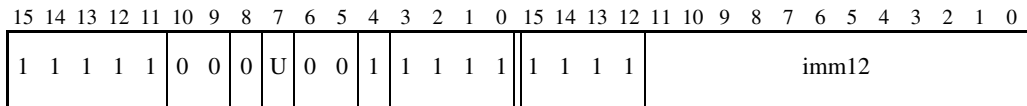

```
n = 15; imm32 = ZeroExtend(imm12, 32); add = (U == '1');
```

Architecture versions**Encodings T1, T2, T3**

All versions of the Thumb instruction set from Thumb-2 onwards.

Assembler syntax

PLD<c><q> [*<Rn>*, #+/-<i>imm>]

PLD<c><q> [PC, #+/-<i>imm>]

where:

<c><q> See *Standard assembler syntax fields* on page A5-6.

<Rn> Is the base register. This register is allowed to be the SP.

+/- Is + or omitted to indicate that the immediate offset is added to the base register value (`add == TRUE`), or – to indicate that the offset is to be subtracted (`add == FALSE`). Different instructions are generated for #0 and #-0.

<imm> Specifies the offset from the base register. It must be in the range:

- –4095 to 4095 if the base register is the PC
- –255 to 4095 otherwise.

Operation

```
if ConditionPassed() then
    EncodingSpecificOperations();
    base = if n == 15 then Align(PC,4) else R[n];
    address = if add then (base + imm32) else (base - imm32);
    Hint_PreloadData(address);
```

Exceptions

None.

A5.7.92 PLD (register)

Preload Data signals the memory system that data memory accesses from a specified address are likely in the near future. The memory system can respond by taking actions that are expected to speed up the memory accesses when they do occur, such as pre-loading the cache line containing the specified address into the data cache.

Encodings

T1 PLD<c> [<Rn>, <Rm>{, LSL #<shift>}]

15	14	13	12	11	10	9	8	7	6	5	4	3	2	1	0	15	14	13	12	11	10	9	8	7	6	5	4	3	2	1	0
1	1	1	1	1	0	0	0	0	0	0	1	Rn				1	1	1	1	0	0	0	0	0	0	shift	Rm				

```
n = UInt(Rn); m = UInt(Rm);
(shift_t, shift_n) = (SRTYPE_LSL, UInt(shift));
if n == 15 then SEE PLD (immediate) on page A5-198;
if BadReg(m) then UNPREDICTABLE;
```

Architecture versions

Encoding T1 All versions of the Thumb instruction set from Thumb-2 onwards.

Assembler syntax

```
PLD<c><q> [<Rn>, <Rm> {, LSL #<shift>}]
```

where:

- <c><q> See *Standard assembler syntax fields* on page A5-6.
- <Rn> Is the base register. This register is allowed to be the SP.
- <Rm> Is the optionally shifted offset register.
- <shift> Specifies the shift to apply to the value read from <Rm>, in the range 0-3. If this option is omitted, a shift by 0 is assumed.

Operation

```
if ConditionPassed() then
    EncodingSpecificOperations();
    address = R[n] + Shift(R[m], shift_t, shift_n, APSR.C);
    Hint_PreloadData(address);
```

Exceptions

None.

A5.7.93 PLI (immediate)

Preload Instruction signals the memory system that instruction memory accesses from a specified address are likely in the near future. The memory system can respond by taking actions that are expected to speed up the memory accesses when they do occur, such as pre-loading the cache line containing the specified address into the instruction cache.

Encodings

T1 PLI<c> [<Rn>, #<imm12>]

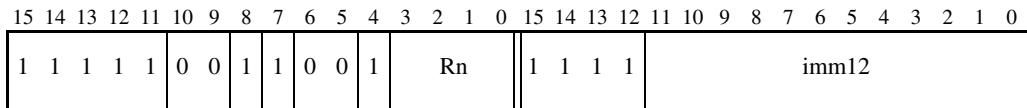

```
n = UInt(Rn); imm32 = ZeroExtend(imm12, 32); add = TRUE;
if n == 15 then SEE encoding T3;
```

T2 PLI<c> [<Rn>, #-<imm8>]

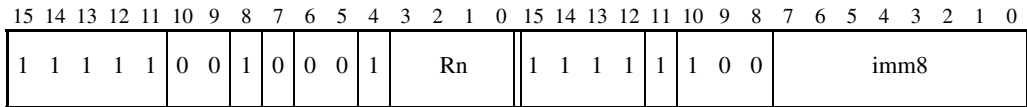

```
n = UInt(Rn); imm32 = ZeroExtend(imm8, 32); add = FALSE;
if n == 15 then SEE encoding T3;
```

T3 PLI<c> [PC, #+/-<imm12>]

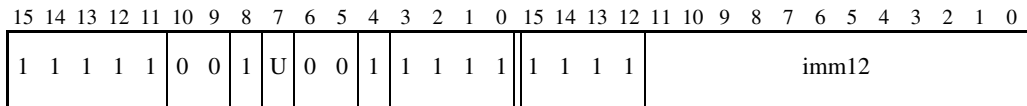

```
n = 15; imm32 = ZeroExtend(imm12, 32); add = (U == '1');
```

Architecture versions**Encodings T1, T2, T3**

All versions of the Thumb instruction set from v7 onwards.

Assembler syntax

```
PLI<c><q> [<Rn>, #+/-<imm>]
PLI<c><q> [PC, #+/-<imm>]
```

where:

- <c><q> See *Standard assembler syntax fields* on page A5-6.
- <Rn> Is the base register. This register is allowed to be the SP.
- +/- Is + or omitted to indicate that the immediate offset is added to the base register value (`add == TRUE`), or – to indicate that the offset is to be subtracted (`add == FALSE`). Different instructions are generated for #0 and #-0.
- <imm> Specifies the offset from the base register. It must be in the range:
- –4095 to 4095 if the base register is the PC
 - –255 to 4095 otherwise.

Operation

```
if ConditionPassed() then
    EncodingSpecificOperations();
    base = if n == 15 then Align(PC,4) else R[n];
    address = if add then (base + imm32) else (base - imm32);
    Hint_PreloadInstr(address);
```

Exceptions

None.

A5.7.94 PLI (register)

Preload Instruction signals the memory system that instruction memory accesses from a specified address are likely in the near future. The memory system can respond by taking actions that are expected to speed up the memory accesses when they do occur, such as pre-loading the cache line containing the specified address into the instruction cache.

Encodings

T1 PLI<c> [<Rn>, <Rm>{, LSL #<shift>}]

15	14	13	12	11	10	9	8	7	6	5	4	3	2	1	0	15	14	13	12	11	10	9	8	7	6	5	4	3	2	1	0
1	1	1	1	1	0	0	1	0	0	0	1	Rn				1	1	1	1	0	0	0	0	0	0	shift	Rm				

```
n = UInt(Rn); m = UInt(Rm);
(shift_t, shift_n) = (SRTYPE_LSL, UInt(shift));
if n == 15 then SEE PLI (immediate) on page A5-202;
if BadReg(m) then UNPREDICTABLE;
```

Architecture versions

Encodings T1, T2 All versions of the Thumb instruction set from v7 onwards.

Assembler syntax

```
PLI<c><q> [<Rn>, <Rm> {, LSL #<shift>}]
```

where:

- <c><q> See *Standard assembler syntax fields* on page A5-6.
- <Rn> Is the base register. This register is allowed to be the SP.
- <Rm> Is the optionally shifted offset register.
- <shift> Specifies the shift to apply to the value read from <Rm>, in the range 0-3. If this option is omitted, a shift by 0 is assumed.

Operation

```
if ConditionPassed() then
    EncodingSpecificOperations();
    address = R[n] + Shift(R[m], shift_t, shift_n, APSR.C);
    Hint_PreloadInstr(address);
```

Exceptions

None.

A5.7.95 POP

Pop Multiple Registers loads a subset (or possibly all) of the general-purpose registers R0-R12 and the PC or the LR from the stack.

If the registers loaded include the PC, the word loaded for the PC is treated as an address or an exception return value and a branch occurs. Bit[0] complies with the ARM architecture interworking rules for branches to Thumb state execution and must be 1. If bit[0] is 0, a UsageFault exception occurs.

Encoding

T1 POP<c> <registers>

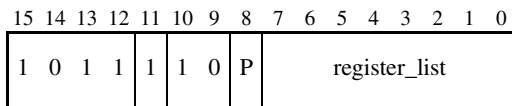

```
registers = P:'0000000':register_list;
if BitCount(registers) < 1 then UNPREDICTABLE;
```

T2 POP<c>.W <registers>

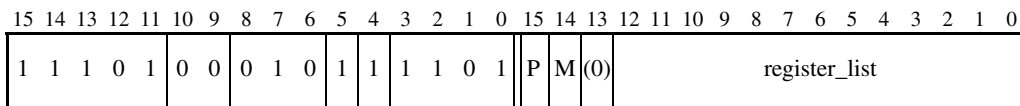

```
registers = P:M:'0':register_list;
if BitCount(registers) < 2 then UNPREDICTABLE;
if P == 1 && M == 1 then UNPREDICTABLE;
```

Architecture versions

Encoding T1 All versions of the Thumb instruction set.

Encoding T2 All versions of the Thumb instruction set from Thumb-2 onwards.

Assembler syntax

POP<c><q> <registers> Standard syntax
 LDMIA<c><q> SP!, <registers> Equivalent LDM syntax

where:

<c><q> See *Standard assembler syntax fields* on page A5-6.

<registers>

Is a list of one or more registers, separated by commas and surrounded by { and }. It specifies the set of registers to be loaded. The registers are loaded in sequence, the lowest-numbered register from the lowest memory address, through to the highest-numbered register from the highest memory address. If the PC is specified in the register list, the instruction causes a branch to the address (data) loaded into the PC.

Encoding T2 does not support a list containing only one register. If a POP instruction with just one register <Rt> in the list is assembled to Thumb and encoding T1 is not available, it is assembled to the equivalent LDR<c><q> <Rt>, [SP], #-4 instruction.

The SP cannot be in the list.

If the PC is in the list, the LR must not be in the list.

Operation

```
if ConditionPassed() then
    EncodingSpecificOperations();
    originalSP = SP;
    address = SP;
    SP = SP + 4*BitCount(registers);
    for i = 0 to 14
        if registers<i> == '1' then
            loadedvalue = MemA[address,4];
            address = address + 4;
    if registers<15> == '1' then
        LoadWritePC(MemA[address,4]);
        address = address + 4;
    assert address == originalSP + 4*BitCount(registers);
```

Exceptions

UsageFault, MemManage, BusFault.

A5.7.96 PUSH

Push Multiple Registers stores a subset (or possibly all) of the general-purpose registers R0-R12 and the LR to the stack.

Encoding

T1 PUSH<c> <registers>

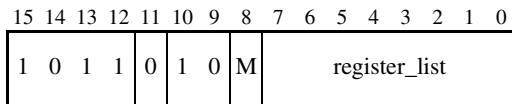

```
registers = '0':M:'000000':register_list;
if BitCount(registers) < 1 then UNPREDICTABLE;
```

T2 PUSH<c>.W <registers>

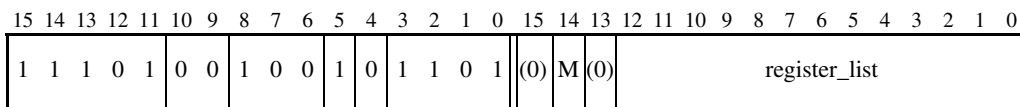

```
registers = '0':M:'0':register_list;
if BitCount(registers) < 2 then UNPREDICTABLE;
```

Architecture versions

Encoding T1 All versions of the Thumb instruction set.

Encoding T2 All versions of the Thumb instruction set from Thumb-2 onwards.

Assembler syntax

PUSH<c><q> <registers>	Standard syntax
STMDB<c><q> SP!, <registers>	Equivalent STM syntax

where:

<c><q> See *Standard assembler syntax fields* on page A5-6.

<registers>

Is a list of one or more registers, separated by commas and surrounded by { and }. It specifies the set of registers to be stored. The registers are stored in sequence, the lowest-numbered register to the lowest memory address, through to the highest-numbered register to the highest memory address.

Encoding T2 does not support a list containing only one register. If a PUSH instruction with just one register <Rt> in the list is assembled to Thumb and encoding T1 is not available, it is assembled to the equivalent STR<c><q> <Rt>, [SP, #-4]! instruction.

The SP and PC cannot be in the list.

Operation

```

if ConditionPassed() then
    EncodingSpecificOperations();
    originalSP = SP;
    address = SP - 4*BitCount(registers);
    SP = SP - 4*BitCount(registers);
    for i = 0 to 14
        if registers<i> == '1' then
            MemA[address,4] = R[i];
            address = address + 4;
    assert address == originalSP;

```

Exceptions

UsageFault, MemManage, BusFault.

A5.7.97 RBIT

Reverse Bits reverses the bit order in a 32-bit register.

Encodings

T1 RBIT<c> <Rd>, <Rm>

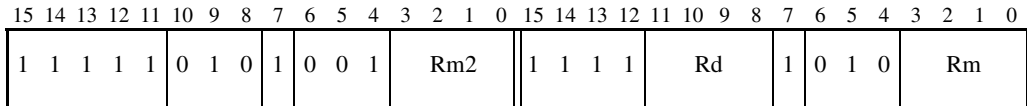

```
d = UInt(Rd); m = UInt(Rm); m2 = UInt(Rm2);
if BadReg(d) || BadReg(m) || m2 != m then UNPREDICTABLE;
```

Architecture versions

Encoding T1 All versions of the Thumb instruction set from Thumb-2 onwards.

Assembler syntax

RBIT<c><q> <Rd>, <Rm>

where:

<c><q> See *Standard assembler syntax fields* on page A5-6.

<Rd> Specifies the destination register.

<Rm> Specifies the register that contains the operand. Its number must be encoded twice in encoding T1, in both the Rm and Rm2 fields.

Operation

```
if ConditionPassed() then
    EncodingSpecificOperations();
    bits(32) result;
    for i = 0 to 31 do
        result<31-i> = R[m]<i>;
    R[d] = result;
```

Exceptions

None.

A5.7.98 REV

Byte-Reverse Word reverses the byte order in a 32-bit register.

Encodings

T1 REV<C> <Rd>, <Rm>

15	14	13	12	11	10	9	8	7	6	5	4	3	2	1	0
1	0	1	1	1	0	1	0	0	0	Rm				Rd	

d = UInt(Rd); m = UInt(Rm);

T2 REV<C>.W <Rd>, <Rm>

15	14	13	12	11	10	9	8	7	6	5	4	3	2	1	0	15	14	13	12	11	10	9	8	7	6	5	4	3	2	1	0
1	1	1	1	1	1	0	1	0	1	0	0	1	Rm2			1	1	1	1			Rd		1	0	0	0			Rm	

d = UInt(Rd); m = UInt(Rm); m2 = UInt(Rm2);
 if BadReg(d) || BadReg(m) || m2 != m then UNPREDICTABLE;

Architecture versions

Encoding T1 All versions of the Thumb instruction set from ARMv6 onwards.

Encoding T2 All versions of the Thumb instruction set from Thumb-2 onwards.

Assembler syntax

REV<c><q> <Rd>, <Rm>

where:

<c><q> See *Standard assembler syntax fields* on page A5-6.

<Rd> Specifies the destination register.

<Rm> Specifies the register that contains the operand. Its number must be encoded twice in encoding T2, in both the Rm and Rm2 fields.

Operation

```
if ConditionPassed() then
    EncodingSpecificOperations();
    bits(32) result;
    result<31:24> = R[m]<7:0>;
    result<23:16> = R[m]<15:8>;
    result<15:8>  = R[m]<23:16>;
    result<7:0>  = R[m]<31:24>;
    R[d] = result;
```

Exceptions

None.

A5.7.99 REV16

Byte-Reverse Packed Halfword reverses the byte order in each 16-bit halfword of a 32-bit register.

Encodings

T1 REV16<c> <Rd>, <Rm>

15	14	13	12	11	10	9	8	7	6	5	4	3	2	1	0
1	0	1	1	1	0	1	0	0	1	Rm				Rd	

d = UInt(Rd); m = UInt(Rm);

T2 REV16<c>.W <Rd>, <Rm>

15	14	13	12	11	10	9	8	7	6	5	4	3	2	1	0	15	14	13	12	11	10	9	8	7	6	5	4	3	2	1	0
1	1	1	1	1	0	1	0	1	0	0	1	Rm2				1	1	1	1		Rd		1	0	0	1		Rm			

d = UInt(Rd); m = UInt(Rm); m2 = UInt(Rm2);
 if BadReg(d) || BadReg(m) || m2 != m then UNPREDICTABLE;

Architecture versions

Encoding T1 All versions of the Thumb instruction set from ARMv6 onwards.

Encoding T2 All versions of the Thumb instruction set from Thumb-2 onwards.

Assembler syntax

REV16<c><q> <Rd>, <Rm>

where:

<c><q> See *Standard assembler syntax fields* on page A5-6.

<Rd> Specifies the destination register.

<Rm> Specifies the register that contains the operand. Its number must be encoded twice in encoding T2, in both the Rm and Rm2 fields.

Operation

```
if ConditionPassed() then
    EncodingSpecificOperations();
    bits(32) result;
    result<31:24> = R[m]<23:16>;
    result<23:16> = R[m]<31:24>;
    result<15:8>  = R[m]<7:0>;
    result<7:0>  = R[m]<15:8>;
    R[d] = result;
```

Exceptions

None.

A5.7.100 REVSH

Byte-Reverse Signed Halfword reverses the byte order in the lower 16-bit halfword of a 32-bit register, and sign extends the result to 32 bits.

Encodings

T1 REVSH<c> <Rd>, <Rm>

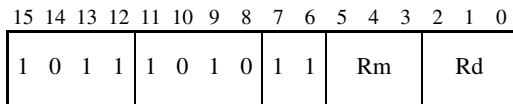

$d = \text{UInt}(Rd); \quad m = \text{UInt}(Rm);$

T2 REVSH<c>.W <Rd>, <Rm>

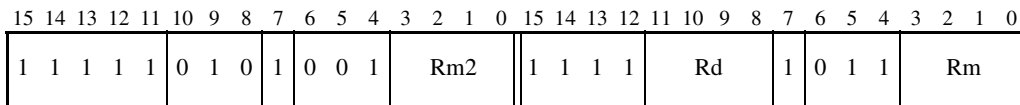

$d = \text{UInt}(Rd); \quad m = \text{UInt}(Rm); \quad m2 = \text{UInt}(Rm2);$
 if BadReg(d) || BadReg(m) || m2 != m then UNPREDICTABLE;

Architecture versions

Encoding T1 All versions of the Thumb instruction set from ARMv6 onwards.

Encoding T2 All versions of the Thumb instruction set from Thumb-2 onwards.

Assembler syntax

REVSH<c><q> <Rd>, <Rm>

where:

<c><q> See *Standard assembler syntax fields* on page A5-6.

<Rd> Specifies the destination register.

<Rm> Specifies the register that contains the operand. Its number must be encoded twice in encoding T2, in both the Rm and Rm2 fields.

Operation

```
if ConditionPassed() then
    EncodingSpecificOperations();
    bits(32) result;
    result<31:8> = SignExtend(R[m]<7:0>, 24);
    result<7:0> = R[m]<15:8>;
    R[d] = result;
```

Exceptions

None.

A5.7.101 ROR (immediate)

Rotate Right (immediate) provides the value of the contents of a register rotated by a constant value. The bits that are rotated off the right end are inserted into the vacated bit positions on the left. It can optionally update the condition flags based on the result.

Encodings

T1 ROR{S}<c> <Rd>, <Rm>, #<imm5>

15	14	13	12	11	10	9	8	7	6	5	4	3	2	1	0	15	14	13	12	11	10	9	8	7	6	5	4	3	2	1	0
1	1	1	0	1	0	1	0	0	1	0	S	1	1	1	1	(0)	imm3			Rd			imm2		1 1		Rm				

```
d = UInt(Rd); m = UInt(Rm); setflags = (S == '1');
if imm3:imm2 == '00000' then SEE RRX on page A5-222;
(-, shift_n) = DecodeImmShift('11', imm3:imm2);
if BadReg(d) || BadReg(m) THEN UNPREDICTABLE;
```

Architecture versions

Encoding T1 All versions of the Thumb instruction set from Thumb-2 onwards.

Assembler syntax

```
ROR{S}<c><q> <Rd>, <Rm>, #<imm5>
```

where:

S	If present, specifies that the instruction updates the flags. Otherwise, the instruction does not update the flags.
<c><q>	See <i>Standard assembler syntax fields</i> on page A5-6.
<Rd>	Specifies the destination register.
<Rm>	Specifies the register that contains the first operand.
<imm5>	Specifies the shift amount, in the range 1 to 31. See <i>Constant shifts applied to a register</i> on page A5-10.

Operation

```
if ConditionPassed() then
    EncodingSpecificOperations();
    (result, carry) = Shift_C(R[m], SRTYPE_ROR, shift_n, APSR.C);
    R[d] = result;
    if setflags then
        APSR.N = result<31>;
        APSR.Z = IsZeroBit(result);
        APSR.C = carry;
        // APSR.V unchanged
```

Exceptions

None.

A5.7.102 ROR (register)

Rotate Right (register) provides the value of the contents of a register rotated by a variable number of bits. The bits that are rotated off the right end are inserted into the vacated bit positions on the left. The variable number of bits is read from the bottom byte of a register. It can optionally update the condition flags based on the result.

Encodings

T1 RORS <Rdn>, <Rm> Outside IT block.
 ROR<c> <Rdn>, <Rm> Inside IT block.

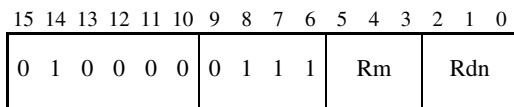

```
d = UInt(Rdn); n = UInt(Rdn); m = UInt(Rm); setflags = !InITBlock();
```

T2 ROR{S}<c>.W <Rd>, <Rn>, <Rm>

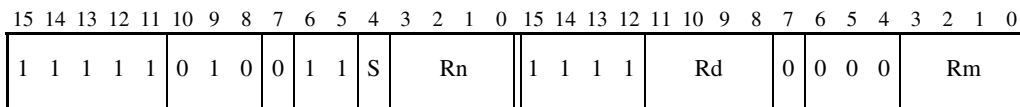

```
d = UInt(Rd); n = UInt(Rn); m = UInt(Rm); setflags = (S == '1');
if BadReg(d) || BadReg(n) || BadReg(m) then UNPREDICTABLE;
```

Architecture versions

Encoding T1 All versions of the Thumb instruction set

Encoding T2 All versions of the Thumb instruction set from Thumb-2 onwards.

Assembler syntax

ROR{S}<c><q> <Rd>, <Rn>, <Rm>

where:

S	If present, specifies that the instruction updates the flags. Otherwise, the instruction does not update the flags.
<c><q>	See <i>Standard assembler syntax fields</i> on page A5-6.
<Rd>	Specifies the destination register.
<Rn>	Specifies the register that contains the first operand.
<Rm>	Specifies the register whose bottom byte contains the amount to rotate by.

Operation

```

if ConditionPassed() then
    EncodingSpecificOperations();
    shift_n = UInt(R[m]<7:0>);
    (result, carry) = Shift_C(R[n], SRType_ROR, shift_n, APSR.C);
    R[d] = result;
    if setflags then
        APSR.N = result<31>;
        APSR.Z = IsZeroBit(result);
        APSR.C = carry;
        // APSR.V unchanged

```

Exceptions

None.

A5.7.103 RRX

Rotate Right with Extend provides the value of the contents of a register shifted right by one place, with the carry flag shifted into bit[31].

RRX can optionally update the condition flags based on the result. In that case, bit[0] is shifted into the carry flag.

Encodings

T1 RRX{S}<c> <Rd>, <Rm>

15	14	13	12	11	10	9	8	7	6	5	4	3	2	1	0	15	14	13	12	11	10	9	8	7	6	5	4	3	2	1	0
1	1	1	0	1	0	1	0	0	1	0	S	1	1	1	1	(0)	0	0	0	Rd	0	0	1	1	Rm						

```
d = UInt(Rd); m = UInt(Rm); setflags = (S == '1');
if BadReg(d) || BadReg(m) THEN UNPREDICTABLE;
```

Architecture versions

Encoding T1 All versions of the Thumb instruction set from Thumb-2 onwards.

Assembler syntax

```
RRX{S}<c><q> <Rd>, <Rm>
```

where:

- S If present, specifies that the instruction updates the flags. Otherwise, the instruction does not update the flags.
- <c><q> See *Standard assembler syntax fields* on page A5-6.
- <Rd> Specifies the destination register.
- <Rm> Specifies the register that contains the operand.

Operation

```
if ConditionPassed() then
    EncodingSpecificOperations();
    (result, carry) = Shift_C(R[m], SRTYPE_RRX, 1, APSR.C);
    R[d] = result;
    if setflags then
        APSR.N = result<31>;
        APSR.Z = IsZeroBit(result);
        APSR.C = carry;
        // APSR.V unchanged
```

Exceptions

None.

A5.7.104 RSB (immediate)

Reverse Subtract (immediate) subtracts a register value from an immediate value, and writes the result to the destination register. It can optionally update the condition flags based on the result.

Encodings

T1 RSBS <Rd>, <Rn>, #0 Outside IT block.
 RSB<c> <Rd>, <Rn>, #0 Inside IT block.

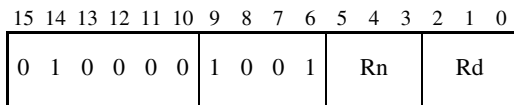

```
d = UInt(Rd); n = UInt(Rn); setflags = !InITBlock();
imm32 = ZeroExtend('0', 32); // Implicit zero immediate
```

T2 RSB{S}<c>.W <Rd>, <Rn>, #<const>

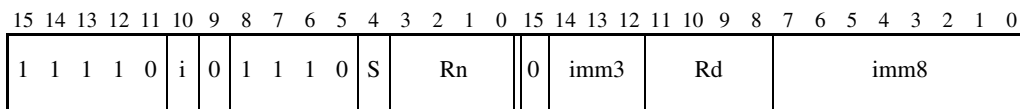

```
d = UInt(Rd); n = UInt(Rn); setflags = (S == '1');
imm32 = ThumbExpandImm(i:imm3:imm8);
if BadReg(d) || BadReg(n) then UNPREDICTABLE;
```

Architecture versions

Encoding T1 All versions of the Thumb instruction set.

Encoding T2 All versions of the Thumb instruction set from Thumb-2 onwards.

Assembler syntax

```
RSB{S}<c><q> {<Rd>}, <Rn>, #<const>
```

where:

- S If present, specifies that the instruction updates the flags. Otherwise, the instruction does not update the flags.
- <c><q> See *Standard assembler syntax fields* on page A5-6.
- <Rd> Specifies the destination register. If <Rd> is omitted, this register is the same as <Rn>.
- <Rn> Specifies the register that contains the first operand.
- <const> Specifies the immediate value to be added to the value obtained from <Rn>. The only allowed value for encoding T1 is 0. See *Immediate constants* on page A5-8 for the range of allowed values for encoding T2.

The pre-UAL syntax RSB<c>S is equivalent to RSBS<c>.

Operation

```
if ConditionPassed() then
    EncodingSpecificOperations();
    (result, carry, overflow) = AddWithCarry(NOT(R[n]), imm32, '1');
    R[d] = result;
    if setflags then
        APSR.N = result<31>;
        APSR.Z = IsZeroBit(result);
        APSR.C = carry;
        APSR.V = overflow;
```

Exceptions

None.

A5.7.105 RSB (register)

Reverse Subtract (register) subtracts a register value from an optionally-shifted register value, and writes the result to the destination register. It can optionally update the condition flags based on the result.

Encodings

T1 RSB{S}<c> <Rd>, <Rn>, <Rm>{, <shift>}

15	14	13	12	11	10	9	8	7	6	5	4	3	2	1	0	15	14	13	12	11	10	9	8	7	6	5	4	3	2	1	0
1	1	1	0	1	0	1	1	1	0	S	Rn	(0)	imm3	Rd	imm2	type	Rm														

```
d = UInt(Rd); n = UInt(Rn); m = UInt(Rm); setflags = (S == '1');
(shift_t, shift_n) = DecodeImmShift(type, imm3:imm2);
if BadReg(d) || BadReg(n) || BadReg(m) THEN UNPREDICTABLE;
```

Architecture versions

Encoding T1 All versions of the Thumb instruction set from Thumb-2 onwards.

Assembler syntax

```
RSB{S}<c><q> {<Rd>,<Rn>,<Rm> {,<shift>}}
```

where:

S	If present, specifies that the instruction updates the flags. Otherwise, the instruction does not update the flags.
<c><q>	See <i>Standard assembler syntax fields</i> on page A5-6.
<Rd>	Specifies the destination register. If <Rd> is omitted, this register is the same as <Rn>.
<Rn>	Specifies the register that contains the first operand.
<Rm>	Specifies the register that is optionally shifted and used as the second operand.
<shift>	Specifies the shift to apply to the value read from <Rm>. If <shift> is omitted, no shift is applied. The possible shifts and how they are encoded are described in <i>Constant shifts applied to a register</i> on page A5-10.

The pre-UAL syntax RSB<c>S is equivalent to RSBS<c>.

Operation

```
if ConditionPassed() then
    EncodingSpecificOperations();
    shifted = Shift(R[m], shift_t, shift_n, APSR.C);
    (result, carry, overflow) = AddWithCarry(NOT(R[n]), shifted, '1');
    R[d] = result;
    if setflags then
        APSR.N = result<31>;
        APSR.Z = IsZeroBit(result);
        APSR.C = carry;
        APSR.V = overflow;
```

Exceptions

None.

A5.7.106 SBC (immediate)

Subtract with Carry (immediate) subtracts an immediate value and the value of NOT(Carry flag) from a register value, and writes the result to the destination register. It can optionally update the condition flags based on the result.

Encodings

T1 SBC{S}<c> <Rd>, <Rn>, #<const>

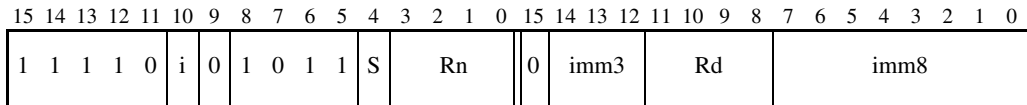

```
d = UInt(Rd); n = UInt(Rn); setflags = (S == '1');
imm32 = ThumbExpandImm(i:imm3:imm8);
if BadReg(d) || BadReg(n) then UNPREDICTABLE;
```

Architecture versions

Encoding T1 All versions of the Thumb instruction set from Thumb-2 onwards.

Assembler syntax

```
SBC{S}<c><q> {<Rd>}, <Rn>, #<const>
```

where:

- S If present, specifies that the instruction updates the flags. Otherwise, the instruction does not update the flags.
- <c><q> See *Standard assembler syntax fields* on page A5-6.
- <Rd> Specifies the destination register. If <Rd> is omitted, this register is the same as <Rn>.
- <Rn> Specifies the register that contains the first operand.
- <const> Specifies the immediate value to be added to the value obtained from <Rn>. See *Immediate constants* on page A5-8 for the range of allowed values.

The pre-UAL syntax SBC<c>S is equivalent to SBCS<c>.

Operation

```
if ConditionPassed() then
    EncodingSpecificOperations();
    (result, carry, overflow) = AddWithCarry(R[n], NOT(imm32), APSR.C);
    R[d] = result;
    if setflags then
        APSR.N = result<31>;
        APSR.Z = IsZeroBit(result);
        APSR.C = carry;
        APSR.V = overflow;
```

Exceptions

None.

A5.7.107 SBC (register)

Subtract with Carry (register) subtracts an optionally-shifted register value and the value of NOT(Carry flag) from a register value, and writes the result to the destination register. It can optionally update the condition flags based on the result.

Encodings

T1 SBCS <Rdn>, <Rm> Outside IT block.
 SBC<c> <Rdn>, <Rm> Inside IT block.

15	14	13	12	11	10	9	8	7	6	5	4	3	2	1	0
0 1 0 0 0 0						0 1 1 0			Rm		Rdn				

```
d = UInt(Rdn); n = UInt(Rdn); m = UInt(Rm); setflags = !InITBlock();
(shift_t, shift_n) = (SRTType_None, 0);
```

T2 SBC{S}<c>.W <Rd>, <Rn>, <Rm>{, <shift>}

15	14	13	12	11	10	9	8	7	6	5	4	3	2	1	0	15	14	13	12	11	10	9	8	7	6	5	4	3	2	1	0
1		1		1		0		1		0		1		1		S	Rn		(0)		imm3		Rd		imm2		type		Rm		

```
d = UInt(Rd); n = UInt(Rn); m = UInt(Rm); setflags = (S == '1');
(shift_t, shift_n) = DecodeImmShift(type, imm3:imm2);
if BadReg(d) || BadReg(n) || BadReg(m) THEN UNPREDICTABLE;
```

Architecture versions

Encoding T1 All versions of the Thumb instruction set

Encoding T2 All versions of the Thumb instruction set from Thumb-2 onwards.

Assembler syntax

```
SBC{S}<c><q> {<Rd>,<Rn>,<Rm> {,<shift>}}
```

where:

S	If present, specifies that the instruction updates the flags. Otherwise, the instruction does not update the flags.
<c><q>	See <i>Standard assembler syntax fields</i> on page A5-6.
<Rd>	Specifies the destination register. If <Rd> is omitted, this register is the same as <Rn>.
<Rn>	Specifies the register that contains the first operand.
<Rm>	Specifies the register that is optionally shifted and used as the second operand.
<shift>	Specifies the shift to apply to the value read from <Rm>. If <shift> is omitted, no shift is applied and both encodings are permitted. If <shift> is specified, only encoding T2 is permitted. The possible shifts and how they are encoded are described in <i>Constant shifts applied to a register</i> on page A5-10.

The pre-UAL syntax SBC<c>S is equivalent to SBCS<c>.

Operation

```
if ConditionPassed() then
    EncodingSpecificOperations();
    shifted = Shift(R[m], shift_t, shift_n, APSR.C);
    (result, carry, overflow) = AddWithCarry(R[n], NOT(shifted), APSR.C);
    R[d] = result;
    if setflags then
        APSR.N = result<31>;
        APSR.Z = IsZeroBit(result);
        APSR.C = carry;
        APSR.V = overflow;
```

Exceptions

None.

A5.7.108 SBFX

Signed Bit Field Extract extracts any number of adjacent bits at any position from one register, sign extends them to 32 bits, and writes the result to the destination register.

Encodings

T1 SBFX<c> <Rd>, <Rn>, #<lsb>, #<width>

15	14	13	12	11	10	9	8	7	6	5	4	3	2	1	0	15	14	13	12	11	10	9	8	7	6	5	4	3	2	1	0
1	1	1	1	0	(0)	1	1	0	1	0	0	Rn				0	imm3			Rd		imm2		(0)	widthm1						

```
d = UInt(Rd); n = UInt(Rn);
lsbit = UInt(imm3:imm2); widthminus1 = UInt(widthm1);
if BadReg(d) || BadReg(n) then UNPREDICTABLE;
```

Architecture versions

Encoding T1 All versions of the Thumb instruction set from Thumb-2 onwards.

Assembler syntax

SBFX<c><q> <Rd>, <Rn>, #<lsb>, #<width>

where:

<c><q> See *Standard assembler syntax fields* on page A5-6.

<Rd> Specifies the destination register.

<Rn> Specifies the register that contains the first operand.

<lsb> is the bit number of the least significant bit in the bitfield, in the range 0-31. This determines the required value of `lsbit`.

<width> is the width of the bitfield, in the range 1 to 32-<lsb>. The required value of `widthminus1` is `<width>-1`.

Operation

```
if ConditionPassed() then
    EncodingSpecificOperations();
    msbit = lsbit + widthminus1;
    if msbit <= 31 then
        R[d] = SignExtend(R[n]<msbit:lsbit>, 32);
    else
        UNPREDICTABLE;
```

Exceptions

None.

A5.7.109 SDIV

Signed Divide divides a 32-bit signed integer register value by a 32-bit signed integer register value, and writes the result to the destination register. The condition code flags are not affected.

Encodings

T1 SDIV<c> <Rd>, <Rn>, <Rm>

15	14	13	12	11	10	9	8	7	6	5	4	3	2	1	0	15	14	13	12	11	10	9	8	7	6	5	4	3	2	1	0
1	1	1	1	1	0	1	1	1	0	0	1	Rn				(1)	(1)	(1)	(1)	Rd				1	1	1	1	Rm			

```
d = UInt(Rd); n = UInt(Rn); m = UInt(Rm);
if BadReg(d) || BadReg(n) || BadReg(m) then UNPREDICTABLE;
```

Architecture versions

Encoding T1 Specific profiles of ARMv7 onwards, including ARMv7-M

Assembler syntax

```
SDIV<c><q> {<Rd>, } <Rn>, <Rm>
```

where:

- <c><q> See *Standard assembler syntax fields* on page A5-6.
- <Rd> Specifies the destination register. If <Rd> is omitted, this register is the same as <Rn>.
- <Rn> Specifies the register that contains the dividend.
- <Rm> Specifies the register that contains the divisor.

Operation

```
if ConditionPassed() then
    EncodingSpecificOperations();
    if SInt(R[m]) == 0 then
        if IntegerZeroDivideTrappingEnabled() then
            RaiseIntegerZeroDivide();
        else
            result = 0;
    else
        result = RoundTowardsZero(SInt(R[n]) / SInt(R[m]));
    R[d] = result<31:0>;
```

Exceptions

UsageFault.

Notes

Overflow If the signed integer division $0x80000000 / 0xFFFFFFFF$ is performed, the pseudo-code produces the intermediate integer result $+2^{31}$, which overflows the 32-bit signed integer range. No indication of this overflow case is produced, and the 32-bit result written to $R[d]$ is required to be the bottom 32 bits of the binary representation of $+2^{31}$. So the result of the division is $0x80000000$.

A5.7.110 SEV

Send Event is a hint instruction. It causes an event to be signaled to all CPUs within the multiprocessor system.

This is a NOP-compatible hint, see *NOP-compatible hints* on page A5-15.

Encodings

T1 SEV<c>

15	14	13	12	11	10	9	8	7	6	5	4	3	2	1	0
1	0	1	1	1	1	1	1	0	1	0	0	0	0	0	0

// Do nothing

T2 SEV<c>.W

15	14	13	12	11	10	9	8	7	6	5	4	3	2	1	0	15	14	13	12	11	10	9	8	7	6	5	4	3	2	1	0
1	1	1	1	0	0	1	1	1	0	1	0	(1)	(1)	(1)	(1)	1	0	(0)	0	(0)	0	0	0	0	0	0	1	0	0		

// Do nothing

Architecture versions

Encodings T1, T2 All versions of the Thumb instruction set from v6K onwards.

Assembler syntax

SEV<c><q>

where:

<c><q> See *Standard assembler syntax fields* on page A5-6.

Operation

```
if ConditionPassed() then
    EncodingSpecificOperations();
    Hint_SendEvent();
```

Exceptions

None.

A5.7.111 SMLAL

Signed Multiply Accumulate Long multiplies two signed 32-bit values to produce a 64-bit value, and accumulates this with a 64-bit value.

Encodings

T1 SMLAL<c> <RdLo>, <RdHi>, <Rn>, <Rm>

15	14	13	12	11	10	9	8	7	6	5	4	3	2	1	0	15	14	13	12	11	10	9	8	7	6	5	4	3	2	1	0
1	1	1	1	1	0	1	1	1	1	0	0	Rn			RdLo			RdHi			0 0 0 0			Rm							

```
dLo = UInt(RdLo); dHi = UInt(RdHi); n = UInt(Rn); m = UInt(Rm);
if BadReg(dLo) || BadReg(dHi) || BadReg(n) || BadReg(m) then UNPREDICTABLE;
if dHi == dLo then UNPREDICTABLE;
```

Architecture versions

Encoding T1 All versions of the Thumb instruction set from Thumb-2 onwards.

Assembler syntax

SMLAL<c><q> <RdLo>, <RdHi>, <Rn>, <Rm>

where:

- <c><q> See *Standard assembler syntax fields* on page A5-6.
- <RdLo> Supplies the lower 32 bits of the accumulate value, and is the destination register for the lower 32 bits of the result.
- <RdHi> Supplies the upper 32 bits of the accumulate value, and is the destination register for the upper 32 bits of the result.
- <Rn> Specifies the register that contains the first operand.
- <Rm> Specifies the register that contains the second operand.

Operation

```
if ConditionPassed() then
    EncodingSpecificOperations();
    result = SInt(R[n])*SInt(R[m])+SInt(R[dHi]:R[dLo])
    R[dHi] = result<63:32>;
    R[dLo] = result<31:0>;
```

Exceptions

None.

A5.7.112 SMULL

Signed Multiply Long multiplies two 32-bit signed values to produce a 64-bit result.

Encodings

T1 SMULL<c> <RdLo>, <RdHi>, <Rn>, <Rm>

15	14	13	12	11	10	9	8	7	6	5	4	3	2	1	0	15	14	13	12	11	10	9	8	7	6	5	4	3	2	1	0
1	1	1	1	1	0	1	1	1	0	0	0	Rn			RdLo			RdHi			0	0	0	0	Rm						

```
dLo = UInt(RdLo); dHi = UInt(RdHi); n = UInt(Rn); m = UInt(Rm);
if BadReg(dLo) || BadReg(dHi) || BadReg(n) || BadReg(m) then UNPREDICTABLE;
if dHi == dLo then UNPREDICTABLE;
```

Architecture versions

Encoding T1 All versions of the Thumb instruction set from Thumb-2 onwards.

Assembler syntax

```
SMULL<c><q> <RdLo>, <RdHi>, <Rn>, <Rm>
```

where:

- <c><q> See *Standard assembler syntax fields* on page A5-6.
- <RdLo> Stores the lower 32 bits of the result.
- <RdHi> Stores the upper 32 bits of the result.
- <Rn> Specifies the register that contains the first operand.
- <Rm> Specifies the register that contains the second operand.

Operation

```
if ConditionPassed() then
    EncodingSpecificOperations();
    result = SInt(R[n]) * SInt(R[m]);
    R[dHi] = result<63:32>;
    R[dLo] = result<31:0>;
```

Exceptions

None.

A5.7.113 SSAT

Signed Saturate saturates an optionally-shifted signed value to a selectable signed range.

The Q flag is set if the operation saturates.

Encodings

T1 SSAT<c> <Rd>, #<imm>, <Rn>{, <shift>}

15	14	13	12	11	10	9	8	7	6	5	4	3	2	1	0	15	14	13	12	11	10	9	8	7	6	5	4	3	2	1	0
1	1	1	1	0	(0)	1	1	0	0	sh	0	Rn				0	imm3			Rd				imm2	(0)	sat_imm					

```
d = UInt(Rd); n = UInt(Rn); saturate_to = UInt(sat_imm)+1;
if sh == 1 && imm3:imm2 == '00000' then UNDEFINED;
(shift_t, shift_n) = DecodeImmShift(sh:'0', imm3:imm2);
if BadReg(d) || BadReg(n) then UNPREDICTABLE;
```

Architecture versions

Encoding T1 All versions of the Thumb instruction set from Thumb-2 onwards.

Assembler syntax

```
SSAT<c><q> <Rd>, #<imm>, <Rn> {,<shift>}
```

where:

<c><q> See *Standard assembler syntax fields* on page A5-6.

<Rd> Specifies the destination register.

<imm> Specifies the bit position for saturation, in the range 1 to 32.

<Rn> Specifies the register that contains the value to be saturated.

<shift> Specifies the optional shift. If present, it must be one of:

LSL #N

N must be in the range 0 to 31.

ASR #N

N must be in the range 1 to 31.

If <shift> is omitted, LSL #0 is used.

Operation

```
if ConditionPassed() then
    EncodingSpecificOperations();
    operand = Shift(R[n], shift_t, shift_n, APSR.C); // APSR.C ignored
    (result, sat) = SignedSatQ(SInt(operand), saturate_to);
    R[d] = SignExtend(result, 32);
    if sat then
        APSR.Q = '1';
```

Exceptions

None.

A5.7.114 STC, STC2

Store Coprocessor stores data from a coprocessor to a sequence of consecutive memory addresses.

If no coprocessor can execute the instruction, a UsageFault exception is generated.

Encoding

T1 STC{2}{L}<c> <coproc>, <CRd>, [<Rn>, #+/-<imm8>]
 STC{2}{L}<c> <coproc>, <CRd>, [<Rn>], #+/-<imm8>
 STC{2}{L}<c> <coproc>, <CRd>, [<Rn>, #+/-<imm8>!]
 STC{2}{L}<c> <coproc>, <CRd>, [<Rn>], <option>

15	14	13	12	11	10	9	8	7	6	5	4	3	2	1	0	15	14	13	12	11	10	9	8	7	6	5	4	3	2	1	0
1	1	1	C	1	1	0	P	U	N	W	0	Rn				CRd				coproc				imm8							

```
n = UInt(Rn); cp = UInt(coproc); imm32 = ZeroExtend(imm8:'00', 32);
opc1 = N; opc0 = C; // STC if C == '0', STC2 if C == '1'
index = (P == '1'); add = (U == '1'); wback = (W == '1');
if P == '0' && U == '0' && N == '0' && W == '0' then UNDEFINED;
if P == '0' && U == '0' && N == '1' && W == '0' then
    SEE MCRR, MCRR2 on page A5-161;
if n == 15 && wback then UNPREDICTABLE;
```

Architecture versions

Encoding T1 All versions of the Thumb instruction set from Thumb-2 onwards.

Assembler syntax

STC{2}{L}<c><q> <coproc>, <CRd>, [<Rn>{, #+/-<imm>}]	index==TRUE, wback==FALSE
STC{2}{L}<c><q> <coproc>, <CRd>, [<Rn>, #+/-<imm>!]	index==TRUE, wback==TRUE
STC{2}{L}<c><q> <coproc>, <CRd>, [<Rn>], #+/-<imm>	index==FALSE, wback==TRUE
STC{2}{L}<c><q> <coproc>, <CRd>, [<Rn>], <option>	index==FALSE, wback==TRUE, add==TRUE

where:

2 If specified, selects the C == 1 form of the encoding. If omitted, selects the C == 0 form.

L If specified, selects the N == 1 form of the encoding. If omitted, selects the N == 0 form.

<c><q> See *Standard assembler syntax fields* on page A5-6.

<coproc> Specifies the name of the coprocessor. The standard generic coprocessor names are p0, p1, ..., p15.

- <CRd> Specifies the coprocessor source register.
- <Rn> Specifies the base register. This register is allowed to be the SP.
- +/- Is + or omitted to indicate that the immediate offset is added to the base register value (`add == TRUE`), or - to indicate that the offset is to be subtracted (`add == FALSE`). Different instructions are generated for #0 and #-0.
- <imm> Specifies the immediate offset added to or subtracted from the value of <Rn> to form the address. Allowed values are multiples of 4 in the range 0-1020. For the offset addressing syntax, <imm> can be omitted, meaning an offset of 0.
- <option> Specifies additional instruction options to the coprocessor, as an integer in the range 0-255, surrounded by { and }. This integer is encoded in the imm8 field of the instruction.

The pre-UAL syntax `STC<c>L` is equivalent to `STCL<c>`.

Operation

```

if ConditionPassed() then
    EncodingSpecificOperations();
    if !Coprocc_Accepted(cp, ThisInstr()) then
        RaiseCoproccorException();
    else
        offset_addr = if add then (R[n] + imm32) else (R[n] - imm32);
        address = if index then offset_addr else R[n];
        if wback then R[n] = offset_addr;
        repeat
            value = Coproc_GetWordToStore(cp, ThisInstr());
            MemA[address,4] = value;
            address = address + 4;
        until Coproc_DoneStoring(cp, ThisInstr());

```

Exceptions

UsageFault, MemManage, BusFault.

A5.7.115 STMDB / STMFD

Store Multiple Decrement Before (Store Multiple Full Descending) stores multiple registers to sequential memory locations using an address from a base register. The sequential memory locations end just below this address, and the address of the first of those locations can optionally be written back to the base register.

Encoding

T1 STMDB<c> <Rn>{!}, <registers>

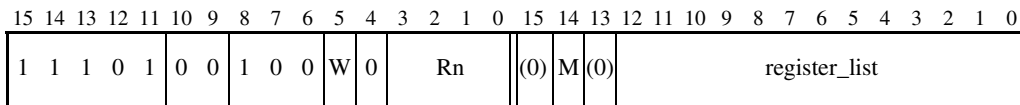

```
n = UInt(Rn); registers = '0':M:'0':register_list; wback = (W == '1');
if n == 13 && wback then SEE PUSH on page A5-208;
if n == 15 || BitCount(registers) < 2 then UNPREDICTABLE;
```

Architecture versions

Encoding T1 All versions of the Thumb instruction set from Thumb-2 onwards.

Assembler syntax

STMDB<c><q> <Rn>{!}, <registers>

where:

<c><q> See *Standard assembler syntax fields* on page A5-6.

<Rn> Specifies the base register. This register is allowed to be the SP. If it is the SP and ! is specified, it is treated as described in *PUSH* on page A5-208.

! Sets the W bit to 1, causing the instruction to write a modified value back to <Rn>. If ! is omitted, the instruction does not change <Rn>.

<registers>

Is a list of one or more registers, separated by commas and surrounded by { and }. It specifies the set of registers to be stored. The registers are stored with the lowest-numbered register to the lowest memory address, through to the highest-numbered register to the highest memory address.

Encoding T1 does not support a list containing only one register. If an STMDB instruction with just one register <Rt> in the list is assembled to Thumb, it is assembled to the equivalent STR<c><q> <Rt>, [<Rn>, #-4] {!} instruction.

The SP and PC cannot be in the list.

STMFD is a synonym for STMDB, referring to its use for pushing data onto Full Descending stacks.

The pre-UAL syntaxes STM<c>DB and STM<c>FD are equivalent to STMDB<c>.

Operation

```

if ConditionPassed() then
    EncodingSpecificOperations();
    originalRn = R[n];
    address = R[n] - 4*BitCount(registers);
    if wback then R[n] = R[n] + 4*BitCount(registers);
    for i = 0 to 14
        if registers<i> == '1' then
            if i == n && wback then
                if i == LowestSetBit(registers) then
                    MemA[address,4] = originalRn;
                else
                    MemA[address,4] = bits(32) UNKNOWN;
            else
                MemA[address,4] = R[i];
                address = address + 4;
    assert address == originalRn;

```

Exceptions

UsageFault, MemManage, BusFault.

A5.7.116 STMIA / STMEA

Store Multiple Increment After (Store Multiple Empty Ascending) stores multiple registers to consecutive memory locations using an address from a base register. The sequential memory locations start at this address, and the address just above the last of those locations can optionally be written back to the base register.

Encoding

T1 STMIA<c> <Rn>!,<registers>

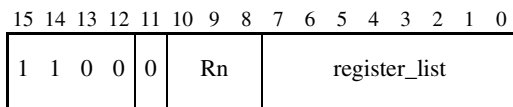

```
n = UInt(Rn); registers = '00000000':register_list; wback = TRUE;
if BitCount(registers) < 1 then UNPREDICTABLE;
```

T2 STMIA<c>.W <Rn>{!},<registers>

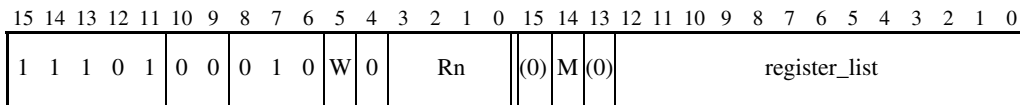

```
n = UInt(Rn); registers = '0':M:'0':register_list; wback = (W == '1');
if n == 15 || BitCount(registers) < 2 then UNPREDICTABLE;
```

Architecture versions

Encoding T1 All versions of the Thumb instruction set.

Encoding T2 All versions of the Thumb instruction set from Thumb-2 onwards.

Assembler syntax

STMIA<c><q> <Rn>{!}, <registers>

where:

<c><q> See *Standard assembler syntax fields* on page A5-6.

<Rn> Specifies the base register. This register is allowed to be the SP.

! Causes the instruction to write a modified value back to <Rn>. If ! is omitted, the instruction does not change <Rn>.

<registers>

Is a list of one or more registers, separated by commas and surrounded by { and }. It specifies the set of registers to be stored. The registers are stored with the lowest-numbered register to the lowest memory address, through to the highest-numbered register to the highest memory address.

Encoding T2 does not support a list containing only one register. If an STMIA instruction with just one register <Rt> in the list is assembled to Thumb and encoding T1 is not available, it is assembled to the equivalent STR<c><q> <Rt>, [<Rn>] {, #-4} instruction.

The SP and PC cannot be in the list.

STMEA is a synonym for STMIA, referring to its use for pushing data onto Empty Ascending stacks.

The pre-UAL syntaxes STM<c>IA and STM<c>EA are equivalent to STMIA<c>.

Operation

```

if ConditionPassed() then
    EncodingSpecificOperations();
    originalRn = R[n];
    address = R[n];
    if wback then R[n] = R[n] + 4*BitCount(registers);
    for i = 0 to 14
        if registers<i> == '1' then
            if i == n && wback then
                if i == LowestSetBit(registers) then
                    MemA[address,4] = originalRn;
                else
                    MemA[address,4] = bits(32) UNKNOWN;
            else
                MemA[address,4] = R[i];
                address = address + 4;
    assert address == originalRn + 4*BitCount(registers);

```

Exceptions

UsageFault, MemManage, BusFault.

A5.7.117 STR (immediate)

Store Register (immediate) calculates an address from a base register value and an immediate offset, and stores a word from a register to memory. It can use offset, post-indexed, or pre-indexed addressing. See *Memory accesses* on page A5-13 for information about memory accesses.

Encoding

T1 STR<c> <Rt>, [<Rn>, #<imm>]

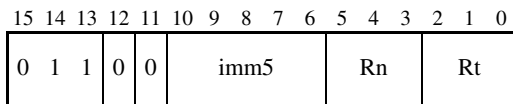

```
t = UInt(Rt); n = UInt(Rn); imm32 = ZeroExtend(imm5:'00', 32);
index = TRUE; add = TRUE; wback = FALSE;
```

T2 STR<c> <Rt>, [SP, #<imm>]

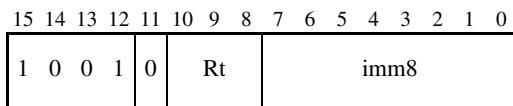

```
t = UInt(Rt); n = 13; imm32 = ZeroExtend(imm8:'00', 32);
index = TRUE; add = TRUE; wback = FALSE;
```

T3 STR<c>.W <Rt>, [<Rn>, #<imm12>]

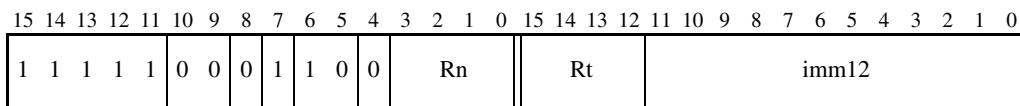

```
t = UInt(Rt); n = UInt(Rn); imm32 = ZeroExtend(imm12, 32);
index = TRUE; add = TRUE; wback = FALSE;
if n == 15 then UNDEFINED;
if t == 15 then UNPREDICTABLE;
```

T4 STR<c> <Rt>, [<Rn>, #-<imm8>]
 STR<c> <Rt>, [<Rn>], #+/-<imm8>
 STR<c> <Rt>, [<Rn>, #+/-<imm8>]!

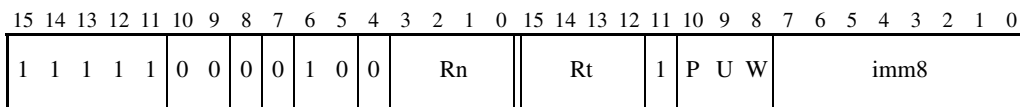

```
t = UInt(Rt); n = UInt(Rn); imm32 = ZeroExtend(imm8, 32);
index = (P == '1'); add = (U == '1'); wback = (W == '1');
if P == '1' && U == '1' && W == '0' then SEE STRT on page A5-274;
if n == 15 || (P == '0' && W == '0') then UNDEFINED;
if t == 15 || (wback && n == t) then UNPREDICTABLE;
```

Architecture versions

Encodings T1, T2 All versions of the Thumb instruction set.

Encodings T3, T4 All versions of the Thumb instruction set from Thumb-2 onwards.

Assembler syntax

```
STR<c><q> <Rt>, [<Rn> {, #+/-<imm>}] Offset: index==TRUE, wback==FALSE
STR<c><q> <Rt>, [<Rn>, #+/-<imm>! Pre-indexed: index==TRUE, wback==TRUE
STR<c><q> <Rt>, [<Rn>], #+/-<imm> Post-indexed: index==FALSE, wback==TRUE
```

where:

<c><q> See *Standard assembler syntax fields* on page A5-6.

<Rt> Specifies the source register. This register is allowed to be the SP.

<Rn> Specifies the base register. This register is allowed to be the SP.

+/- Is + or omitted to indicate that the immediate offset is added to the base register value (add == TRUE), or - to indicate that the offset is to be subtracted (add == FALSE). Different instructions are generated for #0 and #-0.

<imm> Specifies the immediate offset added to or subtracted from the value of <Rn> to form the address. Allowed values are multiples of 4 in the range 0-124 for encoding T1, multiples of 4 in the range 0-1020 for encoding T2, any value in the range 0-4095 for encoding T3, and any value in the range 0-255 for encoding T4. For the offset addressing syntax, <imm> can be omitted, meaning an offset of 0.

Operation

```
if ConditionPassed() then
    EncodingSpecificOperations();
    offset_addr = if add then (R[n] + imm32) else (R[n] - imm32);
    address = if index then offset_addr else R[n];
    if wback then R[n] = offset_addr;
    MemU[address,4] = R[t];
```

Exceptions

UsageFault, MemManage, BusFault.

A5.7.118 STR (register)

Store Register (register) calculates an address from a base register value and an offset register value, stores a word from a register to memory. The offset register value can be shifted left by 0, 1, 2, or 3 bits. See *Memory accesses* on page A5-13 for information about memory accesses.

Encoding

T1 STR<c> <Rt>, [<Rn>, <Rm>]

15	14	13	12	11	10	9	8	7	6	5	4	3	2	1	0
0	1	0	1	0	0	0	Rm	Rn	Rt						

```
t = UInt(Rt); n = UInt(Rn); m = UInt(Rm);
(shift_t, shift_n) = (SRTType_None, 0);
```

T2 STR<c>.W <Rt>, [<Rn>, <Rm>{, LSL #<shift>}]

15	14	13	12	11	10	9	8	7	6	5	4	3	2	1	0	15	14	13	12	11	10	9	8	7	6	5	4	3	2	1	0
1	1	1	1	1	0	0	0	0	1	0	0	Rn	Rt	0	0	0	0	0	0	0	shift	Rm									

```
t = UInt(Rt); n = UInt(Rn); m = UInt(Rm);
(shift_t, shift_n) = (SRTType_LSL, UInt(shift));
if n == 15 then UNDEFINED;
if t == 15 || BadReg(m) then UNPREDICTABLE;
```

Architecture versions

Encoding T1 All versions of the Thumb instruction set.

Encoding T2 All versions of the Thumb instruction set from Thumb-2 onwards.

Assembler syntax

```
STR<c><q> <Rt>, [<Rn>, <Rm> {, LSL #<shift>}]
```

where:

- <c><q> See *Standard assembler syntax fields* on page A5-6.
- <Rt> Specifies the source register. This register is allowed to be the SP.
- <Rn> Specifies the register that contains the base value. This register is allowed to be the SP.
- <Rm> Contains the offset that is shifted left and added to the value of <Rn> to form the address.
- <shift> Specifies the number of bits the value from <Rm> is shifted left, in the range 0-3. If this option is omitted, a shift by 0 is assumed and both encodings are permitted. If this option is specified, only encoding T2 is permitted.

Operation

```
if ConditionPassed() then
    EncodingSpecificOperations();
    address = R[n] + LSL(R[m], shift_n);
    MemU[address,4] = R[t];
```

Exceptions

UsageFault, MemManage, BusFault.

A5.7.119 STRB (immediate)

Store Register Byte (immediate) calculates an address from a base register value and an immediate offset, and stores a byte from a register to memory. It can use offset, post-indexed, or pre-indexed addressing. See *Memory accesses* on page A5-13 for information about memory accesses.

Encoding

T1 STRB<c> <Rt>, [<Rn>, #<imm>]

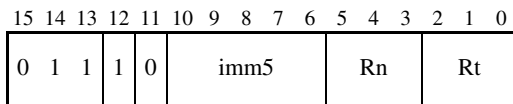

```
t = UInt(Rt); n = UInt(Rn); imm32 = ZeroExtend(imm5, 32);
index = TRUE; add = TRUE; wback = FALSE;
```

T2 STRB<c>.W <Rt>, [<Rn>, #<imm12>]

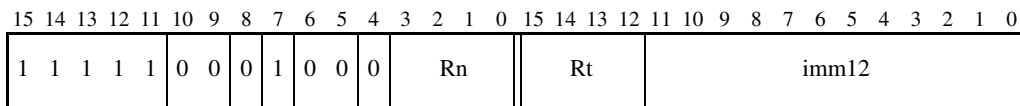

```
t = UInt(Rt); n = UInt(Rn); imm32 = ZeroExtend(imm12, 32);
index = TRUE; add = TRUE; wback = FALSE;
if n == 15 then UNDEFINED;
if BadReg(t) then UNPREDICTABLE;
```

T3 STRB<c> <Rt>, [<Rn>, #-<imm8>]
 STRB<c> <Rt>, [<Rn>], #+/-<imm8>
 STRB<c> <Rt>, [<Rn>, #+/-<imm8>!]

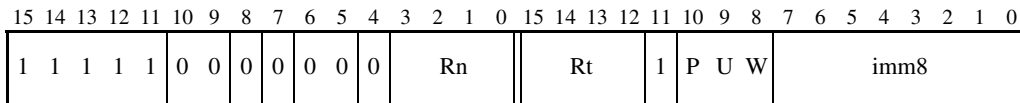

```
t = UInt(Rt); n = UInt(Rn); imm32 = ZeroExtend(imm8, 32);
index = (P == '1'); add = (U == '1'); wback = (W == '1');
if P == '1' && U == '1' && W == '0' then SEE STRBT on page A5-258;
if n == 15 || (P == '0' && W == '0') then UNDEFINED;
if BadReg(t) || (wback && n == t) then UNPREDICTABLE;
```

Architecture versions

Encoding T1 All versions of the Thumb instruction set.

Encodings T2, T3 All versions of the Thumb instruction set from Thumb-2 onwards.

Assembler syntax

STRB<c><q> <Rt>, [<Rn> {, #+/-<imm>}]	Offset: index==TRUE, wback==FALSE
STRB<c><q> <Rt>, [<Rn>, #+/-<imm>]!	Pre-indexed: index==TRUE, wback==TRUE
STRB<c><q> <Rt>, [<Rn>], #+/-<imm>	Post-indexed: index==FALSE, wback==TRUE

where:

<c><q>	See <i>Standard assembler syntax fields</i> on page A5-6.
<Rt>	Specifies the source register.
<Rn>	Specifies the base register. This register is allowed to be the SP.
+/-	Is + or omitted to indicate that the immediate offset is added to the base register value (add == TRUE), or - to indicate that the offset is to be subtracted (add == FALSE). Different instructions are generated for #0 and #-0.
<imm>	Specifies the immediate offset added to or subtracted from the value of <Rn> to form the address. The range of allowed values is 0-31 for encoding T1, 0-4095 for encoding T2, and 0-255 for encoding T3. For the offset addressing syntax, <imm> can be omitted, meaning an offset of 0.

The pre-UAL syntax STR<c>B is equivalent to STRB<c>.

Operation

```

if ConditionPassed() then
    EncodingSpecificOperations();
    offset_addr = if add then (R[n] + imm32) else (R[n] - imm32);
    address = if index then offset_addr else R[n];
    if wback then R[n] = offset_addr;
    MemU[address,1] = R[t]<7:0>;

```

Exceptions

MemManage, BusFault.

A5.7.120 STRB (register)

Store Register Byte (register) calculates an address from a base register value and an offset register value, and stores a byte from a register to memory. The offset register value can be shifted left by 0, 1, 2, or 3 bits. See *Memory accesses* on page A5-13 for information about memory accesses.

Encoding

T1 STRB<c> <Rt>, [<Rn>, <Rm>]

15	14	13	12	11	10	9	8	7	6	5	4	3	2	1	0
0	1	0	1	0	1	0	Rm			Rn			Rt		

```
t = UInt(Rt); n = UInt(Rn); m = UInt(Rm);
(shift_t, shift_n) = (SRTType_None, 0);
```

T2 STRB<c>.W <Rt>, [<Rn>, <Rm>{, LSL #<shift>}]

15	14	13	12	11	10	9	8	7	6	5	4	3	2	1	0	15	14	13	12	11	10	9	8	7	6	5	4	3	2	1	0
1	1	1	1	1	0	0	0	0	0	0	0	Rn			Rt			0	0 0 0 0 0				shift	Rm							

```
t = UInt(Rt); n = UInt(Rn); m = UInt(Rm);
(shift_t, shift_n) = (SRTType_LSL, UInt(shift));
if n == 15 then UNDEFINED;
if BadReg(t) || BadReg(m) then UNPREDICTABLE;
```

Architecture versions

Encoding T1 All versions of the Thumb instruction set.

Encoding T2 All versions of the Thumb instruction set from Thumb-2 onwards.

Assembler syntax

```
STRB<c><q> <Rt>, [<Rn>, <Rm> {, LSL #<shift>}]
```

where:

<c><q> See *Standard assembler syntax fields* on page A5-6.

<Rn> Specifies the register that contains the base value. This register is allowed to be the SP.

<Rm> Contains the offset that is shifted left and added to the value of <Rn> to form the address.

<shift> Specifies the number of bits the value from <Rm> is shifted left, in the range 0-3. If this option is omitted, a shift by 0 is assumed and both encodings are permitted. If this option is specified, only encoding T2 is permitted.

The pre-UAL syntax STR<c>B is equivalent to STRB<c>.

Operation

```
if ConditionPassed() then
    EncodingSpecificOperations();
    address = R[n] + LSL(R[m], shift_n);
    MemU[address,1] = R[t]<7:0>;
```

Exceptions

MemManage, BusFault.

A5.7.121 STRBT

Store Register Byte Unprivileged calculates an address from a base register value and an immediate offset, and stores a byte from a register to memory. See *Memory accesses* on page A5-13 for information about memory accesses.

The memory access is restricted as if the processor were running unprivileged. (This makes no difference if the processor is actually running unprivileged.)

Encoding

T1 STRBT<c> <Rt>, [<Rn>, #<imm8>]

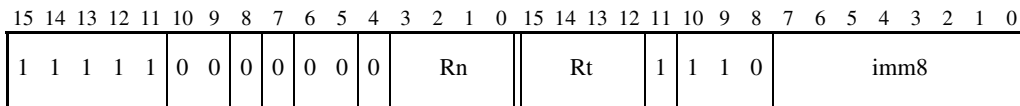

```
t = UInt(Rt); n = UInt(Rn); imm32 = ZeroExtend(imm8, 32);
if n == 15 then UNDEFINED;
if BadReg(t) then UNPREDICTABLE;
```

Architecture versions

Encoding T1 All versions of the Thumb instruction set from Thumb-2 onwards.

Assembler syntax

```
STRBT<c><q> <Rt>, [<Rn> {, #<imm>}]
```

where:

<c><q> See *Standard assembler syntax fields* on page A5-6.

<Rt> Specifies the source register.

<Rn> Specifies the base register. This register is allowed to be the SP.

<imm> Specifies the immediate offset added to the value of <Rn> to form the address. The range of allowed values is 0-255. <imm> can be omitted, meaning an offset of 0.

The pre-UAL syntax STR<c>BT is equivalent to STRBT<c>.

Operation

```
if ConditionPassed() then
    EncodingSpecificOperations();
    address = R[n] + imm32;
    MemU_unpriv[address,1] = R[t]<7:0>;
```

Exceptions

MemManage, BusFault.

A5.7.122 STRD (immediate)

Store Register Dual (immediate) calculates an address from a base register value and an immediate offset, and stores two words from two registers to memory. It can use offset, post-indexed, or pre-indexed addressing. See *Memory accesses* on page A5-13 for information about memory accesses.

Encoding

T1 STRD<c> <Rt>, <Rt2>, [<Rn>, #+/-<imm>]{!}
 STRD<c> <Rt>, <Rt2>, [<Rn>], #+/-<imm>

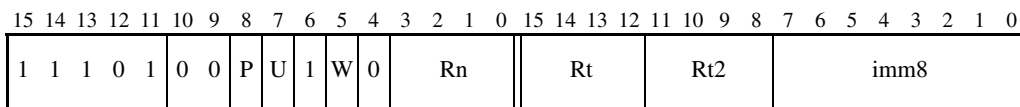

```
t = UInt(Rt);  t2 = UInt(Rt2);  n = UInt(Rn);
imm32 = ZeroExtend(imm8:'00', 32);
index = (P == '1');  add = (U == '1');  wback = (W == '1');
if P == '0' && W == '0' then
    SEE Load/store double and exclusive, and table branch on page A4-27;
if wback && t == n then UNPREDICTABLE;
if wback && t2 == n then UNPREDICTABLE;
if n == 15 || BadReg(t) || BadReg(t2) then UNPREDICTABLE;
```

Architecture versions

Encoding T1 All versions of the Thumb instruction set from Thumb-2 onwards.

Assembler syntax

STRD<c><q> <Rt>, <Rt2>, [<Rn>{, #+/-<imm>}] Offset: index==TRUE, wback==FALSE
 STRD<c><q> <Rt>, <Rt2>, [<Rn>, #+/-<imm>]! Pre-indexed: index==TRUE, wback==TRUE
 STRD<c><q> <Rt>, <Rt2>, [<Rn>], #+/-<imm> Post-indexed: index==FALSE, wback==TRUE

where:

<c><q> See *Standard assembler syntax fields* on page A5-6.
 <Rt> Specifies the first source register.
 <Rt2> Specifies the second source register.
 <Rn> Specifies the base register. This register is allowed to be the SP.
 +/- Is + or omitted to indicate that the immediate offset is added to the base register value (add == TRUE), or - to indicate that the offset is to be subtracted (add == FALSE). Different instructions are generated for #0 and #-0.
 <imm> Specifies the immediate offset added to or subtracted from the value of <Rn> to form the address. Allowed values are multiples of 4 in the range 0-1020. For the offset addressing syntax, <imm> can be omitted, meaning an offset of 0.

The pre-UAL syntax STR<c>D is equivalent to STRD<c>.

Operation

```
if ConditionPassed() then
    EncodingSpecificOperations();
    offset_addr = if add then (R[n] + imm32) else (R[n] - imm32);
    address = if index then offset_addr else R[n];
    if wback then R[n] = offset_addr;
    MemA[address,4] = R[t];
    MemA[address+4,4] = R[t2];
```

Exceptions

UsageFault, MemManage, BusFault.

A5.7.123 STREX

Store Register Exclusive calculates an address from a base register value and an immediate offset, and stores a word from a register to memory if the executing processor has exclusive access to the memory addressed.

See *Memory accesses* on page A5-13 for information about memory accesses.

Encoding

T1 STREX<c> <Rd>, <Rt>, [<Rn>{, #<imm>}]

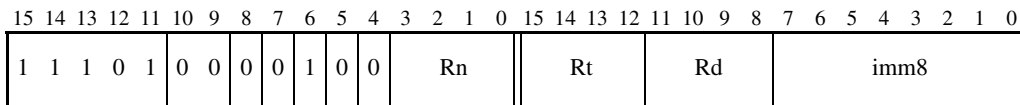

```
d = UInt(Rd); t = UInt(Rt); n = UInt(Rn);
imm32 = ZeroExtend(imm8:'00', 32);
if BadReg(d) || BadReg(t) || n == 15 then UNPREDICTABLE;
if d == n || d == t then UNPREDICTABLE;
```

Architecture versions

Encoding T1 All versions of the Thumb instruction set from Thumb-2 onwards.

Assembler syntax

```
STREX<c><q> <Rd>, <Rt>, [<Rn> {, #<imm>}]
```

where:

- <c><q> See *Standard assembler syntax fields* on page A5-6.
- <Rd> Specifies the destination register for the returned status value. The value returned is:
 - 0 if the operation updates memory
 - 1 if the operation fails to update memory.
- <Rt> Specifies the source register.
- <Rn> Specifies the base register. This register is allowed to be the SP.
- <imm> Specifies the immediate offset added to the value of <Rn> to form the address. Allowed values are multiples of 4 in the range 0-1020. <imm> can be omitted, meaning an offset of 0.

Operation

```
if ConditionPassed() then
    EncodingSpecificOperations();
    address = R[n] + imm32;
    if ExclusiveMonitorsPass(address,4) then
        MemAA[address,4] = R[t];
        R[d] = 0;
    else
        R[d] = 1;
```

Exceptions

UsageFault, MemManage, BusFault.

A5.7.124 STREXB

Store Register Exclusive Byte derives an address from a base register value, and stores a byte from a register to memory if the executing processor has exclusive access to the memory addressed.

See *Memory accesses* on page A5-13 for information about memory accesses.

Encoding

T1 STREXB<c> <Rd>, <Rt>, [<Rn>]

15	14	13	12	11	10	9	8	7	6	5	4	3	2	1	0	15	14	13	12	11	10	9	8	7	6	5	4	3	2	1	0
1	1	1	0	1	0	0	0	1	1	0	0	Rn			Rt			(1)	(1)	(1)	(1)	0	1	0	0	Rd					

```
d = UInt(Rd); t = UInt(Rt); n = UInt(Rn);
if BadReg(d) || BadReg(t) || n == 15 then UNPREDICTABLE;
if d == n || d == t then UNPREDICTABLE;
```

Architecture versions

Encoding T1 All versions of the Thumb instruction set from v6K onwards.

Assembler syntax

```
STREXB<c><q> <Rd>, <Rt>, [<Rn>]
```

where:

- <c><q> See *Standard assembler syntax fields* on page A5-6.
- <Rd> Specifies the destination register for the returned status value. The value returned is:
 - 0 if the operation updates memory
 - 1 if the operation fails to update memory.
- <Rt> Specifies the source register.
- <Rn> Specifies the base register. This register is allowed to be the SP.

Operation

```
if ConditionPassed() then
    EncodingSpecificOperations();
    address = R[n];
    if ExclusiveMonitorsPass(address,1) then
        MemAA[address,1] = R[t];
        R[d] = 0;
    else
        R[d] = 1;
```

Exceptions

MemManage, BusFault.

A5.7.125 STREXH

Store Register Exclusive Halfword derives an address from a base register value, and stores a halfword from a register to memory if the executing processor has exclusive access to the memory addressed.

See *Memory accesses* on page A5-13 for information about memory accesses.

Encoding

T1 STREXH<c> <Rd>, <Rt>, [<Rn>]

15	14	13	12	11	10	9	8	7	6	5	4	3	2	1	0	15	14	13	12	11	10	9	8	7	6	5	4	3	2	1	0
1	1	1	0	1	0	0	0	1	1	0	0	Rn			Rt			(1)	(1)	(1)	(1)	0	1	0	1	Rd					

```
d = UInt(Rd); t = UInt(Rt); n = UInt(Rn);
if BadReg(d) || BadReg(t) || n == 15 then UNPREDICTABLE;
if d == n || d == t then UNPREDICTABLE;
```

Architecture versions

Encoding T1 All versions of the Thumb instruction set from v6K onwards.

Assembler syntax

```
STREXH<c><q> <Rd>, <Rt>, [<Rn>]
```

where:

- <c><q> See *Standard assembler syntax fields* on page A5-6.
- <Rd> Specifies the destination register for the returned status value. The value returned is:
 - 0 if the operation updates memory
 - 1 if the operation fails to update memory.
- <Rt> Specifies the source register.
- <Rn> Specifies the base register. This register is allowed to be the SP.

Operation

```
if ConditionPassed() then
    EncodingSpecificOperations();
    address = R[n];
    if ExclusiveMonitorsPass(address,2) then
        MemAA[address,2] = R[t];
        R[d] = 0;
    else
        R[d] = 1;
```

Exceptions

UsageFault, MemManage, BusFault.

A5.7.126 STRH (immediate)

Store Register Halfword (immediate) calculates an address from a base register value and an immediate offset, and stores a halfword from a register to memory. It can use offset, post-indexed, or pre-indexed addressing. See *Memory accesses* on page A5-13 for information about memory accesses.

Encoding

T1 STRH<c> <Rt>, [<Rn>, #<imm>]

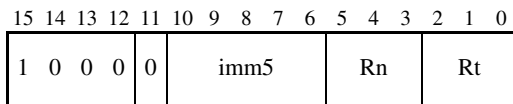

```
t = UInt(Rt); n = UInt(Rn); imm32 = ZeroExtend(imm5:'0', 32);
index = TRUE; add = TRUE; wback = FALSE;
```

T2 STRH<c>.W <Rt>, [<Rn>, #<imm12>]

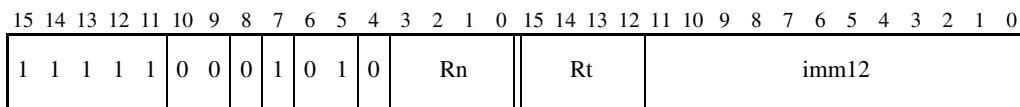

```
t = UInt(Rt); n = UInt(Rn); imm32 = ZeroExtend(imm12, 32);
index = TRUE; add = TRUE; wback = FALSE;
if n == 15 then UNDEFINED;
if BadReg(t) then UNPREDICTABLE;
```

T3 STRH<c> <Rt>, [<Rn>, #-<imm8>]
 STRH<c> <Rt>, [<Rn>], #+/-<imm8>
 STRH<c> <Rt>, [<Rn>, #+/-<imm8>!]

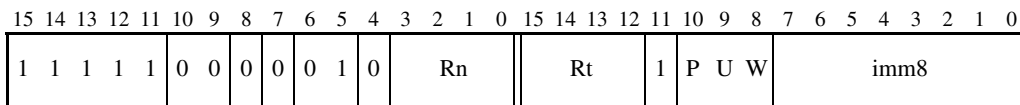

```
t = UInt(Rt); n = UInt(Rn); imm32 = ZeroExtend(imm8, 32);
index = (P == '1'); add = (U == '1'); wback = (W == '1');
if P == '1' && U == '1' && W == '0' then SEE STRHT on page A5-272;
if n == 15 || (P == '0' && W == '0') then UNDEFINED;
if BadReg(t) || (wback && n == t) then UNPREDICTABLE;
```

Architecture versions

Encoding T1 All versions of the Thumb instruction set.

Encodings T2, T3 All versions of the Thumb instruction set from Thumb-2 onwards.

Assembler syntax

`STRH<c><q> <Rt>, [<Rn> {, #+/-<imm>}]` Offset: `index==TRUE, wback==FALSE`
`STRH<c><q> <Rt>, [<Rn>, #+/-<imm>]!` Pre-indexed: `index==TRUE, wback==TRUE`
`STRH<c><q> <Rt>, [<Rn>], #+/-<imm>` Post-indexed: `index==FALSE, wback==TRUE`

where:

`<c><q>` See *Standard assembler syntax fields* on page A5-6.
`<Rt>` Specifies the source register.
`<Rn>` Specifies the base register. This register is allowed to be the SP.
`+/-` Is + or omitted to indicate that the immediate offset is added to the base register value (`add == TRUE`), or - to indicate that the offset is to be subtracted (`add == FALSE`). Different instructions are generated for #0 and #-0.
`<imm>` Specifies the immediate offset added to or subtracted from the value of `<Rn>` to form the address. Allowed values are multiples of 2 in the range 0-62 for encoding T1, any value in the range 0-4095 for encoding T2, and any value in the range 0-255 for encoding T3. For the offset addressing syntax, `<imm>` can be omitted, meaning an offset of 0.

The pre-UAL syntax `STR<c>H` is equivalent to `STRH<c>`.

Operation

```

if ConditionPassed() then
    EncodingSpecificOperations();
    offset_addr = if add then (R[n] + imm32) else (R[n] - imm32);
    address = if index then offset_addr else R[n];
    if wback then R[n] = offset_addr;
    MemU[address,2] = R[t]<15:0>;
  
```

Exceptions

UsageFault, MemManage, BusFault.

A5.7.127 STRH (register)

Store Register Halfword (register) calculates an address from a base register value and an offset register value, and stores a halfword from a register to memory. The offset register value can be shifted left by 0, 1, 2, or 3 bits. See *Memory accesses* on page A5-13 for information about memory accesses.

Encoding

T1 STRH<c> <Rt>, [<Rn>, <Rm>]

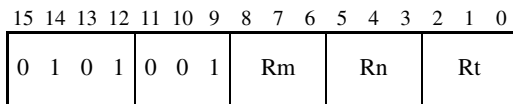

```
t = UInt(Rt); n = UInt(Rn); m = UInt(Rm);
(shift_t, shift_n) = (SRTType_None, 0);
```

T2 STRH<c>.W <Rt>, [<Rn>, <Rm>{, LSL #<shift>}]

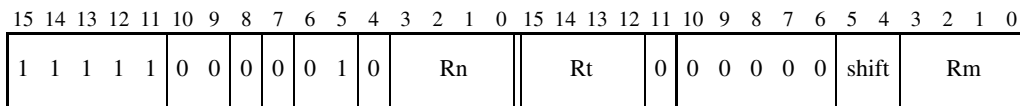

```
t = UInt(Rt); n = UInt(Rn); m = UInt(Rm);
(shift_t, shift_n) = (SRTType_LSL, UInt(shift));
if n == 15 then UNDEFINED;
if BadReg(t) || BadReg(m) then UNPREDICTABLE;
```

Architecture versions

Encoding T1 All versions of the Thumb instruction set.

Encoding T2 All versions of the Thumb instruction set from Thumb-2 onwards.

Assembler syntax

```
STRH<c><q> <Rt>, [<Rn>, <Rm> {, LSL #<shift>}]
```

where:

<c><q> See *Standard assembler syntax fields* on page A5-6.

<Rn> Specifies the register that contains the base value. This register is allowed to be the SP.

<Rm> Contains the offset that is shifted left and added to the value of <Rn> to form the address.

<shift> Specifies the number of bits the value from <Rm> is shifted left, in the range 0-3. If this option is omitted, a shift by 0 is assumed and both encodings are permitted. If this option is specified, only encoding T2 is permitted.

The pre-UAL syntax STR<c>H is equivalent to STRH<c>.

Operation

```
if ConditionPassed() then
    EncodingSpecificOperations();
    address = R[n] + LSL(R[m], shift_n);
    MemU[address,2] = R[t]<15:0>;
```

Exceptions

UsageFault, MemManage, BusFault.

A5.7.128 STRHT

Store Register Halfword Unprivileged calculates an address from a base register value and an immediate offset, and stores a halfword from a register to memory. See *Memory accesses* on page A5-13 for information about memory accesses.

The memory access is restricted as if the processor were running unprivileged. (This makes no difference if the processor is actually running unprivileged.)

Encoding

T1 STRHT<c> <Rt>, [<Rn>, #<imm8>]

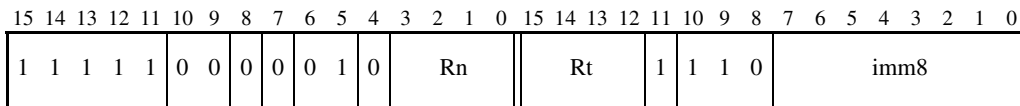

```
t = UInt(Rt); n = UInt(Rn); imm32 = ZeroExtend(imm8, 32);
if n == 15 then UNDEFINED;
if BadReg(t) then UNPREDICTABLE;
```

Architecture versions

Encoding T1 All versions of the Thumb instruction set from Thumb-2 onwards.

Assembler syntax

```
STRHT<c><q> <Rt>, [<Rn> {, #<imm>}]
```

where:

- <c><q> See *Standard assembler syntax fields* on page A5-6.
- <Rt> Specifies the source register.
- <Rn> Specifies the base register. This register is allowed to be the SP.
- <imm> Specifies the immediate offset added to the value of <Rn> to form the address. The range of allowed values is 0-255. <imm> can be omitted, meaning an offset of 0.

Operation

```
if ConditionPassed() then
    EncodingSpecificOperations();
    address = R[n] + offset;
    MemU_unpriv[address,2] = R[t]<15:0>;
```

Exceptions

UsageFault, MemManage, BusFault.

A5.7.129 STRT

Store Register Unprivileged calculates an address from a base register value and an immediate offset, and stores a word from a register to memory. See *Memory accesses* on page A5-13 for information about memory accesses.

The memory access is restricted as if the processor were running unprivileged. (This makes no difference if the processor is actually running unprivileged.)

Encoding

T1 STRT<c> <Rt>, [<Rn>, #<imm8>]

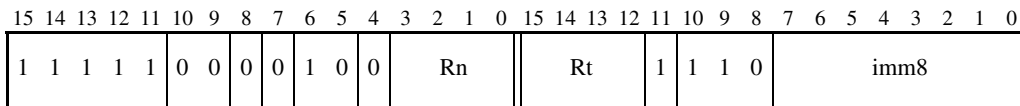

```
t = UInt(Rt); n = UInt(Rn); imm32 = ZeroExtend(imm8, 32);
if n == 15 then UNDEFINED;
if BadReg(t) then UNPREDICTABLE;
```

Architecture versions

Encoding T1 All versions of the Thumb instruction set from Thumb-2 onwards.

Assembler syntax

```
STRT<c><q> <Rt>, [<Rn> {, #<imm>}]
```

where:

- <c><q> See *Standard assembler syntax fields* on page A5-6.
- <Rt> Specifies the source register.
- <Rn> Specifies the base register. This register is allowed to be the SP.
- <imm> Specifies the immediate offset added to the value of <Rn> to form the address. The range of allowed values is 0-255. <imm> can be omitted, meaning an offset of 0.

The pre-UAL syntax STR<c>T is equivalent to STRT<c>.

Operation

```
if ConditionPassed() then
    EncodingSpecificOperations();
    address = R[n] + imm32;
    MemU_unpriv[address,4] = R[t];
```

Exceptions

UsageFault, MemManage, BusFault.

A5.7.130 SUB (immediate)

This instruction subtracts an immediate value from a register value, and writes the result to the destination register. It can optionally update the condition flags based on the result.

Encodings

T1 SUBS <Rd>, <Rn>, #<imm3> Outside IT block.
 SUB<c> <Rd>, <Rn>, #<imm3> Inside IT block.

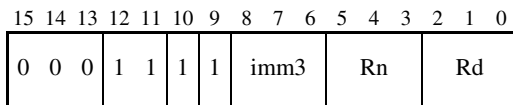

```
d = UInt(Rd); n = UInt(Rn); setflags = !InITBlock();
imm32 = ZeroExtend(imm3, 32);
```

T2 SUBS <Rdn>, #<imm8> Outside IT block.
 SUB<c> <Rdn>, #<imm8> Inside IT block.

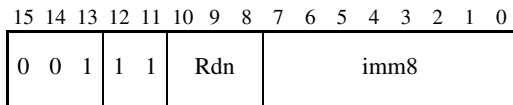

```
d = UInt(Rdn); n = UInt(Rdn); setflags = !InITBlock();
imm32 = ZeroExtend(imm8, 32);
```

T3 SUB{S}<c>.W <Rd>, <Rn>, #<const>

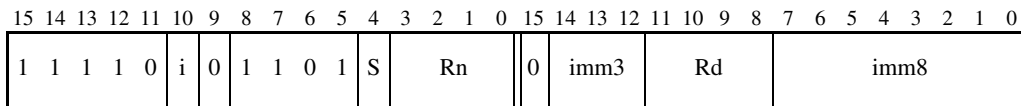

```
d = UInt(Rd); n = UInt(Rn); setflags = (S == '1');
imm32 = ThumbExpandImm(i:imm3:imm8);
if d == 15 && setflags then SEE CMP (immediate) on page A5-73;
if n == 13 then SEE SUB (SP minus immediate) on page A5-281;
if BadReg(d) || n == 15 then UNPREDICTABLE;
```

T4 SUBW<c> <Rd>, <Rn>, #<imm12>

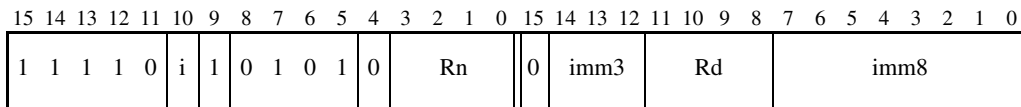

```

d = UInt(Rd); n = UInt(Rn); setflags = FALSE;
imm32 = ZeroExtend(i:imm3:imm8, 32);
if n == 15 then SEE ADR on page A5-30;
if n == 13 then SEE SUB (SP minus immediate) on page A5-281;
if BadReg(d) then UNPREDICTABLE;

```

Architecture versions

Encodings T1, T2 All versions of the Thumb instruction set.

Encodings T3, T4 All versions of the Thumb instruction set from Thumb-2 onwards.

Assembler syntax

```

SUB{S}<c><q> {<Rd>,> <Rn>, #<const>           All encodings permitted
SUBW<c><q> {<Rd>,> <Rn>, #<const>           Only encoding T4 permitted

```

where:

S If present, specifies that the instruction updates the flags. Otherwise, the instruction does not update the flags.

<c><q> See *Standard assembler syntax fields* on page A5-6.

<Rd> Specifies the destination register. If <Rd> is omitted, this register is the same as <Rn>.

<Rn> Specifies the register that contains the first operand. If the SP is specified for <Rn>, see *SUB (SP minus immediate)* on page A5-281. If the PC is specified for <Rn>, see *ADR* on page A5-30.

<const> Specifies the immediate value to be subtracted from the value obtained from <Rn>. The range of allowed values is 0-7 for encoding T1, 0-255 for encoding T2 and 0-4095 for encoding T4. See *Immediate constants* on page A5-8 for the range of allowed values for encoding T3.

When multiple encodings of the same length are available for an instruction, encoding T3 is preferred to encoding T4 (if encoding T4 is required, use the SUBW syntax). Encoding T1 is preferred to encoding T2 if <Rd> is specified and encoding T2 is preferred to encoding T1 if <Rd> is omitted.

The pre-UAL syntax SUB<c>S is equivalent to SUBS<c>.

Operation

```

if ConditionPassed() then
    EncodingSpecificOperations();
    (result, carry, overflow) = AddWithCarry(R[n], NOT(imm32), '1');
    R[d] = result;

```

Thumb Instructions

```
if setflags then
    APSR.N = result<31>; APSR.Z = IsZeroBit(result);
    APSR.C = carry;      APSR.V = overflow;
```

Exceptions

None.

A5.7.131 SUB (register)

This instruction subtracts an optionally-shifted register value from a register value, and writes the result to the destination register. It can optionally update the condition flags based on the result.

Encodings

T1 SUBS <Rd>, <Rn>, <Rm> Outside IT block.
 SUB<c> <Rd>, <Rn>, <Rm> Inside IT block.

15	14	13	12	11	10	9	8	7	6	5	4	3	2	1	0
0	0	0	1	1	0	1	Rm			Rn			Rd		

```
d = UInt(Rd); n = UInt(Rn); m = UInt(Rm); setflags = !InITBlock();
(shift_t, shift_n) = (SRTYPE_None, 0);
```

T2 SUB{S}<c>.W <Rd>, <Rn>, <Rm>{, <shift>}

15	14	13	12	11	10	9	8	7	6	5	4	3	2	1	0	15	14	13	12	11	10	9	8	7	6	5	4	3	2	1	0
1	1	1	0	1	0	1	1	0	1	S	Rn			(0)	imm3			Rd			imm2		type		Rm						

```
d = UInt(Rd); n = UInt(Rn); m = UInt(Rm); setflags = (S == '1');
(shift_t, shift_n) = DecodeImmShift(type, imm3:imm2);
if d == 15 && setflags then SEE CMP (register) on page A5-75;
if n == 13 then SEE SUB (SP minus register) on page A5-283;
if BadReg(d) || n == 15 || BadReg(m) then UNPREDICTABLE;
```

Architecture versions

Encoding T1 All versions of the Thumb instruction set.

Encoding T2 All versions of the Thumb instruction set from Thumb-2 onwards.

Assembler syntax

```
SUB{S}<c><q> {<Rd>, } <Rn>, <Rm> {,<shift>}
```

where:

S	If present, specifies that the instruction updates the flags. Otherwise, the instruction does not update the flags.
<c><q>	See <i>Standard assembler syntax fields</i> on page A5-6.
<Rd>	Specifies the destination register. If <Rd> is omitted, this register is the same as <Rn>.
<Rn>	Specifies the register that contains the first operand. If the SP is specified for <Rn>, see <i>SUB (SP minus register)</i> on page A5-283.
<Rm>	Specifies the register that is optionally shifted and used as the second operand.
<shift>	Specifies the shift to apply to the value read from <Rm>. If <shift> is omitted, no shift is applied and both encodings are permitted. If <shift> is specified, only encoding T2 is permitted. The possible shifts and how they are encoded are described in <i>Constant shifts applied to a register</i> on page A5-10.

The pre-UAL syntax SUB<c>S is equivalent to SUBS<c>.

Operation

```
if ConditionPassed() then
    EncodingSpecificOperations();
    shifted = Shift(R[m], shift_t, shift_n, APSR.C);
    (result, carry, overflow) = AddWithCarry(R[n], NOT(shifted), '1');
    R[d] = result;
    if setflags then
        APSR.N = result<31>;
        APSR.Z = IsZeroBit(result);
        APSR.C = carry;
        APSR.V = overflow;
```

Exceptions

None.

A5.7.132 SUB (SP minus immediate)

This instruction subtracts an immediate value from the SP value, and writes the result to the destination register.

Encodings

T1 SUB<c> SP,SP,#<imm>

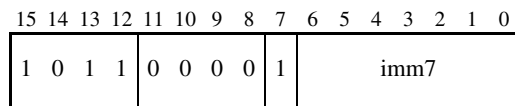

```
d = 13; setflags = FALSE; imm32 = ZeroExtend(imm7:'00', 32);
```

T2 SUB{S}<c>.W <Rd>,SP,#<const>

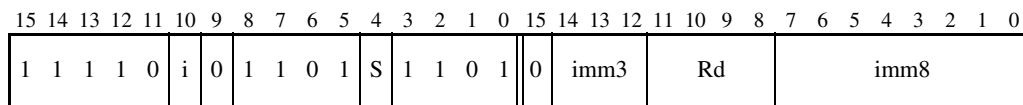

```
d = UInt(Rd); setflags = (S == '1');
imm32 = ThumbExpandImm(i:imm3:imm8);
if d == 15 && setflags then SEE CMP (immediate) on page A5-73;
if d == 15 then UNPREDICTABLE;
```

T3 SUBW<c> <Rd>,SP,#<imm12>

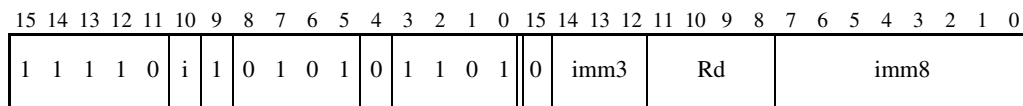

```
d = UInt(Rd); setflags = FALSE; imm32 = ZeroExtend(i:imm3:imm8, 32);
if d == 15 then UNPREDICTABLE;
```

Architecture versions

Encoding T1 All versions of the Thumb instruction set.

Encodings T2, T3 All versions of the Thumb instruction set from Thumb-2 onwards.

Assembler syntax

SUB{S}<c><q> {<Rd>, } SP, #<const> All encodings permitted
 SUBW<c><q> {<Rd>, } SP, #<const> Only encoding T4 permitted

where:

- S** If present, specifies that the instruction updates the flags. Otherwise, the instruction does not update the flags.
- <c><q>** See *Standard assembler syntax fields* on page A5-6.
- <Rd>** Specifies the destination register. If <Rd> is omitted, this register is SP.
- <const>** Specifies the immediate value to be added to the value obtained from <Rn>. Allowed values are multiples of 4 in the range 0-508 for encoding T1 and any value in the range 0-4095 for encoding T3. See *Immediate constants* on page A5-8 for the range of allowed values for encoding T2.
- When both 32-bit encodings are available for an instruction, encoding T2 is preferred to encoding T3 (if encoding T3 is required, use the SUBW syntax).

The pre-UAL syntax SUB<c>S is equivalent to SUBS<c>.

Operation

```
if ConditionPassed() then
    EncodingSpecificOperations();
    (result, carry, overflow) = AddWithCarry(SP, NOT(imm32), '1');
    R[d] = result;
    if setflags then
        APSR.N = result<31>;
        APSR.Z = IsZeroBit(result);
        APSR.C = carry;
        APSR.V = overflow;
```

Exceptions

None.

A5.7.133 SUB (SP minus register)

This instruction subtracts an optionally-shifted register value from the SP value, and writes the result to the destination register.

Encodings

T1 SUB<c> <Rd>,SP,<Rm>{,<shift>}

15	14	13	12	11	10	9	8	7	6	5	4	3	2	1	0	15	14	13	12	11	10	9	8	7	6	5	4	3	2	1	0
1	1	1	0	1	0	1	1	1	0	1	S	1	1	0	1	(0)	imm3	Rd	imm2	type	Rm										

```
d = UInt(Rd); m = UInt(Rm); setflags = (S == '1');
(shift_t, shift_n) = DecodeImmShift(type, imm3:imm2);
if d == 15 || BadReg(m) then UNPREDICTABLE;
```

Architecture versions

Encoding T1 All versions of the Thumb instruction set from Thumb-2 onwards.

Assembler syntax

```
SUB{S}<c><q> {<Rd>,<Rd>} SP, <Rm> {,<shift>}
```

where:

- S** If present, specifies that the instruction updates the flags. Otherwise, the instruction does not update the flags.
- <c><q>** See *Standard assembler syntax fields* on page A5-6.
- <Rd>** Specifies the destination register. If <Rd> is omitted, this register is SP.
- <Rm>** Specifies the register that is optionally shifted and used as the second operand.
- <shift>** Specifies the shift to apply to the value read from <Rm>. If <shift> is omitted, no shift is applied. The possible shifts and how they are encoded are described in *Constant shifts applied to a register* on page A5-10.

The pre-UAL syntax SUB<c>S is equivalent to SUBS<c>.

Operation

```
if ConditionPassed() then
    EncodingSpecificOperations();
    shifted = Shift(R[m], shift_t, shift_n, APSR.C);
    (result, carry, overflow) = AddWithCarry(SP, NOT(shifted), '1');
    R[d] = result;
    if setflags then
        APSR.N = result<31>;
        APSR.Z = IsZeroBit(result);
        APSR.C = carry;
        APSR.V = overflow;
```

Exceptions

None.

A5.7.134 SVC (formerly SWI)

Generates a supervisor call. See *Exceptions* in the *ARM Architecture Reference Manual*.

Use it as a call to an operating system to provide a service.

Encodings

T1 SVC<c> #<imm8>

15	14	13	12	11	10	9	8	7	6	5	4	3	2	1	0
1	1	0	1	1	1	1	1	imm8							

```
imm32 = ZeroExtend(imm24, 32);
// imm32 is for assembly/disassembly only and is ignored by hardware
```

Architecture versions

Encoding T1 All versions of the Thumb instruction set from Thumb-2 onwards.
Behavior modified for the M profile exception model.

Assembler syntax

```
SVC<c><q> #<imm>
```

where:

<c><q> See *Standard assembler syntax fields* on page A5-6.

<imm> Specifies an 8-bit immediate constant.

The pre-UAL syntax *SWI*<c> is equivalent to *SVC*<c>.

Operation

```
if ConditionPassed() then
    EncodingSpecificOperations();
    CallSupervisor();
```

Exceptions

SVCall.

A5.7.135 SXTB

Signed Extend Byte extracts an 8-bit value from a register, sign extends it to 32 bits, and writes the result to the destination register. You can specify a rotation by 0, 8, 16, or 24 bits before extracting the 8-bit value.

Encodings

T1 SXTB<c> <Rd>, <Rm>

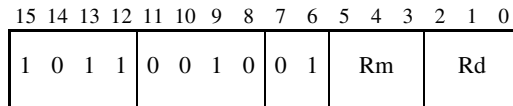

```
d = UInt(Rd); m = UInt(Rm); rotation = 0;
```

T2 SXTB<c>.W <Rd>, <Rm>{, <rotation>}

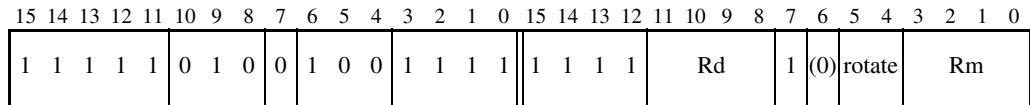

```
d = UInt(Rd); m = UInt(Rm); rotation = UInt(rotate:'000');
if BadReg(d) || BadReg(m) then UNPREDICTABLE;
```

Architecture versions

Encoding T1 All versions of the Thumb instruction set from ARMv6 onwards.

Encoding T2 All versions of the Thumb instruction set from Thumb-2 onwards.

Assembler syntax

```
SXTB<c><q> <Rd>, <Rm> {, <rotation>}
```

where:

<c><q> See *Standard assembler syntax fields* on page A5-6.

<Rd> Specifies the destination register.

<Rm> Specifies the register that contains the operand.

<rotation>

This can be any one of:

- ROR #8.
- ROR #16.
- ROR #24.
- Omitted.

Note

If your assembler accepts shifts by #0 and treats them as equivalent to no shift or LSL #0, then it must accept ROR #0 here. It is equivalent to omitting <rotation>.

Operation

```
if ConditionPassed() then
    EncodingSpecificOperations();
    rotated = ROR(R[m], rotation);
    R[d] = SignExtend(rotated<7:0>, 32);
```

Exceptions

None.

A5.7.136 SXTB

Signed Extend Halfword extracts a 16-bit value from a register, sign extends it to 32 bits, and writes the result to the destination register. You can specify a rotation by 0, 8, 16, or 24 bits before extracting the 16-bit value.

Encodings

T1 SXTB<c> <Rd>, <Rm>

15	14	13	12	11	10	9	8	7	6	5	4	3	2	1	0
1	0	1	1	0	0	1	0	0	0	Rm			Rd		

```
d = UInt(Rd); m = UInt(Rm); rotation = 0;
```

T2 SXTB<c>.W <Rd>, <Rm>{, <rotation>}

15	14	13	12	11	10	9	8	7	6	5	4	3	2	1	0	15	14	13	12	11	10	9	8	7	6	5	4	3	2	1	0
1	1	1	1	1	0	1	0	0	0	0	0	1	1	1	1	1	1	1	1	Rd			1	(0)	rotate	Rm					

```
d = UInt(Rd); m = UInt(Rm); rotation = UInt(rotate:'000');
if BadReg(d) || BadReg(m) then UNPREDICTABLE;
```

Architecture versions

Encoding T1 All versions of the Thumb instruction set from ARMv6 onwards.

Encoding T2 All versions of the Thumb instruction set from Thumb-2 onwards.

Assembler syntax

```
SXTH<c><q> <Rd>, <Rm> {, <rotation>}
```

where:

<c><q> See *Standard assembler syntax fields* on page A5-6.

<Rd> Specifies the destination register.

<Rm> Specifies the register that contains the operand.

<rotation>

This can be any one of:

- ROR #8.
- ROR #16.
- ROR #24.
- Omitted.

Note

If your assembler accepts shifts by #0 and treats them as equivalent to no shift or LSL #0, then it must accept ROR #0 here. It is equivalent to omitting <rotation>.

Operation

```
if ConditionPassed() then
    EncodingSpecificOperations();
    rotated = ROR(R[m], rotation);
    R[d] = SignExtend(rotated<15:0>, 32);
```

Exceptions

None.

A5.7.137 TBB

Table Branch Byte causes a PC-relative forward branch using a table of single byte offsets. A base register provides a pointer to the table, and a second register supplies an index into the table. The branch length is twice the value of the byte returned from the table.

Encodings

T1 TBB [<Rn>, <Rm>]

Outside or last in IT block

15	14	13	12	11	10	9	8	7	6	5	4	3	2	1	0	15	14	13	12	11	10	9	8	7	6	5	4	3	2	1	0
1	1	1	0	1	0	0	0	1	1	0	1	Rn				(1)	(1)	(1)	(1)	(0)	(0)	(0)	(0)	0	0	0	0	Rm			

```
n = UInt(Rn); m = UInt(Rm);
if n == 13 || BadReg(m) then UNPREDICTABLE;
if InITBlock() && !LastInITBlock() then UNPREDICTABLE;
```

Architecture versions

Encoding T1 All versions of the Thumb instruction set from Thumb-2 onwards.

Assembler syntax

TBB<q> [<Rn>, <Rm>]

where:

- <q> See *Standard assembler syntax fields* on page A5-6.
- <Rn> Specifies the base register. This contains the address of the table of branch lengths. This register is allowed to be the PC. If it is, the table immediately follows this instruction.
- <Rm> Specifies the index register. This contains an integer pointing to a single byte within the table. The offset within the table is the value of the index.

Operation

```
if ConditionPassed() then
    EncodingSpecificOperations();
    halfwords = MemU[R[n]+R[m], 1];
    BranchWritePC(PC + ZeroExtend(halfwords:'0', 32));
```

Exceptions

MemManage, BusFault.

A5.7.138 TBH

Table Branch Halfword causes a PC-relative forward branch using a table of single halfword offsets. A base register provides a pointer to the table, and a second register supplies an index into the table. The branch length is twice the value of the halfword returned from the table.

Encodings

T1 TBH [<Rn>, <Rm>, LSL #1] Outside or last in IT block

15	14	13	12	11	10	9	8	7	6	5	4	3	2	1	0	15	14	13	12	11	10	9	8	7	6	5	4	3	2	1	0
1	1	1	0	1	0	0	0	1	1	0	1	Rn				(1)	(1)	(1)	(1)	(0)	(0)	(0)	(0)	0	0	0	1	Rm			

```
n = UInt(Rn); m = UInt(Rm);
if n == 13 || BadReg(m) then UNPREDICTABLE;
if InITBlock() && !LastInITBlock() then UNPREDICTABLE;
```

Architecture versions

Encoding T1 All versions of the Thumb instruction set from Thumb-2 onwards.

Assembler syntax

TBH<q> [<Rn>, <Rm>, LSL #1]

where:

- <q> See *Standard assembler syntax fields* on page A5-6.
- <Rn> Specifies the base register. This contains the address of the table of branch lengths. This register is allowed to be the PC. If it is, the table immediately follows this instruction.
- <Rm> Specifies the index register. This contains an integer pointing to a halfword within the table. The offset within the table is twice the value of the index.

Operation

```
if ConditionPassed() then
    EncodingSpecificOperations();
    halfwords = MemU[R[n]+LSL(R[m],1), 2];
    BranchWritePC(PC + ZeroExtend(halfwords:'0', 32));
```

Exceptions

UsageFault, MemManage, BusFault.

A5.7.139 TEQ (immediate)

Test Equivalence (immediate) performs an exclusive OR operation on a register value and an immediate value. It updates the condition flags based on the result, and discards the result.

Encodings

T1 TEQ<c> <Rn>, #<const>

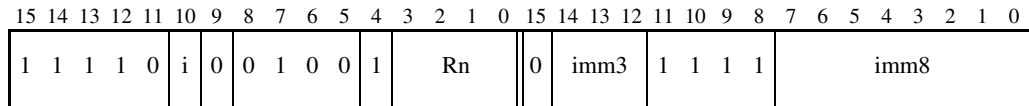

```
n = UInt(Rn);
(imm32, carry) = ThumbExpandImmWithC(i:imm3:imm8, APSR.C);
if BadReg(n) then UNPREDICTABLE;
```

Architecture versions

Encoding T1 All versions of the Thumb instruction set from Thumb-2 onwards.

Assembler syntax

```
TEQ<c><q> <Rn>, #<const>
```

where:

<c><q> See *Standard assembler syntax fields* on page A5-6.

<Rn> Specifies the register that contains the operand.

<const> Specifies the immediate value to be added to the value obtained from <Rn>. See *Immediate constants* on page A5-8 for the range of allowed values.

Operation

```
if ConditionPassed() then
    EncodingSpecificOperations();
    result = R[n] EOR imm32;
    APSR.N = result<31>;
    APSR.Z = IsZeroBit(result);
    APSR.C = carry;
    // APSR.V unchanged
```

Exceptions

None.

A5.7.140 TEQ (register)

Test Equivalence (register) performs an exclusive OR operation on a register value and an optionally-shifted register value. It updates the condition flags based on the result, and discards the result.

Encodings

T1 TEQ<c> <Rn>, <Rm> {,<shift>}

15	14	13	12	11	10	9	8	7	6	5	4	3	2	1	0	15	14	13	12	11	10	9	8	7	6	5	4	3	2	1	0
1	1	1	0	1	0	1	0	1	0	0	1	Rn	(0)	imm3	1	1	1	1	imm2	type	Rm										

```
n = UInt(Rn); m = UInt(Rm);
(shift_t, shift_n) = DecodeImmShift(type, imm3:imm2);
if BadReg(n) || BadReg(m) THEN UNPREDICTABLE;
```

Architecture versions

Encoding T1 All versions of the Thumb instruction set from Thumb-2 onwards.

Assembler syntax

TEQ<c><q> <Rn>, <Rm> {,<shift>}

where:

<c><q> See *Standard assembler syntax fields* on page A5-6.

<Rn> Specifies the register that contains the first operand.

<Rm> Specifies the register that is optionally shifted and used as the second operand.

<shift> Specifies the shift to apply to the value read from <Rm>. If <shift> is omitted, no shift is applied. The possible shifts and how they are encoded are described in *Constant shifts applied to a register* on page A5-10.

Operation

```
if ConditionPassed() then
    EncodingSpecificOperations();
    (shifted, carry) = Shift_C(R[m], shift_t, shift_n, APSR.C);
    result = R[n] EOR shifted;
    APSR.N = result<31>;
    APSR.Z = IsZeroBit(result);
    APSR.C = carry;
    // APSR.V unchanged
```

Exceptions

None.

A5.7.141 TST (immediate)

Test (immediate) performs a logical AND operation on a register value and an immediate value. It updates the condition flags based on the result, and discards the result.

Encodings

T1 TST<c> <Rn>, #<const>

15	14	13	12	11	10	9	8	7	6	5	4	3	2	1	0	15	14	13	12	11	10	9	8	7	6	5	4	3	2	1	0
1	1	1	1	0	i	0	0	0	0	0	1	Rn				0	imm3			1	1	1	1	imm8							

```
n = UInt(Rn);
(imm32, carry) = ThumbExpandImmWithC(i:imm3:imm8, APSR.C);
if BadReg(n) then UNPREDICTABLE;
```

Architecture versions

Encoding T1 All versions of the Thumb instruction set from Thumb-2 onwards.

Assembler syntax

TST<c><q> <Rn>, #<const>

where:

<c><q> See *Standard assembler syntax fields* on page A5-6.

<Rn> Specifies the register that contains the operand.

<const> Specifies the immediate value to be added to the value obtained from <Rn>. See *Immediate constants* on page A5-8 for the range of allowed values.

Operation

```
if ConditionPassed() then
    EncodingSpecificOperations();
    result = R[n] AND imm32;
    APSR.N = result<31>;
    APSR.Z = IsZeroBit(result);
    APSR.C = carry;
    // APSR.V unchanged
```

Exceptions

None.

A5.7.142 TST (register)

Test (register) performs a logical AND operation on a register value and an optionally-shifted register value. It updates the condition flags based on the result, and discards the result.

Encodings

T1 TST<c> <Rn>, <Rm>

15	14	13	12	11	10	9	8	7	6	5	4	3	2	1	0
0	1	0	0	0	0	0	1	0	0	0	0	Rm	Rn		

```
n = UInt(Rdn); m = UInt(Rm);
(shift_t, shift_n) = (SRTYPE_None, 0);
```

T2 TST<c>.W <Rn>, <Rm>{, <shift>}

15	14	13	12	11	10	9	8	7	6	5	4	3	2	1	0	15	14	13	12	11	10	9	8	7	6	5	4	3	2	1	0
1	1	1	0	1	0	1	0	0	0	0	1	Rn	(0)	imm3	1	1	1	1	imm2	type	Rm										

```
n = UInt(Rn); m = UInt(Rm);
(shift_t, shift_n) = DecodeImmShift(type, imm3:imm2);
if BadReg(n) || BadReg(m) THEN UNPREDICTABLE;
```

Architecture versions

Encoding T1 All versions of the Thumb instruction set.

Encoding T2 All versions of the Thumb instruction set from Thumb-2 onwards.

Assembler syntax

```
TST<c><q> <Rn>, <Rm> {,<shift>}
```

where:

- <c><q> See *Standard assembler syntax fields* on page A5-6.
- <Rn> Specifies the register that contains the first operand.
- <Rm> Specifies the register that is optionally shifted and used as the second operand.
- <shift> Specifies the shift to apply to the value read from <Rm>. If <shift> is omitted, no shift is applied and both encodings are permitted. If <shift> is specified, only encoding T2 is permitted. The possible shifts and how they are encoded are described in *Constant shifts applied to a register* on page A5-10.

Operation

```
if ConditionPassed() then
    EncodingSpecificOperations();
    (shifted, carry) = Shift_C(R[m], shift_t, shift_n, APSR.C);
    result = R[n] AND shifted;
    APSR.N = result<31>;
    APSR.Z = IsZeroBit(result);
    APSR.C = carry;
    // APSR.V unchanged
```

Exceptions

None.

A5.7.143 UBFX

Unsigned Bit Field Extract extracts any number of adjacent bits at any position from one register, zero extends them to 32 bits, and writes the result to the destination register.

Encodings

T1 UBFX<c> <Rd>, <Rn>, #<lsb>, #<width>

15	14	13	12	11	10	9	8	7	6	5	4	3	2	1	0	15	14	13	12	11	10	9	8	7	6	5	4	3	2	1	0
1	1	1	1	0	(0)	1	1	1	1	0	0	Rn				0	imm3			Rd			imm2		(0)	widthm1					

```
d = UInt(Rd); n = UInt(Rn);
lsbit = UInt(imm3:imm2); widthminus1 = UInt(widthm1);
if BadReg(d) || BadReg(n) then UNPREDICTABLE;
```

Architecture versions

Encoding T1 All versions of the Thumb instruction set from Thumb-2 onwards.

Assembler syntax

UBFX<c><q> <Rd>, <Rn>, #<lsb>, #<width>

where:

- <c><q> See *Standard assembler syntax fields* on page A5-6.
- <Rd> Specifies the destination register.
- <Rn> Specifies the register that contains the first operand.
- <lsb> is the bit number of the least significant bit in the bitfield, in the range 0-31. This determines the required value of `lsbit`.
- <width> is the width of the bitfield, in the range 1 to 32-<lsb>). The required value of `widthminus1` is `<width>-1`.

Operation

```
if ConditionPassed() then
    EncodingSpecificOperations();
    msbit = lsbit + widthminus1;
    if msbit <= 31 then
        R[d] = ZeroExtend(R[n]<msbit:lsbit>, 32);
    else
        UNPREDICTABLE;
```

Exceptions

None.

A5.7.144 UDIV

Unsigned Divide divides a 32-bit unsigned integer register value by a 32-bit unsigned integer register value, and writes the result to the destination register. The condition code flags are not affected.

Encodings

T1 UDIV<c> <Rd>, <Rn>, <Rm>

15	14	13	12	11	10	9	8	7	6	5	4	3	2	1	0	15	14	13	12	11	10	9	8	7	6	5	4	3	2	1	0
1	1	1	1	1	0	1	1	1	0	1	1	Rn			(1)	(1)	(1)	(1)	Rd			1	1	1	1	Rm					

```
d = UInt(Rd); n = UInt(Rn); m = UInt(Rm);
if BadReg(d) || BadReg(n) || BadReg(m) then UNPREDICTABLE;
```

Architecture versions

Encoding T1 Specific profiles of ARMv7 onwards, including ARMv7-M.

Assembler syntax

UDIV<c><q> {<Rd> , } <Rn> , <Rm>

where:

<c><q> See *Standard assembler syntax fields* on page A5-6.

<Rd> Specifies the destination register. If <Rd> is omitted, this register is the same as <Rn>.

<Rn> Specifies the register that contains the dividend.

<Rm> Specifies the register that contains the divisor.

Operation

```
if ConditionPassed() then
    EncodingSpecificOperations();
    if UInt(R[m]) == 0 then
        if IntegerZeroDivideTrappingEnabled() then
            RaiseIntegerZeroDivide();
        else
            result = 0;
    else
        result = RoundTowardsZero(UInt(R[n]) / UInt(R[m]));
    R[d] = result<31:0>;
```

Exceptions

UsageFault.

A5.7.145 UMLAL

Unsigned Multiply Accumulate Long multiplies two unsigned 32-bit values to produce a 64-bit value, and accumulates this with a 64-bit value.

Encodings

T1 UMLAL<c> <RdLo>, <RdHi>, <Rn>, <Rm>

15	14	13	12	11	10	9	8	7	6	5	4	3	2	1	0	15	14	13	12	11	10	9	8	7	6	5	4	3	2	1	0
1	1	1	1	1	0	1	1	1	1	1	0	Rn				RdLo				RdHi				0 0 0 0				Rm			

```
dLo = UInt(RdLo); dHi = UInt(RdHi); n = UInt(Rn); m = UInt(Rm);
if BadReg(dLo) || BadReg(dHi) || BadReg(n) || BadReg(m) then UNPREDICTABLE;
if dHi == dLo then UNPREDICTABLE;
```

Architecture versions

Encoding T1 All versions of the Thumb instruction set from Thumb-2 onwards.

Assembler syntax

UMLAL<c><q> <RdLo>, <RdHi>, <Rn>, <Rm>

where:

- <c><q> See *Standard assembler syntax fields* on page A5-6.
- <RdLo> Supplies the lower 32 bits of the accumulate value, and is the destination register for the lower 32 bits of the result.
- <RdHi> Supplies the upper 32 bits of the accumulate value, and is the destination register for the upper 32 bits of the result.
- <Rn> Specifies the register that contains the first operand.
- <Rm> Specifies the register that contains the second operand.

Operation

```
if ConditionPassed() then
    EncodingSpecificOperations();
    result = UInt(R[n]) * UInt(R[m]) + UInt(R[dHi]:R[dLo]);
    R[dHi] = result<63:32>;
    R[dLo] = result<31:0>;
```

Exceptions

None.

A5.7.146 UMULL

Unsigned Multiply Long multiplies two 32-bit unsigned values to produce a 64-bit result.

Encodings

T1 UMULL<c> <RdLo>, <RdHi>, <Rn>, <Rm>

15	14	13	12	11	10	9	8	7	6	5	4	3	2	1	0	15	14	13	12	11	10	9	8	7	6	5	4	3	2	1	0
1	1	1	1	1	0	1	1	1	0	1	0	Rn			RdLo			RdHi			0	0	0	0	Rm						

```
dLo = UInt(RdLo); dHi = UInt(RdHi); n = UInt(Rn); m = UInt(Rm);
if BadReg(dLo) || BadReg(dHi) || BadReg(n) || BadReg(m) then UNPREDICTABLE;
if dHi == dLo then UNPREDICTABLE;
```

Architecture versions

Encoding T1 All versions of the Thumb instruction set from Thumb-2 onwards.

Assembler syntax

UMULL<c><q> <RdLo>, <RdHi>, <Rn>, <Rm>

where:

- <c><q> See *Standard assembler syntax fields* on page A5-6.
- <RdLo> Stores the lower 32 bits of the result.
- <RdHi> Stores the upper 32 bits of the result.
- <Rn> Specifies the register that contains the first operand.
- <Rm> Specifies the register that contains the second operand.

Operation

```
if ConditionPassed() then
    EncodingSpecificOperations();
    result = UInt(R[n]) * UInt(R[m]);
    R[dHi] = result<63:32>;
    R[dLo] = result<31:0>;
```

Exceptions

None.

A5.7.147 USAT

Unsigned Saturate saturates an optionally-shifted signed value to a selected unsigned range.

The Q flag is set if the operation saturates.

Encodings

T1 USAT<c> <Rd>, #<imm>, <Rn>{, <shift>}

15	14	13	12	11	10	9	8	7	6	5	4	3	2	1	0	15	14	13	12	11	10	9	8	7	6	5	4	3	2	1	0
1	1	1	1	0	(0)	1	1	1	0	sh	0	Rn				0	imm3			Rd			imm2	(0)	sat_imm						

```
d = UInt(Rd); n = UInt(Rn); saturate_to = UInt(sat_imm);
if sh == 1 && imm3:imm2 == '00000' then UNDEFINED;
(shift_t, shift_n) = DecodeImmShift(sh:'0', imm3:imm2);
if BadReg(d) || BadReg(n) then UNPREDICTABLE;
```

Architecture versions

Encoding T1 All versions of the Thumb instruction set from Thumb-2 onwards.

Assembler syntax

USAT<c><q> <Rd>, #<imm>, <Rn> {,<shift>}

where:

- <c><q> See *Standard assembler syntax fields* on page A5-6.
- <Rd> Specifies the destination register.
- <imm> Specifies the bit position for saturation, in the range 0 to 31.
- <Rn> Specifies the register that contains the value to be saturated.
- <shift> Specifies the optional shift. If present, it must be one of:

LSL #N

N must be in the range 0 to 31.

ASR #N

N must be in the range 1 to 31.

If <shift> is omitted, LSL #0 is used.

Operation

```
if ConditionPassed() then
    EncodingSpecificOperations();
    operand = Shift(R[n], shift_t, shift_n, APSR.C); // APSR.C ignored
    (result, sat) = UnsignedSatQ(SInt(operand), saturate_to);
    R[d] = ZeroExtend(result, 32);
    if sat then
        APSR.Q = '1';
```

Exceptions

None.

A5.7.148 UXTB

Unsigned Extend Byte extracts an 8-bit value from a register, zero extends it to 32 bits, and writes the result to the destination register. You can specify a rotation by 0, 8, 16, or 24 bits before extracting the 8-bit value.

Encodings

T1 UXTB<c> <Rd>, <Rm>

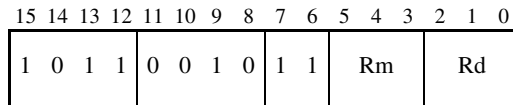

```
d = UInt(Rd); m = UInt(Rm); rotation = 0;
```

T2 UXTB<c>.W <Rd>, <Rm>{, <rotation>}

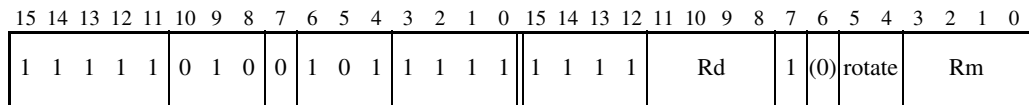

```
d = UInt(Rd); m = UInt(Rm); rotation = UInt(rotate:'000');
if BadReg(d) || BadReg(m) then UNPREDICTABLE;
```

Architecture versions

Encoding T1 All versions of the Thumb instruction set from ARMv6 onwards.

Encoding T2 All versions of the Thumb instruction set from Thumb-2 onwards.

Assembler syntax

UXTB<c><q> <Rd>, <Rm> {, <rotation>}

where:

<c><q> See *Standard assembler syntax fields* on page A5-6.

<Rd> Specifies the destination register.

<Rm> Specifies the register that contains the second operand.

<rotation>

This can be any one of:

- ROR #8.
- ROR #16.
- ROR #24.
- Omitted.

Note

If your assembler accepts shifts by #0 and treats them as equivalent to no shift or LSL #0, then it must accept ROR #0 here. It is equivalent to omitting <rotation>.

Operation

```
if ConditionPassed() then
    EncodingSpecificOperations();
    rotated = ROR(R[m], rotation);
    R[d] = ZeroExtend(rotated<7:0>, 32);
```

Exceptions

None.

A5.7.149 UXTH

Unsigned Extend Halfword extracts a 16-bit value from a register, zero extends it to 32 bits, and writes the result to the destination register. You can specify a rotation by 0, 8, 16, or 24 bits before extracting the 16-bit value.

Encodings

T1 UXTH<c> <Rd>, <Rm>

15	14	13	12	11	10	9	8	7	6	5	4	3	2	1	0
1	0	1	1	0	0	1	0	1	0	Rm				Rd	

```
d = UInt(Rd); m = UInt(Rm); rotation = 0;
```

T2 UXTH<c>.W <Rd>, <Rm>{, <rotation>}

15	14	13	12	11	10	9	8	7	6	5	4	3	2	1	0	15	14	13	12	11	10	9	8	7	6	5	4	3	2	1	0
1	1	1	1	1	0	1	0	0	0	0	1	1	1	1	1	1	1	1	1	Rd				1	(0)	rotate	Rm				

```
d = UInt(Rd); m = UInt(Rm); rotation = UInt(rotate:'000');
if BadReg(d) || BadReg(m) then UNPREDICTABLE;
```

Architecture versions

Encoding T1 All versions of the Thumb instruction set from ARMv6 onwards.

Encoding T2 All versions of the Thumb instruction set from Thumb-2 onwards.

Assembler syntax

UXTH<c><q> <Rd>, <Rm> {, <rotation>}

where:

<c><q> See *Standard assembler syntax fields* on page A5-6.

<Rd> Specifies the destination register.

<Rm> Specifies the register that contains the second operand.

<rotation>

This can be any one of:

- ROR #8.
- ROR #16.
- ROR #24.
- Omitted.

Note

If your assembler accepts shifts by #0 and treats them as equivalent to no shift or LSL #0, then it must accept ROR #0 here. It is equivalent to omitting <rotation>.

Operation

```
if ConditionPassed() then
    EncodingSpecificOperations();
    rotated = ROR(R[m], rotation);
    R[d] = ZeroExtend(rotated<15:0>, 32);
```

Exceptions

None.

A5.7.150 WFE

Wait For Event is a hint instruction. If the Event Register is clear, it suspends execution in the lowest power state available consistent with a fast wakeup without the need for software restoration, until a reset, exception or other event occurs. See *WaitForEvent()* on page AppxA-29 for more details.

For general hint behavior, see *NOP-compatible hints* on page A5-15.

Encodings**T1** WFE<c>

15	14	13	12	11	10	9	8	7	6	5	4	3	2	1	0
1	0	1	1	1	1	1	1	0	0	1	0	0	0	0	0

// Do nothing

T2 WFE<c>.W

15	14	13	12	11	10	9	8	7	6	5	4	3	2	1	0	15	14	13	12	11	10	9	8	7	6	5	4	3	2	1	0
1	1	1	1	1	0	0	1	1	1	0	1	0	(1)	(1)	(1)	(1)	1	0	(0)	0	(0)	0	0	0	0	0	0	0	0	1	0

// Do nothing

Architecture versions**Encodings T1, T2** All versions of the Thumb instruction set from v6K onwards.

Assembler syntax

WFE<c><q>

where:

<c><q> See *Standard assembler syntax fields* on page A5-6.

Operation

```
if ConditionPassed() then
    EncodingSpecificOperations();
    if EventRegistered() then
        ClearEventRegister();
    else
        WaitForEvent();
```

Exceptions

None.

A5.7.151 WFI

Wait For Interrupt is a hint instruction. It suspends execution, in the lowest power state available consistent with a fast wakeup without the need for software restoration, until a reset, asynchronous exception or other event occurs. See *WaitForInterrupt()* on page AppxA-29 for more details.

For general hint behavior, see *NOP-compatible hints* on page A5-15.

Encodings

T1 WFI<c>

15	14	13	12	11	10	9	8	7	6	5	4	3	2	1	0
1	0	1	1	1	1	1	1	0	0	1	1	0	0	0	0

// Do nothing

T2 WFI<c>.W

15	14	13	12	11	10	9	8	7	6	5	4	3	2	1	0	15	14	13	12	11	10	9	8	7	6	5	4	3	2	1	0
1	1	1	1	1	0	0	1	1	1	0	1	0	(1)	(1)	(1)	(1)	1	0	(0)	0	(0)	0	0	0	0	0	0	0	0	1	1

// Do nothing

Architecture versions

Encodings T1, T2 All versions of the Thumb instruction set from v6K onwards.

Assembler syntax

WFI<c><q>

where:

<c><q> See *Standard assembler syntax fields* on page A5-6.

Operation

```
if ConditionPassed() then
    EncodingSpecificOperations();
    WaitForInterrupt();
```

Exceptions

None.

Notes

PRIMASK If PRIMASK is set and FAULTMASK is clear, an asynchronous exception that has a higher group priority than any active exception and a higher group priority than BASEPRI results in a WFI instruction exit. If the group priority of the exception is less than or equal to the execution group priority, the exception is ignored.

A5.7.152 YIELD

`YIELD` is a hint instruction. It allows software with a multithreading capability to indicate to the hardware that it is performing a task, for example a spinlock, that could be swapped out to improve overall system performance. Hardware can use this hint to suspend and resume multiple code threads if it supports the capability.

For general hint behavior, see *NOP-compatible hints* on page A5-15.

Encodings

T1 `YIELD<c>`

15	14	13	12	11	10	9	8	7	6	5	4	3	2	1	0
1	0	1	1	1	1	1	1	0	0	0	1	0	0	0	0

// Do nothing

T2 `YIELD<c>.W`

15	14	13	12	11	10	9	8	7	6	5	4	3	2	1	0	15	14	13	12	11	10	9	8	7	6	5	4	3	2	1	0
1	1	1	1	0	0	1	1	1	0	1	0	(1)	(1)	(1)	(1)	1	0	(0)	0	(0)	0	0	0	0	0	0	0	0	1		

// Do nothing

Architecture versions

Encodings T1, T2 All versions of the Thumb instruction set from v6K onwards.

Assembler syntax

YIELD<c><q>

where:

<c><q> See *Standard assembler syntax fields* on page A5-6.

Operation

```
if ConditionPassed() then
    EncodingSpecificOperations();
    Hint_Yield();
```

Exceptions

None.

Part B

System

Chapter B1

System Level Programmer's Model

This chapter provides a summary of the ARMv7-M system programmer's model. It is designed to be read in conjunction with a device Technical Reference Manual (TRM). The TRM provides specific details for the device including the register interfaces and their programming models. The chapter is made up of the following sections:

- *Introduction to the system level* on page B1-2
- *System programmer's model* on page B1-3

B1.1 Introduction to the system level

The ARM architecture is defined in a hierarchical manner, where the features are described in Chapter A2 *Application Level Programmer's Model* at the application level, with underlying system support. What features are available and how they are supported is defined in the architecture profiles, making the system level support profile specific. Deprecated features can be found in an appendix to this manual. See page AppxD-1.

As stated in *Privileged execution* on page A2-3, programs can execute in a privileged or unprivileged manner. System level support requires privileged access, allowing it the access permissions to configure and control the resources. This is typically supported by an operating system, which provides system services to the applications, either transparently, or through application initiated service calls. The operating system is also responsible for servicing interrupts and other system events, making exceptions a key component of the system level programmer's model.

In addition, ARMv7-M is a departure from the normal architecture evolution in that it has been designed to take the ARM architecture to lower cost/performance points than previously supported as well as having a strong migration path to ARMv7-R and the broad spectrum of embedded processing.

———— **Note** —————

In deeply embedded systems, particularly at low cost/performance points, the distinction between the operating system and application is sometimes blurred, resulting in the software developed as a homogeneous codebase.

B1.2 System programmer's model

ARMv7-M is a memory-mapped architecture, meaning physical addresses as well as processor registers are architecturally assigned to provide event entry points (vectors), system control and configuration. Exception handler entry points are maintained in a table of address pointers.

The address space 0xE0000000 to 0xFFFFFFFF is RESERVED for system level use. The first 1MB of the system address space (0xE0000000 to 0xE00FFFFF) is reserved by ARM and known as the Private Peripheral Bus (PPB), with the rest of the address space (from 0xE0100000) IMPLEMENTATION DEFINED with some memory attribute restrictions. See *The system address map* on page B2-2 for more details.

Within the PPB address space, a 4kB block in the range 0xE000E000 to 0xE000EFFF is assigned for system control and known as the System Control Space (SCS). The SCS supports:

- CPU ID registers
- General control and configuration (including the vector table base address)
- System handler support (for system interrupts and exceptions)
- A SysTick system timer
- A Nested Vectored Interrupt Controller (NVIC), supporting up to 496 discrete external interrupts. All exceptions and interrupts share a common prioritization model
- Fault status and control registers
- The Protected Memory System Architecture (PMSAv7)
- Processor debug

See *System Control Space (SCS)* on page B2-7 for more details.

B1.2.1 System level operation and terminology overview

Several concepts are critical to the understanding of the system level architecture support.

Modes, Privilege and Stacks

Mode, privilege and stack pointer are key concepts used in ARMv7-M.

Mode The microcontroller profile supports two modes (Thread and Handler modes). Handler mode is entered as a result of an exception. An exception return can only be issued in Handler mode.

Thread mode is entered on Reset, and can be entered as a result of an exception return.

Privilege Code can execute as privileged or unprivileged. Unprivileged execution limits or excludes access to some resources. Privileged execution has access to all resources. Handler mode is always privileged. Thread mode can be privileged or unprivileged.

Stack Pointer Two separate banked stack pointers exist, the Main Stack Pointer, and the Process Stack pointer. The Main Stack Pointer can be used in either Thread or Handler mode. The Process Stack Pointer can only be used in Thread mode. See *The SP registers* on page B1-7 for more details.

———— **Note** —————

Resource space has been reserved but not defined in the ARMv7-M architecture for supporting a third level stack in a future version of this architecture profile. A third stack provides an alternative stack (from Main) for Handler mode. Table B1-19-1 shows the relationship between mode, privilege and stack pointer usage:

Table B1-1 Mode, Privilege and stack relationship

Mode	Privilege	Stack Pointer	Example (typical) usage model
Handler	Privileged	Main	Exception handling
Handler	Unprivileged	Any	Reserved combination (Handler is always privileged)
Handler	Any	Process	Reserved combination (Handler always uses the Main stack)
Thread	Privileged	Main	Execution of a privileged process/thread using a common stack in a system that only supports privileged access
Thread	Privileged	Process	Execution of a privileged process/thread using a stack reserved for that process/thread in a system that only supports privileged access, or where a mix of privileged and unprivileged threads exist.
Thread	Unprivileged	Main	Execution of an unprivileged process/thread using a common stack in a system that supports privileged and unprivileged (User) access
Thread	Unprivileged	Process	Execution of an unprivileged process/thread using a stack reserved for that process/thread in a system that supports privileged and unprivileged (User) access

Exceptions

An exception is a condition that changes the normal flow of control in a program. Exception behavior splits into two parts:

- Exception recognition when an exception event is generated and presented to the processor

- Exception processing (activation) when the processor is executing an exception entry, exception return, or exception handler code sequence. Migration from exception recognition to processing can be instantaneous.

Exceptions can be split into four categories

Reset Reset is a special form of exception which terminates current execution in a potentially unrecoverable way when reset is asserted. When reset is de-asserted execution is restarted from a fixed point.

Supervisor call A supervisor call is an exception which is explicitly caused by an instruction (SVC) designed to generate an exception.

Fault A fault is an exception which results from an error condition due to instruction execution. Faults can be reported synchronously or asynchronously to the instruction which caused them. In general, faults are reported synchronously. The Imprecise BusFault is an asynchronous fault supported in the ARMv7-M profile.

A synchronous fault is always reported with the instruction which caused the fault. An asynchronous fault does not guarantee how it is reported with respect to the instruction which caused the fault.

Debug monitor exceptions are classified as faults.

Interrupt An interrupt is an exception, other than a reset, fault or a supervisor call. All interrupts are asynchronous to the instruction stream. Typically interrupts are used by other elements within the system which wish to communicate with the processor, including software running on other processors.

Each exception has:

- A priority level
- An exception number
- A vector in memory which defines the entry-point (address) for execution on taking the exception. The associated code is described as the exception handler or the interrupt service routine (ISR).

Each exception, other than reset, is in one of three possible states:

- An Inactive exception is one which is not Pending or Active.
- A Pending exception is one where the exception event has been generated, and which has not yet started being processed on the processor.
- An Active exception is one whose handler has been started on a processor, but processing is not complete. An Active exception can be either running or pre-empted by a higher priority exception.

Asynchronous exceptions can be both Pending and Active at the same time, where one instance of the exception is Active, and a second instance of the exception is Pending.

Priority Levels and Execution Pre-emption

All exceptions are assigned a priority level, the exception priority. Three exceptions have fixed values, while all others can be altered by privileged software. In addition, the instruction stream executing on the processor has a priority level associated with it, the execution priority. An exception whose exception priority is sufficiently¹ higher than the execution priority will become active. In this case, the currently running instruction stream is pre-empted, and the exception that is taken is activated.

When an instruction stream is pre-empted by an exception other than reset, key context information is saved onto the stack automatically. Execution branches to the code pointed to by the exception vector that has been activated.

Exception Return

When in handler state, an exception handler can return. If the exception is both Active and Pending (a second instance of the exception has occurred while it is being serviced), it is re-entered or becomes Pending according to the prioritization rules. If the exception is Active only, it becomes Inactive. The key information that was stacked is restored, and execution returns to the code pre-empted by the exception. The target of the exception return is determined by the Exception Return Link, a value stored in the link register on exception entry.

Execution State

ARMv7-M only executes Thumb instructions, both 16-bit and 32-bit instructions and always executes in Thumb state. Thumb state is indicated by an execution status bit (EPSR.T == 1) within the architecture, see *The special-purpose processor status registers (xPSR)* on page B1-7. Setting EPSR.T to zero in ARMv7-M causes a fault when the next instruction executes.

Debug State

Debug state is entered when a core is configured to halt on a debug event, and a debug event occurs. See Chapter C1 *Debug* for more details.

The alternative debug mechanism (generate a DebugMonitor exception) does not use debug state.

B1.2.2 Registers

The ARMv7-M profile has the following registers closely coupled to the core.

- General Purpose registers R0-R12
- 2 Stack Pointer registers, SP_main and SP_process (banked versions of R13)
- The Link Register, LR (R14)
- The Program Counter, PC
- Status registers for flags, exception/interrupt level, and execution state bits
- Mask registers associated with managing the prioritization scheme for exceptions and interrupts
- A control register (CONTROL) to identify the current stack and privilege level

1. The concept of sufficiently higher relates to priority grouping within the exception prioritisation model.

All other registers described in this specification are memory mapped.

The SP registers

There are two stacks supported in ARMv7-M, each with its own (banked) stack pointer register.

- The Main stack – SP_main
- The Process stack – SP_process

ARMv7-M implementations treat bits[1:0] as RAZ/WI. Software should treat bits[1:0] as SBZP for maximum portability across ARMv7 profiles.

The special-purpose processor status registers (xPSR)

Processor status at the system level breaks down into three categories. They can be accessed as individual registers, a combination of any two from three, or a combination of all three using the MRS and MSR instructions.

- The Application Processor Status Register APSR - User writeable flags.
- The Interrupt Processor Status Register IPSR – Exception Number (for current execution)
- The Execution Processor Status Register EPSR - Execution state bits
- The APSR, IPSR and EPSR registers are allocated as mutually exclusive bitfields within a 32-bit register. The combination of the APSR, IPSR and EPSR registers is referred to as the xPSR register, for example in the pseudocode.

Table B1-2 The xPSR register layout

	31	30	29	28	27	26	25	24	23	16	15	10	9	8	0	
APSR	N	Z	C	V	Q											
IPSR												0 or Exception Number				
EPSR						ICI/IT		T					ICI/IT			

The APSR is modified by flag setting instructions and used to evaluate conditional execution in IT and conditional branch instructions. The flags (NZCVQ) are as described in *Registers* on page B1-6. The flags are UNPREDICTABLE on reset.

The IPSR is written on exception entry and exit. It can be read using an MRS instruction. Writes to the IPSR by an MSR instruction are ignored. The IPSR Exception Number field is cleared on reset and defined as follows:

- When in Thread mode, the value is 0.

- When in Handler mode, the value reflects the exception number as defined in *Exception Number Definition* on page B1-11.

The EPSR contains the T-bit and overlaid IT/ICI execution state bits to support the `IT` instruction or interrupt-continue load/store instructions. All fields read as zero using an `MRS` instruction. `MSR` writes are ignored.

The EPSR T-bit supports the ARM architecture interworking model, however, as ARMv7-M only supports execution of Thumb instructions, it must always be maintained with the value T-bit == 1. Updates to the PC which comply with the Thumb instruction interworking rules must update the T-bit accordingly. The execution of an instruction with the EPSR T-bit clear will cause an invalid state (INVSTATE) UsageFault. The T-bit is set and the IT/ICI bits cleared on reset (see *Reset Behavior* on page B1-12 for details).

The ICI/IT bits are used for saved IT state or saved exception-continuable instruction state.

- The IT bits provide context information for the conditional execution of a sequence of instructions such that it can be interrupted and restarted at the appropriate point. See the `IT` instruction definition in Chapter A5 *Thumb Instructions* for more information.
- The ICI bits provide information on the outstanding register list for exception-continuable multi-cycle load and store instructions.

The IT feature takes precedence over the ICI feature if an exception-continuable instruction is used within an IT construct. In this situation, the multi-cycle load or store instruction is treated as restartable.

All unused bits in the individual or combined registers are reserved.

The special-purpose mask registers

There are three special-purpose registers associated with exception priority management.

- The exception mask register `PRIMASK` which has a 1 bit value
- The base priority mask `BASEPRI` which has an 8 bit value
- The fault escalation mask `FAULTMASK` which has a 1 bit value.

All registers are cleared on reset. All unprivileged writes are ignored.

The format of the registers is illustrated in Table B1-3.

Table B1-3 The Special-Purpose Mask RegistersW

	31	8 7	1 0
PRIMASK	RESERVED		PM
FAULTMASK	RESERVED		FM
BASEPRI	RESERVED		BASEPRI

These registers can be accessed using the MSR/MRS instructions. The CPS instruction can be used to modify PRIMASK and FAULTMASK.

For more details see the appropriate ARM core or device documentation.

The special-purpose control register

The special-purpose CONTROL register is a 2-bit register defined as follows:

- Bit[0] defines the Thread mode privilege (Handler mode is always privileged)
- Bit[1] defines the Thread mode stack (Handler mode always uses SP_main)
- Bits[31:2] reserved

The CONTROL register is cleared on reset. The MRS instruction is used to read the register, and the MSR instruction is used to write the register. An ISB barrier instruction is required to ensure a register write access takes effect before the next instruction is executed. Unprivileged write accesses are ignored.

For more details see the appropriate ARM core or device documentation.

B1.2.3 Exception model

The exception model is central to the architecture and system correctness in the ARMv7-M profile. The ARMv7-M profile uses hardware saving and restoring of key context state on exception entry and exit, and a table of vectors to determine the exception entry points.

Overview of the Exceptions Supported

The following exceptions are supported by the ARMv7-M profile.

Reset Two levels of reset are supported by the ARMv7-M profile, covering different levels of reset of the system state. The different levels of reset control which registers are forced to their reset values on the de-assertion of reset.

- Power-On Reset (POR) which resets the core, System Control Space and debug logic
- Local reset which resets the core and System Control Space except some debug associated resources

The Reset exception is permanently enabled, and has a fixed priority of -3.

NMI – Non Maskable Interrupt Non Maskable Interrupt is the highest priority exception other than reset. It is permanently enabled and has a fixed priority of -2.

HardFault HardFault is the generic fault that exists for all classes of fault that cannot be handled by any of the other exception mechanisms. HardFault will typically be used for unrecoverable system failure situations, though this is not required, and some uses of HardFault might be recoverable. HardFault is permanently enabled and has a fixed priority of -1.

HardFault is used for fault escalation,

MemManage The MemManage fault handles memory protection related faults which are determined by the Memory Protection Unit or by fixed memory protection constraints, for both instruction and data generated memory transactions. The fault can be disabled (in this case, a MemManage fault will escalate to HardFault). MemManage has a configurable priority.

BusFault The BusFault fault handles memory related faults other than those handled by the MemManage fault for both instruction and data generated memory transactions. Typically these faults will arise from errors detected on the system buses. Implementations are permitted to report synchronous or asynchronous BusFaults according to the circumstances that trigger the exceptions. The fault can be disabled (in this case, a BusFault will escalate to HardFault). BusFault has a configurable priority.

UsageFault The UsageFault fault handles non-memory related faults caused by the instruction execution. A number of different situations will cause usage faults, including:

- Undefined Instructions
- Invalid state on instruction execution
- Errors on exception return
- Disabled or unavailable coprocessor access

The following can cause usage faults when the core is configured to report them:

- Unaligned addresses on word and halfword memory accesses
- Division by zero

UsageFault has a configurable priority.

Debug Monitor Classified as a fault, debug monitor exceptions occur when halting debug is disabled, and debug monitor support is enabled. DebugMonitor has a configurable priority.

SVC This supervisor call handles the exception caused by the SVC instruction. SVC is permanently enabled and has a configurable priority.

Interrupts The ARMv7-M profile supports two system level interrupts – PendSV for software usage, and SysTick for a Timer integral to the ARMv7-M profile – along with up to 496 external interrupts. All interrupts have a configurable priority.

PendSV is permanently enabled. All other interrupts can be disabled. Interrupts can be set to or cleared from the Pending state by software, and interrupts other than PendSV can be set to the Pending state by hardware.

Exception Number Definition

All exceptions have an associated exception number as defined in Table B1-4.

Table B1-4 Exception Numbers

Exception number	Exception
1	Reset
2	NMI
3	HardFault
4	MemManage
5	BusFault
6	UsageFault
7-10	RESERVED
11	SVCcall
12	Debug Monitor
13	RESERVED
14	PendSV
15	SysTick
16	External Interrupt(0)
...	...
16 + N	External Interrupt(N)

The vector table

The vector table contains the initialisation value for the stack pointer on reset, and the entry point addresses for all exception handlers. The exception number (see above) defines the order of entries in the vector table associated with exception handler entry as illustrated in Table B1-59-4.

Table B1-5 Vector Table Format

word offset	Description – all pointer address values
0	SP_main (reset value of the Main stack pointer)
Exception Number	Exception using that Exception Number

Exception priorities and pre-emption

The priority algorithm treats lower numbers as taking higher precedence, that is, the lower the assigned value the higher the priority level. Exceptions assigned the same priority level adopt a fixed priority order for selection within the architecture according to their exception number.

Reset, non-maskable interrupts (NMI) and HardFault execute at fixed priorities of -3, -2, and -1 respectively. All other exception priorities can be set under software control and are cleared on reset.

The priorities of all exceptions are set in registers within the System Control Space (specifically, registers within the system control block and NVIC).

When multiple exceptions have the same priority number, the pending exception with the lowest exception number takes precedence. Once an exception is active, only exceptions with a higher priority (lower priority number) can pre-empt it.

For further details on priority support including priority grouping, priority escalation and pre-emption see the ARM core or device specification.

Reset Behavior

The assertion of reset causes the current execution state to be abandoned without being saved. On the de-assertion of reset, all registers controlled by the reset asserted contain their reset values.

For more details see the appropriate ARM core or device documentation.

Exception Entry Behavior

On pre-emption of an instruction stream, context state is saved by the hardware onto a stack pointed to by one of the SP registers (see *The SP registers* on page B1-7). The stack that is used depends on the mode of the processor at the time of the exception.

The stacked context supports the ARM Architecture Procedure Calling Standard (AAPCS). The support allows the exception handler to be an AAPCS-compliant procedure.

A full-descending stack format is used, where the stack pointer is decremented immediately before storing a 32-bit word (when pushing context) onto the stack, and incremented after reading a 32-bit word (popping context) from the stack. Eight 32-bit words are saved in descending order, with respect to their address in memory, as listed:

xPSR, ReturnAddress(), LR (R14), R12, R3, R2, R1, and R0

ReturnAddress() is the address to which execution will return after handling of the exception as defined below.

ReturnAddress()	returns the following values based on the exception cause
NMI:	Address of Next Instruction to be executed
HardFault (precise):	Address of the Instruction causing fault
HardFault (imprecise):	Address of Next Instruction to be executed
MemManage:	Address of the Instruction causing fault
BusFault (precise):	Address of the Instruction causing fault

BusFault (imprecise):	Address of Next Instruction to be executed
UsageFault:	Address of the Instruction causing fault
SVC:	Address of the Next Instruction after the SVC
DebugMonitor (precise):	Address of the Instruction causing fault
DebugMonitor (imprecise):	Address of Next Instruction to be executed
IRQ:	Address of Next Instruction to be executed

Note

IRQ includes SysTick and PendSV

Exception Return Behavior

Exception returns occur when one of the following instructions loads a value of 0xFFFFFFFF into the PC while in Handler mode:

- POP/LDM which includes loading the PC.
- LDR with PC as a destination.
- BX with any register.

When used in this way, the value written to the PC is intercepted and is referred to as the EXC_RETURN value.

EXC_RETURN<28:4> are reserved with the special condition that all bits should be written as one or preserved. Non-zero values are unpredictable.

When EXC_RETURN<31:4> are all ones, EXC_RETURN<3:0> provide return information as defined in Table B1-6.

Table B1-6 Exception return behavior

EXC_RETURN <3:0>	
0bXXX0	RESERVED
0b0001	Return to Handler Mode;Exception return gets state from the Main stack;On return execution uses the Main Stack
0b0011	RESERVED
0b01X1	RESERVED
0b1001	Return to Thread Mode;Exception return gets state from the Main stack;On return execution uses the Main Stack
0b1101	Return to Thread Mode;Exception return gets state from the Process stack;On return execution uses the Process Stack
0b1X11	RESERVED

Exception status and control

The System Control Block within the System Control Space (*The System Control Block (SCB)* on page B2-8) provides the register support required to manage the exception model.

For register details see the appropriate ARM core or device documentation.

Fault behavior

In accordance with the ARMv7-M exception priority scheme, precise fault exception handlers execute in one of the following ways:

- Taking the specified exception handler
- Taking a HardFault exception
- Adopt a lockup behavior associated with unrecoverable faults.

For more details see the appropriate ARM core or device documentation.

———— Note —————

The ARMv7-M profile generally assumes that when the processor is running at priority -1 or above, any faults or supervisor calls that occur are fatal and are entirely unexpected.

Reset management

For normal operation, the Application Interrupt and Reset Control register provides two mechanisms for a system reset:

- The control bit SYSRESETREQ requests a reset by an external system resource. The system components which are reset by this request are IMPLEMENTATION DEFINED, and in particular, it is IMPLEMENTATION DEFINED whether or not this causes a Local Reset.
- The control bit VECTRESET causes a Local Reset. It is IMPLEMENTATION DEFINED whether other parts of the system are reset as a result of this control.

In both cases, the reset is not guaranteed to take place immediately. A typical code sequence to synchronise reset following a write to the relevant control bit is:

```
        DSB
Loop   B   Loop
```

For more details see the appropriate ARM core or device documentation.

Reset and debug

Debug logic is fully reset by a Power-On Reset. Debug logic is only partially reset by a Local Reset. See *Debug and reset* on page C1-8 for details. Debuggers must only use VECTRESET when the core is halted, otherwise the effect is UNPREDICTABLE.

Power management

The ARMv7-M profile supports the use of *WFE* and *WFI* hints to suspend execution while waiting for events or interrupts. It is IMPLEMENTATION DEFINED what levels of power saving are used by implementations while execution is suspended in this way, provided that the state of the system is maintained. Code using *WFE* and *WFI* must handle spurious wakeup events as a result of a debug halt or other IMPLEMENTATION DEFINED reasons..

The Application Interrupt and Reset Control register provides control and configuration features.

For information on the differences and system related behavior of the *WFI* and *WFE* instructions, see *WFI* on page A5-319 and *WFE* on page A5-317.

For more details see the appropriate ARM core or device documentation.

Chapter B2

System Address Map

ARMv7-M is a memory mapped architecture. This chapter contains information on the system address map. It is designed to be read in conjunction with a device Technical Reference Manual (TRM). The TRM provides details for the device including the register definitions and their programming models. The chapter is made up of the following sections:

- *The system address map* on page B2-2
- *Bit Banding* on page B2-5
- *System Control Space (SCS)* on page B2-7
- *System timer - SysTick* on page B2-9
- *Nested Vectored Interrupt Controller (NVIC)* on page B2-10
- *Protected Memory System Architecture* on page B2-12

B2.1 The system address map

For ARMv7-M, the 32-bit address space is predefined, with subdivision for code, data, and peripherals, as well as regions for on-chip (tightly coupled to the core) and off-chip resources. The address space supports 8 x 0.5GB primary partitions:

- Code
- SRAM
- Peripheral
- 2 x RAM regions
- 2 x Device regions
- System

Physical addresses are architecturally assigned for use as event entry points (vectors), system control, and configuration. The event entry points are all with respect to a table base address, where the base address is automatically set to 0x00000000 on reset, then maintained in an address space reserved for system configuration and control. To meet this and other system needs, the address space 0xE0000000 to 0xFFFFFFFF is RESERVED for system level use.

Table B2-1 on page B2-3 describes the ARMv7-M default address map.

- XN refers to Execute Never for the region and will fault (MemManage exception) any attempt to execute in the region.
- The Cache column indicates inner/outer cache policy to support system caches. The policy allows a declared cache type to be demoted but not promoted.
WT: write through, can be treated as non-cached
WBWA: write-back, write allocate, can be treated as write-through or non-cached
- Shared indicates to the system that the access is intended to support shared use from multiple agents; multiple processors and/or DMA agents within a coherent memory domain.
- It is IMPLEMENTATION DEFINED which portions of the overall address space are designated read-write, which are read-only (for example Flash memory), and which are no-access (unpopulated parts of the address map).
- An unaligned or multi-word access which crosses a 0.5GB address boundary is UNPREDICTABLE.

For additional information on memory attributes and the memory model see Chapter A3 .

Table B2-1 ARMv7-M Address map

Start	Name	Device Type	XN	Cache	Description
0x00000000-0x1FFFFFFF	Code	Normal	-	WT	flash or other code. Implementation can use less, but must start this region at address 0x0.
0x20000000-0x3FFFFFFF	SRAM	Normal	-	WBWA	on-chip RAM. SRAM should be from base, other kinds can be offset
+0000000	SRAM_1M				1MB allocated as a primary bit-band region
+0100000	SRAM_31M				normal SRAM when used
+2000000	SRAM_bit-band	Internal			32MB aliased bit-band (bit-wise access) region
+4000000	SRAM				normal SRAM
0x40000000-0x5FFFFFFF	Peripheral	Device	XN	-	on-chip peripheral address space
+0000000	Periph_1M				1MB allocated as a primary bit-band region
+0100000	Periph_31M				normal peripheral space
+2000000	Periph_bit-band	Internal			32MB aliased bit-band (bit-wise access) region
+4000000	Peripheral				normal peripheral
0x60000000-0x7FFFFFFF	RAM	Normal	-	WBWA	memory with write-back, write allocate cache attribute for L2/L3 cache support
0x80000000-0x9FFFFFFF	RAM	Normal	-	WT	memory with write-thru cache attribute
0xA0000000-0xBFFFFFFF	Device	Device, shared	XN	-	shared device space
0xC0000000-0xDFFFFFFF	Device	Device	XN	-	non-shared device space

Table B2-1 ARMv7-M Address map

Start	Name	Device Type	XN	Cache	Description
0xE0000000-0xFFFFFFFF	System	-	XN	-	system segment for the PPB and vendor system peripherals
+0000000	PPB	SO, (shared)	XN		1MB region reserved as a Private Peripheral Bus. The PPB supports key resources including the System Control Space, and debug features.
+0100000	Vendor_SYS	Device	XN		vendor system. It is suggested that vendor resources start at 0xF0000000 (+GB offset).

To support a user (unprivileged) and supervisor (privileged) software model, a memory protection scheme is required to control the access rights. The Protected memory System Architecture for ARMv7-M (PMSAv7) is an optional system level feature described in *Protected Memory System Architecture* on page B2-12. An implementation of PMSAv7 is known as a Memory Protection Unit (MPU).

The address map described in Table B2-1 on page B2-3 is the default map for an MPU when it is disabled, and the only address map supported when no MPU is present. The default map can be enabled as a background region for privileged accesses when the MPU is enabled.

————— Note —————

When an MPU is enabled, the MPU is restricted in how it can change the default memory map attributes associated with System space (address 0xE0000000 or higher). System space is always marked as XN. System space which defaults to Device can be changed to Strongly-Ordered, but cannot be mapped to Normal memory. The PPB memory attributes cannot be remapped by an MPU.

B2.2 Bit Banding

The first 1MB of the SRAM and Peripheral partitions starting at addresses 0x20000000 and 0x40000000 respectively support the bit banding feature. The first 32MB of each partition supports byte/halfword/word and multi-word accesses. The next 32MB of each region supports bit-wise access of the first 1MB region. Within a partition, the offset address range 0x0-0xFFFFF is known as the primary bit-band address region, while the offset address range 0x2000000 to 0x3FFFFFF is known as the aliased bit-band address region.

Alias region accesses must use word, halfword or byte accesses from word-aligned addresses. All accesses to the aliased regions not meeting the type and address criteria stated are UNPREDICTABLE.

The bit-band alias regions map 1 word-per-bit against the 1MB primary regions in the SRAM and Peripheral partitions. That is, there are 8 words in the bit-band area for each byte in the lower SRAM and Peripheral areas; each word in the bit-band alias region operates on 1 bit in the corresponding byte in the primary bit-band region. The feature allows atomic access to each bit without special instructions. The bit-band feature can be used directly from C/C++ using pointers, static variables, or casted constants.

A bit-band alias location can be accessed as a byte, half-word, or word. The underlying access will be a byte, half-word, or word, aligned to the size of the access. This can be important for peripherals which can require accesses of a given size to operate correctly, and also handles big-endian effects. If the underlying peripheral bus does not support the access size, the bit-band operation is UNPREDICTABLE.

The mapping of a word address to a specific bit in memory can be calculated as follows.

For byte accesses:

```
bit_word_offset = (byte_offset * 32) + (bit_number * 4) (bit_number lies in the
range 0 to 7 inclusive)
```

For halfword accesses:

```
bit_word_offset = (halfword_offset * 64) + (bit_number * 4) (bit_number lies in
the range 0 to 15
inclusive)
```

For word accesses:

```
bit_word_offset = (word_offset * 128) + (bit_number * 4) (bit_number lies in
the range 0 to 31
inclusive)
```

In all cases:

```
bit_word_addr = bit_band_base + bit_word_offset
```

Bit_number is always in terms of the significance regardless of endianness. Bit_band_base is the starting address of the bit-band area (SRAM or peripheral space).

The bit_number is the relative bit position and is a function of the size of the access. If the bit_number is 0, it points to the least significant bit of the byte/halfword/word being accessed, while 7/15/31 point to the most significant bit of the byte/halfword/word respectively, regardless of the endianness of memory.

The following examples illustrate how the mapping is done.

Byte accesses:

- Word at 0x22000000 (offset 0 of bit-band for SRAM) references byte 0 bit 0 of the base data SRAM.
- Word at 0x2200001C (7th word) references byte 0 bit 7 of the base data SRAM.
- Word at 0x42000020 (8th word) references byte 1 bit 0 of the Peripheral area.

Word accesses:

- Word at 0x22000000 (offset 0 of bit-band for SRAM) references word 0 bit 0 of the base data SRAM.
- Word at 0x2200001C (7th word) references word 0 bit 7 of the base data SRAM.
- Word at 0x42000020 (8th word) references word 0 bit 8 of the Peripheral area.

The bit-band accesses are such that:

- A read of any bit-band location will return 0 or 1 (0x01, 0x0001, or 0x00000001).
- A write of any bit-band location will only use bit 0 of the written value and will apply that to the corresponding bit of the targeted byte, half-word, or word. By example, a write of 1 or 0xF will write a 1 to the addressed bit. A write of 0 or 0xE will write a 0 to the bit.

Writes to the bit-band are read-modify-write (atomic) with respect to the core. Atomic to the core means that writing a bit will perform a read of the underlying byte, half-word or word, set or clear the bit, and then write the modified byte, half-word or word back to the location read. The read-modify-write sequence is non-interruptible by external agents other than reset. Faults generated due to the sequence can occur. When a fault occurs the bit-band operation will not complete.

It is IMPLEMENTATION DEFINED if the operation is atomic in a multi-mastered system. Atomic in a multi-master system means that no other master (processor, DMA, etc) can modify the byte (or half-word or word) between the read and the write by the bit-band logic.

———— **Note** —————

Where a primary bit-band region is supported (in full or in part) in the system memory map, the associated aliased bit-band region must be supported. Where no primary region support exists, the corresponding aliased region must also be designated as non-existent memory.

B2.3 System Control Space (SCS)

The System Control Space is a memory-mapped 4kB address space which is used along with the special-purpose registers to provide arrays of 32-bit registers for configuration, status reporting and control. The SCS breaks down into the following groups:

- System Control/ID
- CPUID space
- System control, configuration and status
- Fault reporting
- A SysTick system timer
- A Nested Vectored Interrupt Controller (NVIC).
- A Protected Memory System Architecture (PMSAv7) – see *Protected Memory System Architecture* on page B2-12
- System debug – see Chapter C1 *Debug*

Table B2-2-2 defines the address space breakdown of the SCS register groups.

Table B2-2 SCS address space regions

System Control Space (address range 0xE000E000 to 0xE000EFFF)		
Group	Address Range(s)	Notes
System Control/ID	0xE000E000-0xE000E00F	includes the primary (CPUID) register and Interrupt Type register
	0xE000ED00-0xE000ED8F	System control block
	0xE000EF00-0xE000EFCF	includes the SW Trigger Exception register
	0xE000EFD0-0xE000EFFF	Microcontroller-specific ID space
SysTick	0xE000E010-0xE000E0FF	System Timer
NVIC	0xE000E100-0xE000ECCF	External interrupt controller
MPU	0xE000ED90-0xE000EDEF	Memory Protection Unit
Debug	0xE000EDF0-0xE000EEFF	Debug control and configuration

B2.3.1 The System Control Block (SCB)

Key control and status features of ARMv7-M are managed centrally in a System Control Block within the SCS. The SCB provides support for the following features:

- Software reset control at various levels
- Base address management (table pointer control) for the exception model
- System exception management (excludes external interrupts handled by the NVIC)
- Miscellaneous control and status features including coprocessor access support
- Power management – sleep support.
- Fault status information – see *Fault behavior* on page B1-14 for an overview of fault handling
- Debug status information – supplemented with control and status in the debug specific register region. See Chapter C1 *Debug* for debug details.

B2.4 System timer - SysTick

ARMv7-M includes an architected system timer – SysTick.

SysTick provides a simple, 24-bit clear-on-write, decrementing, wrap-on-zero counter with a flexible control mechanism. The counter can be used in several different ways, by example:

- An RTOS tick timer which fires at a programmable rate (for example 100Hz) and invokes a SysTick routine.
- A high speed alarm timer using Core clock.
- A variable rate alarm or signal timer – the duration range dependent on the reference clock used and the dynamic range of the counter.
- A simple counter. Software can use this to measure time to completion and time used.
- An internal clock source control based on missing/meeting durations. The COUNTFLAG bit-field in the control and status register can be used to determine if an action completed within a set duration, as part of a dynamic clock management control loop.

B2.4.1 Theory of operation

The timer consists of four registers:

- A control and status counter to configure its clock, enable the counter, enable the SysTick interrupt, and determine counter status.
- The reload value for the counter, used to provide the counter's wrap value.
- The current value of the counter.
- A calibration value register, indicating the preload value necessary for a 10ms (100Hz) system clock.

When enabled, the timer will count down from the reload value to zero, reload (wrap) to the value in the SysTick Reload Value register on the next clock edge, then decrement on subsequent clocks. Writing a value of zero to the Reload Value register disables the counter on the next wrap. When the counter reaches zero, the COUNTFLAG status bit is set. The COUNTFLAG bit clears on reads.

Writing to the Current Value register will clear the register and the COUNTFLAG status bit. The write does not trigger the SysTick exception logic. On a read, the current value is the value of the register at the time the register is accessed.

If the core is in debug state (halted), the counter will not decrement. The timer is clocked with respect to a reference clock. The reference clock can be the core clock or an external clock source.

B2.4.2 System timer register support in the SCS

For register details see the appropriate ARM core or device documentation.

B2.5 Nested Vectored Interrupt Controller (NVIC)

ARMv7-M provides an interrupt controller as an integral part of the ARMv7-M exception model. The interrupt controller operation aligns with ARM's General Interrupt Controller (GIC) specification, promoted for use with other architecture variants and ARMv7 profiles.

The ARMv7-M NVIC architecture supports up to 496 (IRQ[495:0]) discrete interrupts. The number of external interrupt lines supported can be determined from the read-only Interrupt Controller Type Register (ICTR) accessed at address 0xE000E004 in the System Control Space. The general registers associated with the NVIC are all accessible from a block of memory in the System Control Space as described in *System Control Space (SCS)* on page B2-7 .

B2.5.1 Theory of operation

ARMv7-M supports level-sensitive and pulse-sensitive interrupt behaviour. Pulse interrupt sources must be held long enough to be sampled reliably by the core clock to ensure they are latched and become Pending. A subsequent pulse can re-pend the interrupt while it is Active, however, multiple pulses which occur during the Active period will only register as a single event for interrupt scheduling.

In summary:

- Pulses held for a clock period will act like edge-sensitive interrupts. These can re-pend when the interrupt is Active.
- Level based interrupts will pend and activate the interrupt. The Interrupt Service Routine (ISR) can then access the peripheral, causing the level to be de-asserted. If the interrupt is still asserted on return from the interrupt, it will be pended again.

All NVIC interrupts have a programmable priority value and an associated exception number as part of the ARMv7-M exception model and its prioritisation policy.

The NVIC supports the following features:

- NVIC interrupts can be enabled and disabled by writing to their corresponding Interrupt Set-Enable or Interrupt Clear-Enable register bit-field. The registers use a write-1-to-enable and write-1-to-clear policy, both registers reading back the current enabled state of the corresponding (32) interrupts.

When an interrupt is disabled, interrupt assertion will cause the interrupt to become Pending, however, the interrupt will not activate. If an interrupt is Active when it is disabled, it remains in its Active state until cleared by reset or an exception return. Clearing the enable bit prevents new activations of the associated interrupt.

Interrupt enable bits can be hard-wired to zero where the associated interrupt line does not exist, or hard-wired to one where the associated interrupt line cannot be disabled.

- NVIC interrupts can be pended/un-pended using a complementary pair of registers to those used to enable/disable the interrupts, named the Set-Pending register and Clear-Pending register respectively. The registers use a write-1-to-enable and write-1-to-clear policy, both registers reading back the current pended state of the corresponding (32) interrupts. The Clear-Pending register has no effect on the execution status of an Active interrupt.

It is IMPLEMENTATION DEFINED for each interrupt line supported, whether an interrupt supports setting and/or clearing of the associated pend bit under software control.

- Active bit status is provided to allow software to determine whether an interrupt is Inactive, Active, Pending, or Active and Pending.
- NVIC interrupts are prioritised by updating an 8-bit field within a 32-bit register (each register supporting four interrupts). Priorities are maintained according to the ARMv7-M prioritisation scheme.

In addition to an external hardware event or setting the appropriate bit in the Set-Pending registers, an interrupt can be pended from software by writing its Exception Number to the Software Trigger Interrupt register.

B2.5.2 NVIC register support in the SCS

For register details see the appropriate ARM core or device documentation.

B2.6 Protected Memory System Architecture

To support a user (unprivileged) and supervisor (privileged) software model, a memory protection scheme is required to control the access rights. ARMv7-M supports the Protected Memory System Architecture (PMSAv7). The system address space of a PMSAv7 compliant system is protected by a Memory Protection Unit (MPU). The protected memory is divided up into a set of regions, with the number of regions supported IMPLEMENTATION DEFINED. While PMSAv7 supports region sizes as low as 32 bytes, finite register resources for the 4GB address space make the scheme inherently a coarse-grained protection scheme. The protection scheme is 100% predictive with all control information maintained in registers closely-coupled to the core. Memory accesses are only required for software control of the MPU register interface.

MPU support in ARMv7-M is optional, and co-exists with the system memory map described in *The system address map* on page B2-2 as follows:

- MPU support provides access right control on physical addresses. No address translation occurs in the MPU.
- When the MPU is disabled or not present, the system adopts the default system memory map listed in Table B2-1 on page B2-3. When the MPU is enabled, the enabled regions are used to define the system address map with the following provisos:
 - Accesses to the Private Peripheral Bus (PPB) always uses the default system address map.
 - Exception vector reads from the Vector Address Table always use the default system address map.
 - The MPU is restricted in how it can change the default memory map attributes associated with System space (address 0xE0000000 or higher). System space is always marked as XN (eXecute Never). System space which defaults to Device can be changed to Strongly-Ordered, but cannot be mapped to Normal memory.
 - Exceptions executing at a priority < 0 (NMI, HardFault, and FAULTMASK escalated handlers) can be configured to run with the MPU enabled or disabled.
 - The default system memory map can be configured to provide a background region for privileged accesses.
 - Accesses with an address match in more than one region use the highest matching region number for the access attributes.
 - Accesses which do not match the enabled regions generate a fault.

B2.6.1 PMSAv7 compliant MPU operation

ARMv7-M only supports a unified memory model with respect to MPU region support. All enabled regions provide support for instruction and data accesses.

The base address, size and attributes of a region are all configurable, with the general rule that all regions are naturally aligned. This can be stated as:

RegionBaseAddress[(N-1):0] = 0, where N is $\log_2(\text{SizeofRegion_in_bytes})$

Memory regions can vary in size as a power of 2. The supported sizes are 2^N , where $5 \leq N \leq 32$. Where there is an overlap between two regions, the register with the highest region number takes priority.

Sub-region support

For regions of 256 bytes or larger, the region can be divided up into eight sub-regions of size $2^{(N-3)}$. Sub-regions within a region can be disabled on an individual basis (8 disable bits) with respect to the associated region attribute register. When a sub-region is disabled, an access match is required from another region, or background matching if enabled. If an access match does not occur a fault is generated. Region sizes below 256 bytes do not support sub-regions. The sub-region disable field is SBZ/UNP for regions of less than 256 bytes in size.

ARMv7-M specific support

ARMv7-M supports the standard PMSAv7 memory model, plus the following extensions:

- An optimised two register update model, where the region being updated can be selected by writing to the MPU Region Base Address register. This optimisation applies to the first sixteen memory regions ($0 \leq \text{RegionNumber} \leq 0xF$) only.
- The MPU Region Base Address register and the MPU Region Attribute and Size register pairs are aliased in three consecutive dual-word locations. Using the two register update model, up to four regions can be modified by writing the appropriate even number of words using a single *STM* multi-word store instruction.

B2.6.2 Register support for PMSAv7 in the SCS

For register details see the appropriate ARM core or device documentation.

Chapter B3

ARMv7-M System Instructions

As previously stated, ARMv7-M only executes instructions in Thumb state. The full list of supported instructions is provided in *Alphabetical list of Thumb instructions* on page A5-16. To support reading and writing the special-purpose registers under software control, ARMv7-M provides three system instructions:

CPS

MRS

MSR

B3.1 Alphabetical list of ARMv7-M system instructions

The ARMv7-M system instructions are defined in this section:

- *CPS* on page B3-3
- *MRS* on page B3-5
- *MSR (register)* on page B3-9

B3.1.1 CPS

Change Processor State changes one or more of the special-purpose register PRIMASK and FAULTMASK values.

Encoding

T1 CPS<effect> <iflags> Not allowed in IT block.

15	14	13	12	11	10	9	8	7	6	5	4	3	2	1	0
1	0	1	1	0	1	1	0	0	1	1	im	0	(0)	I	F

```
enable = (im == '0');  disable = (im == '1');
affectPRI = (I == '1');  affectFAULT = (F == '1');
if InITBlock() then UNPREDICTABLE;
```

Architecture versions

Encoding T1 ARMv7-M specific encoding. The instruction exists in all versions of the Thumb instruction set from v6.

Assembler syntax

CPS<effect><q> <iflags>

where:

- <effect> Specifies the effect required on PRIMASK and FAULTMASK. This is one of:
- IE Interrupt Enable. This sets the specified bits to 0.
 - ID Interrupt Disable. This sets the specified bits to 1.
- <q> See *Standard assembler syntax fields* on page A5-6.
- <iflags> Is a sequence of one or more of the following, specifying which masks are affected:
- i PRIMASK. Raises the current priority to 0 when set to 1. This is a 1-bit register, which supports privileged access only.
 - f FAULTMASK. Raises the current priority to -1 (the same as HardFault) when it is set to 1. This is a 1-bit register, which can only be set by privileged code with a lower priority than -1. The register self-clears on return from any exception other than NMI.

Operation

```
EncodingSpecificOperations();
if CurrentModeIsPrivileged() then
    if enable then
        if affectPRI then PRIMASK = '0';
        if affectFAULT then FAULTMASK = '0';
    if disable then
        if affectPRI then PRIMASK = '1';
        if affectFAULT and ExecutionPriority > -1 then FAULTMASK = '1';
```

Exceptions

None.

Notes

Privilege Any User mode code attempt to write the masks is ignored.

Masks and CPS

The CPSIE and CPSID instructions are equivalent to using an MSR instruction:

- The CPSIE *i* instruction is equivalent to writing a 0 into PRIMASK
- The CPSID *i* instruction is equivalent to writing a 1 into PRIMASK
- The CPSIE *f* instruction is equivalent to writing a 0 into FAULTMASK
- The CPSID *f* instruction is equivalent to writing a 1 into FAULTMASK.

Assembler syntax

MRS<c><q> <Rd>, <spec_reg>

where:

<c><q> See *Standard assembler syntax fields* on page A5-6.

<Rd> Specifies the destination register.

<spec_reg> Encoded in SYSm, specifies one of the following:

Special register	Contents	SYSm value
APSR	The flags from previous instructions	0
IAPSR	A composite of IPSR and APSR	1
EAPSR	A composite of EPSR and APSR	2
XPSR	A composite of all three PSR registers	3
IPSR	The Interrupt status register	5
EPSR	The execution status register	6
IEPSR	A composite of IPSR and EPSR	7
MSP	The Main Stack pointer	8
PSP	The Process Stack pointer	9
PRIMASK	Register to mask out configurable exceptions	16 ^a
BASEPRI	The base priority register	17 ^b
BASEPRI_MAX	This acts as an alias of BASEPRI on reads	18 ^c
FAULTMASK	Register to raise priority to the HardFault level	19 ^d
CONTROL	The special-purpose control register	20 ^e
RSVD	RESERVED	unused

- a. Raises the current priority to 0 when set to 1. This is a 1-bit register.
- b. Changes the current pre-emption priority mask to a value between 0 and N. 0 means the mask is disabled. The register only has an effect when the value (1 to N) is lower (higher priority) than the non-masked priority level of the executing instruction stream. The register can have up to 8 bits (depending on the number of priorities supported), and it is formatted exactly the same as other priority registers. The register is affected by the PRIGROUP (binary point) field. See *Exception priorities and pre-emption* on page B1-12 for more details. Only the pre-emption part of the priority is used by BASEPRI for masking.

- c. When used with the MSR instruction, it performs a conditional write.
- d. This register raises the current priority to -1 (the same as HardFault) when it is set to 1. This can only be set by privileged code with a priority below -1 (not NMI or HardFault), and self-clears on return from any exception other than NMI. This is a 1-bit register.
- e. The control register is composed of the following bits:
 - [0] = Thread mode privilege: 0 means privileged, 1 means unprivileged (User). This bit resets to 0 .
 - [1] = Current stack pointer: 0 is Main stack (MSP), 1 is alternate stack (PSP if Thread mode, RESERVED if Handler mode). This bit resets to 0.

Operation

```

if ConditionPassed() then
    R[d] = 0;
    case SYSm<7:3> of
        when '00000'
            if SYSm<0> == '1' and CurrentModeIsPrivileged() then
                R[d]<8:0> = IPSR;
            if SYSm<1> == '1' then
                R[d]<26:24> = '000'; /* EPSR reads as zero */
                R[d]<15:10> = '000000';
            if SYSm<2> == '0' then
                R[d]<31:27> = APSR;
        when '00001'
            if CurrentModeIsPrivileged() then
                case SYSm<2:0> of
                    when '000'
                        R[d] = MSP;
                    when '001'
                        R[d] = PSP;
        when '00010'
            case SYSm<2:0> of
                when '000'
                    R[d]<0> = if CurrentModeIsPrivileged() then
                        PRIMASK else '0';
                when '001'
                    R[d]<7:0> = if CurrentModeIsPrivileged() then
                        BASEPRI else '00000000';
                when '010'
                    R[d]<7:0> = if CurrentModeIsPrivileged() then
                        BASEPRI else '00000000';
                when '011'
                    R[d]<0> = if CurrentModeIsPrivileged() then
                        FAULTMASK else '0';
                when `100`
                    R[d]<1:0> = CONTROL;

```

Exceptions

None.

Notes

- Privilege** If User code attempts to read any stack pointer or the IPSR, it returns 0s.
- EPSR** None of the EPSR bits are readable during normal execution. They all read as 0 when read using MRS (Halting debug can read them via the register transfer mechanism).
- Bit positions** The PSR bit positions are defined in *The special-purpose processor status registers (xPSR)* on page B1-7.

B3.1.3 MSR (register)

Move to Special Register from ARM Register moves the value of a general-purpose register to the selected special-purpose register.

Encodings

T1 MSR<c> <spec_reg>, <Rn>

15	14	13	12	11	10	9	8	7	6	5	4	3	2	1	0	15	14	13	12	11	10	9	8	7	6	5	4	3	2	1	0
1	1	1	1	0	0	1	1	1	0	0	0	Rn				1	0	(0)	0	1	0	0	0	SYSm							

```
n = UInt(Rn);
if BadReg(d) then UNPREDICTABLE;
```

Architecture versions

Encoding T1 ARMv7-M specific encoding. The instruction exists in all architecture variants, and in the Thumb instruction set from Thumb-2 onwards.

Assembler syntax

MSR<c><q> <spec_reg>, <Rn>

where:

<c><q> See *Standard assembler syntax fields* on page A5-6.

<Rn> Is the general-purpose register to receive the special register contents.

<spec_reg> Encoded in SYSm, specifies one of the following:

Special register	Contents	SYSm value
APSR	The flags from previous instructions	0
IAPSR	A composite of IPSR and APSR	1
EAPSR	A composite of EPSR and APSR	2
XPSR	A composite of all three PSR registers	3
IPSR	The Interrupt status register	5
EPSR	The execution status register (reads as zero, see Notes)	6
IEPSR	A composite of IPSR and EPSR	7

Special register	Contents	SYSm value
MSP	The Main Stack pointer	8
PSP	The Process Stack pointer	9
PRIMASK	Register to mask out configurable exceptions	16 ^a
BASEPRI	The base priority register	17 ^b
BASEPRI_MAX	On writes, raises BASEPRI but does not lower it	18 ^c
FAULTMASK	Register to raise priority to the HardFault level	19 ^d
CONTROL	The special-purpose control register	20 ^e
RSVD	RESERVED	unused

- a. Raises the current priority to 0 when set to 1. This is a 1-bit register.
- b. Changes the current pre-emption priority mask to a value between 0 and N. 0 means the mask is disabled. The register only has an effect when the value (1 to N) is lower (higher priority) than the non-masked priority level of the executing instruction stream. The register can have up to 8 bits (depending on the number of priorities supported), and it is formatted exactly the same as other priority registers. The register is affected by the PRIGROUP (binary point) field. See *Exception priorities and pre-emption* on page B1-12 for more details. Only the pre-emption part of the priority is used by BASEPRI for masking.
- c. When used with the MSR instruction, it performs a conditional write. The BASEPRI value is only updated if the new priority is higher (lower number) than the current BASEPRI value. Zero is a special value for BASEPRI (it means disabled). If BASEPRI is 0, it always accepts the new value. If the new value is 0, it will never accept it. This means BASEPRI_MAX can always enable BASEPRI but never disable it. PRIGROUP has no effect on the values compared or written. All register bits are compared and conditionally written.
- d. This register raises the current priority to -1 (the same as HardFault) when it is enabled set to 1. This can only be set by privileged code with a priority below -1 (not NMI or HardFault), and self-clears on return from any exception other than NMI. This is a 1-bit register. The CPS instruction can also be used to update the FAULTMASK register.
- e. The control register is composed of the following bits:
 - [0] = Thread mode privilege: 0 means privileged, 1 means unprivileged (User). This bit resets to 0.
 - [1] = Current stack pointer: 0 is Main stack (MSP), 1 is alternate stack (PSP if Thread mode, RESERVED if Handler mode). This bit resets to 0.

Operation

```

if ConditionPassed() then
  case SYSm<7:3> of
    when '00000'
      if SYSm<2> == '0' then
        APSR = R[n]<31:27>;
    when '00001'
      if CurrentModeIsPrivileged() then
        case SYSm<2:0> of
          when '000'
            MSP = R[n];
          when '001'
            PSP = R[n];
    when '00010'
      case SYSm<2:0> of
        when '000'
          if CurrentModeIsPrivileged() then PRIMASK = R[n]<0>;
        when '001'
          if CurrentModeIsPrivileged() then BASEPRI = R[n]<7:0>;
        when '010'
          if CurrentModeIsPrivileged() &&
            (R[n]<7:0> != '00000000') &&
            (R[n]<7:0> < BASEPRI || BASEPRI == '00000000') then
            BASEPRI = R[n]<7:0>;
        when '011'
          if CurrentModeIsPrivileged() &&
            (ExecutionPriority > -1) then
            FAULTMASK = R[n]<0>;
        when `100`
          if CurrentModeIsPrivileged() then
            CONTROL<0> = R[n]<1:0>;
            If Mode == Thread then CONTROL<1> = R[n]<1>;

```

Exceptions

None.

Notes

- Privilege** Writes from unprivileged Thread mode to any stack pointer, the EPSR, the IPSR, the masks, or CONTROL, will be ignored. If privileged Thread mode software writes a 0 into CONTROL[0], the core will switch to unprivileged Thread mode (User) execution, and inhibit further writes to special-purpose registers. An ISB instruction is required to ensure instruction fetch correctness following a Thread mode privileged => unprivileged transition.
- IPSR** The currently defined IPSR fields are not writable. Attempts to write them by Privileged code is write-ignored (has no effect).

- EPSR** The currently defined EPSR fields are not writable. Attempts to write them by Privileged code is write-ignored (has no effect).
- Bit positions** The PSR bits are positioned in each PSR according to their position in the larger xPSR composite. This is defined in *The special-purpose processor status registers (xPSR)* on page B1-7.

Part C

Debug

Chapter C1

Debug

This chapter provides a summary of the debug features supported in ARMv7-M. It is designed to be read in conjunction with a device Technical Reference Manual (TRM). The TRM provides details on the debug provisions for the device including the register interfaces and their programming models. This chapter is made up of the following sections:

- *Introduction to debug* on page C1-2
- *The Debug Access Port (DAP)* on page C1-4
- *Overview of the ARMv7-M debug features* on page C1-7
- *Debug and reset* on page C1-8
- *Debug event behavior* on page C1-9
- *Debug register support in the SCS* on page C1-11
- *Instrumentation Trace Macrocell (ITM) support* on page C1-12
- *Data Watchpoint and Trace (DWT) support* on page C1-14
- *Embedded Trace (ETM) support* on page C1-15
- *Trace Port Interface Unit (TPIU)* on page C1-16
- *Flash Patch and Breakpoint (FPB) support* on page C1-17.

This chapter is profile specific. ARMv7-M includes several debug features unique within the ARMv7 architecture to this profile.

C1.1 Introduction to debug

Debug support is a key element of the ARM architecture. ARMv7-M provides a range of debug approaches, both invasive and non-invasive techniques.

Invasive debug techniques are:

- the ability to halt the core, execute to breakpoints etc. (run-stop model)
- debug code using the DebugMonitor exception (less intrusive than halting the core).

Non-invasive debug techniques are:

- application trace by writing to the Instrumentation Trace Macrocell (ITM), a very low level of intrusion
- non-intrusive hardware supported trace and profiling,

Debug is normally accessed via the DAP (see *The Debug Access Port (DAP)* on page C1-4), which allows access to debug and system memory whether the processor is running, halted, or held in reset. When a core is halted, the core is in debug state.

The software-based and non-intrusive hardware debug features supported are as follows:

- High level trace and logging using the Instrumentation Trace Macrocell (ITM). This uses a fixed low-intrusion overhead (non-blocking register writes) which can be added to an RTOS, application or exception handler/ISR. The instructions can be retained in product code avoiding probe effects where necessary.
- Profiling a variety of system events including associated timing information. These include monitoring core clock counts associated with interrupt and sleep functions.
- PC sampling and event counts associated with load/store, instruction folding, and CPI statistics.
- Data tracing.

As well as the Debug Control Block (DCB) within the System Control Space (SCS), other debug related resources are allocated fixed 4kB address regions within the Private Peripheral Bus (PPB) region of the ARMv7-M system address map:

- Instrumentation Trace Macrocell (ITM) for profiling software.
- Watchpoint support and embedded trace trigger control are supported by the Debug Watchpoint and Trace (DWT) block. This block also provides program counter sampling support for performance monitoring.
- A Flash Patch and Breakpoint (FPB) control block is defined that can remap sections of ROM (Flash memory) to regions of RAM. This feature can be used for debug and provision of code and/or data patches to applications where updates or corrections to product ROM(s) are required in the field.
- Additional regions for supporting trace management beyond trigger control.
- A table of entries providing an ID mechanism on the debug infrastructure supported by the implementation.

The address ranges for the ITM, DWT, FPB, DCB and trace support are listed in Table C1-1.

Table C1-1 PPB debug related regions

Private Peripheral Bus (address range 0xE0000000 to 0xE00FFFFF)		
Group	Address Offset Range(s)	Notes
Instrumentation Trace Macrocell (ITM)	0x0000–0x0FFF	profiling and performance monitor support
Data Watchpoint and Trace (DWT)	0x1000–0x1FFF	includes control for trace support
Flash Patch and Breakpoint (FPB)	0x2000–0x2FFF	
SCS: System Control Block (SCB)	0xED00–0xED8F	SCB: generic control features
SCS: Debug Control Block (DCB)	0xEDF0–0xEEFF	Debug control and configuration
Trace Port Interface Unit (TPIU)	0x40000–0x40FFF	Optional trace and/or serial wire viewer support (see notes).
Embedded Trace Macrocell (ETM)	0x41000–0x41FFF	Optional instruction trace capability
ARMv7-M ROM table	0xFF000–0xFFFFF	DAP accessible for autoconfiguration

Notes on Table C1-1:

- The SCB is described in *The System Control Block (SCB)* on page B2-8.
- In addition to the DWT and ITM, a TPIU is needed for data trace, application trace, and profiling.
- The TPIU can be a shared resource in a complex debug system, or omitted where visibility of ITM stimuli, or ETM and DWT trace event output is not required. Where the TPIU is a shared resource, it can reside within the PPB memory map and under local cpu control, or be an external system resource, controlled from elsewhere.

C1.2 The Debug Access Port (DAP)

Debug access is through the Debug Access Port (DAP). A JTAG Debug Port (JTAG-DP) or Serial Wire Debug Port (SW-DP) can be used. The DAP specification includes details on how a system can be interrogated to determine what debug resources are available, and how to access any ARMv7-M device(s) within the debug fabric. A valid ARMv7-M system instantiation includes a ROM table of information as described in Table C1-3. The general format of a ROM table entry is described in Table C1-2.

A debugger can use a DAP interface to interrogate a system for memory access ports (MEM-APs). The BASE register in a memory access port provides the address of the ROM table (or a series of ROM tables within a ROM table hierarchy). The memory access port can then be used to fetch the ROM table entries.

Table C1-2 ROM table entry format

Bits	Name	Description
[31:12]	Address offset	Signed base address offset of the component relative to the ROM base address
[11:2]	Reserved	SBZP/UNP
[1]	Format	1: 32-bit format 0: 8-bit format (not used by ARMv7-M)
[0]	Entry present	Set if a valid entry, the last entry has 0x00000000 (reserved)

For ARMv7-M all address offsets are negative.

Table C1-3 ARMv7-M DAP accessible ROM table

Offset	Value	Name	Description
0x000	0xFFFF0F003	SCS	Points to the SCS at 0xE000E000.
0x004	0xFFFF02003	DWT	Points to the Data Watchpoint and Trace block at 0xE0001000.
0x008	0xFFFF03003	FPB	Points to the Flash Patch and Breakpoint block at 0xE0002000.
0x00C	0xFFFF01003	ITM	Points to the Instrumentation Trace block at 0xE0000000.
0x010	0xFFFF41002 or 0xFFFF41003	TPIU	Points to the TPIU. Bit[0] is set if a TPIU is fitted.
0x014	0xFFFF42002 or 0xFFFF42003	ETM	Points to the ETM. Bit[0] is set if an ETM is fitted.
0x018	0	end	End-of-table marker. It is IMPLEMENTATION DEFINED whether the table is extended with pointers to other system debug resources. The table entries always terminate with a null entry.

Table C1-3 ARMv7-M DAP accessible ROM table (continued)

Offset	Value	Name	Description
0xFCC	Bit[0]	MEMTYPE	Bits[31:1] RAZ. Bit[0] is set when the system memory map is accessible via the DAP. Bit[0] is clear when only debug resources are accessible via the DAP.
0xFD0	IMP DEF	PID4	CIDx values are fully defined for the ROM table, and are CoreSight compliant.
0xFD4	0	PID5	
0xFD8	0	PID6	CoreSight: ARM's system debug architecture
0xFDC	0	PID7	
0xFE0	IMP DEF	PID0	
0xFE4	IMP DEF	PID1	
0xFE8	IMP DEF	PID2	
0xFEC	IMP DEF	PID3	
0xFF0	0x0000000D	CID0	
0xFF4	0x00000010	CID1	
0xFF8	0x00000005	CID2	
0xFFC	0x000000B1	CID3	

The basic sequence of events to access and enable ARMv7-M debug using a DAP is as follows:

- Enable the power-up bits for the debug logic in the appropriate DAP control register.
- Ensure the correct DAP path is enabled for word accesses (this should be the default in a uniprocessor system).
- Set the C_DEBUGEN bit in the Debug Halting Control and Status register (DHCSR) where halting debug is required. Set the C_HALT bit in the same register if the requirement is for the target to halt immediately.
- Read back the S_HALT bit in the DHCSR to ensure the target is halted in debug state.
- If using the trace features, set the TRCENA bit in the Debug Exception and Monitor Control register (DEMCR). DebugMonitor exceptions are enabled in the DEMCR, subject to a precedence rule that C_DEBUGEN is clear.

Warning

System control and configuration fields (in particular registers in the SCB) can be changed via the DAP while software is executing. For example, resources designed for dynamic updates can be modified, but can have undesirable side-effects if both the application and debugger are updating the same or related resources. The consequences of updating a running system via a DAP in this manner have no guarantees, and can be worse than UNPREDICTABLE with respect to system behavior.

In general, MPU or FPB address remapping changes should not be performed by a debugger while software is running to avoid associated context problems.

C1.2.1 General rules applying to debug register access

The Private Peripheral Bus (PPB), address range 0xE0000000 to 0xE0100000, supports the following general rules:

- The region is defined as Strongly Ordered memory – see *Strongly Ordered memory attribute* on page A3-24 and *Memory access restrictions* on page A3-24.
- Registers are always accessed little endian regardless of the endian state of the processor.
- Registers can be accessed as byte, halfword, word, dual-word or mult-word quantities unless a register definition specifically states otherwise. Several registers are a concatenation of byte aligned bit fields affecting different resources. In these cases, registers can be declared as 8-bit or 16-bit registers with an appropriate address offset within the 32-bit register base address.
- The term set means assigning the value to 1, and the term clear(ed) means assigning the value to 0. Where the term applies to multiple bits, all bits assume the assigned value.
- The term disable means assigning the bit value to 0, the term enable means assigning the bit value to 1.
- A reserved register or bit field assumes the value SBZP/UNP.

Unprivileged (User) access to the PPB causes BusFault errors unless otherwise stated. Notable exceptions are:

- Unprivileged accesses can be enabled to the Software Trigger Interrupt register in the System Control Space by programming a control bit in the Configuration Control register.
- For debug related resources (DWT, ITM, FPB, ETM and TPIU blocks), user access reads are UNKNOWN and writes are ignored unless stated otherwise.

C1.3 Overview of the ARMv7-M debug features

ARMv7-M defines a purpose-built debug model with control and configuration integrated into the ARMv7-M memory map. The Debug Access Port provides the interface to a host debugger. Debug resources within ARMv7-M are as listed in Table C1-1 on page C1-3.

ARMv7-M supports the following debug related features:

- A Local Reset, see *Overview of the Exceptions Supported* on page B1-9. This resets the core and supports debug of reset events.
- Core halt. Control register support to halt the core. This can occur asynchronously by assertion of an external signal, execution of a BKPT instruction, or from a debug event (by example configured to occur on reset, or on exit from or entry to an ISR).
- Step. ARMv7-M supports two step-instruction functions: with interrupts taken or chained to, and without.
- Run, either with interrupts taken or chained to, or without.
- Register access. The DCB supports debug requests, including reading and writing core registers when halted.
- Access to exception-related information through the SCS resources. Examples are the currently executing exception (if any), the active list, the pended list, and the highest priority pending exception.
- Breakpoint software control. The BKPT instruction is supported.
- Flash patch support for hardware breakpoints and/or remapping of memory locations.
- Access to all memory can be provided through the DAP.
- Support of Profiling. A hardware-triggered PC-sampler is provided.
- Support of ETM Trace and the ability to add other system debug features such as a bus monitor or cross-trigger facility. ETM trace requires a multiwire TPIU.
- A Serial Wire Viewer (SWV) can be used for application trace (ITM) support plus data tracing and profiling (DWT resources).

Note

CoreSight is the name given to ARM's system debug architecture, incorporating a range of debug control, capture and system interface blocks. ARMv7-M does not require CoreSight compliance. The register definitions and address space allocations for the DWT, ITM, TPIU and FPB blocks in this specification are compatible. Blocks can be replaced or enhanced to support CoreSight topology detection and operation as appropriate by extending them with CoreSight ID and management registers.

C1.4 Debug and reset

ARMv7-M defines two levels of reset as stated in *Overview of the Exceptions Supported* on page B1-9. Once the reset handler has started executing, the core can Halt (enter debug state). The vector catch control bit (VC_CORESET) in the Debug Exception and Monitor Control register can be used to generate a debug event when the core comes out of reset.

A Local Reset, caused by an application or debugger as described in *Reset Behavior* on page B1-12, will take the processor out of debug state and clear the following debug register control bits:

- C_HALT in the Debug Halting Control and Status register (DHCSR).
- The MON_XXX bits in the Debug Exception and Monitor Control register (DEMCR).

———— **Note** —————

1. ARMv7-M does not provide a means to debug a Power-On Reset.
2. ARMv7-M does not provide a means to detect Power-On Reset vs. a Local Reset.

Support of the debug logic reset and power control signals described in the DAP recommended external interface are IMPLEMENTATION DEFINED. Where the DAP signals are not present, the following behaviour is defined for ARMv7-M:

- The debug logic is reset according to the ARMv7-M specific definitions.
- The debug logic is always powered up.

C1.5 Debug event behavior

An event triggered for debug reasons is known as a debug event. A debug event will cause one of the following to occur:

- Entry to debug state. If halting debug is enabled (C_DEBUGEN in the DHCSR is set), captured events will halt the processor in debug state.
- A DebugMonitor exception. If halting debug is disabled (C_DEBUGEN is cleared) and the debug monitor is enabled (MON_EN in the DEMCR is set), a debug event will cause a DebugMonitor exception when the group priority of DebugMonitor is higher than the current active group priority. If the DebugMonitor group priority is less than or equal to the current active group priority, a BKPT instruction will escalate to a HardFault and other debug events (watchpoints and external debug requests) are ignored.

———— **Note** —————

Software can put the DebugMonitor exception into the Pending state under this condition, and when the DebugMonitor exception is disabled.

- If both halting debug and the monitor are disabled, a BKPT instruction will escalate to a HardFault and other debug events (watchpoints and external debug requests) are ignored.
- A BKPT instruction in a HardFault or NMI handler is considered as unrecoverable.

The Debug Fault Status register (DFSR) contains status bits for each captured debug event. The bits are write-one-to-clear. These bits are set when a debug event causes the processor to halt or generate an exception. It is IMPLEMENTATION DEFINED if the bits are updated when an event is ignored.

A summary of halting and debug monitor support is provided in Table C1-4.

Table C1-4 Debug related faults

Fault Cause	Exception support(Halt and DebugMonitor)	DFSR Bit Name	Notes
Internal halt request	Yes	HALTED	Step command, core halt request, etc.
Breakpoint	Yes	BKPT	SW breakpoint from patched instruction or FPB

Table C1-4 Debug related faults (continued)

Fault Cause	Exception support(Halt and DebugMonitor)	DFSR Bit Name	Notes
Watchpoint	Yes	DWTTRAP	Watchpoint match in DWT
Vector catch	Halt only	VCATCH	VC_xxx bit(s) or RESETVCATCH set
External	Yes	EXTERNAL	EDBGRRQ line asserted

For a description of the vector catch feature, see *Vector catch support* on page C1-11.

C1.5.1 Debug stepping

ARMv7-M supports debug stepping in both halting debug and monitor debug. Stepping from debug state is supported by writing to the C_STEP and C_HALT control bits in the Debug Halt Control and Status register (DHCSR). See Table C1-5 for a summary of stepping control.

Table C1-5 Debug stepping control using the DHCSR

DHCSR writes ^a			
C_HALT	C_STEP	C_MASKINTS	Action
0	0	x	debug state => system running
0	1	0	exit debug state, step instruction, and halt
0	1	1	exit debug state, execute instruction and permitted activated exceptions, then halt
1	x	x	system remains in debug state - halted

a. assumes C_DEBUGEN == 1 and C_HALT == 1 when the write occurs (the system is halted).

Modifying C_STEP or C_MASKINTS while the system is running with halting debug support enabled (C_DEBUGEN == 1, S_HALT == 0) is UNPREDICTABLE.

Stepping in a debug monitor is supported by the MON_STEP control bit in the Debug Exception and Monitor Control register (DEMCR). When MON_STEP is set (with C_DEBUGEN clear), the step request will occur on return from the DebugMonitor handler to the code being debugged. After executing one instruction, the DebugMonitor exception will be taken with the DFSR HALTED bit set.

C1.6 Debug register support in the SCS

The debug provision in the System Control Block consists of two handler-related flag bits (ISRPREEMPT and ISRPENDING) in the Interrupt Control State register (ICSR) and the Debug Fault Status register.

Additional debug registers are architected in the Debug Control Block as summarised in Table C1-6.

Table C1-6 Debug register region of the SCS

Address	R/W	Function
0xE000EDF0	R/W	Debug Halting Control and Status Register
0xE000EDF4	WO	Debug Core Register Transfer Selector Register
0xE000EDF8	R/W	Debug Core Register Data Register
0xE000EDFC	R/W	Debug Exception and Monitor Control Register
... to 0xE000EEFF	...	Reserved for debug extensions

For register details see the appropriate ARM core or device documentation.

C1.6.1 Vector catch support

Vector catch support is the mechanism used to generate a debug event and enter debug state when a particular exception occurs. Vector catching is semi-synchronous and only supported by halting debug.

If any of the fault status bits associated with an enabled vector catch is set, and the associated exception activates, then a debug event occurs. This causes Debug state to be entered (execution halted) on the 1st instruction of the exception handler.

C1.7 Instrumentation Trace Macrocell (ITM) support

The Instrumentation Trace Macrocell (ITM) provides a register-based interface to allow applications to write logging/event words to the optional external interface (TPIU). The ITM also supports control and generation of timestamp information packets.

The event words and timestamp information are formed into packets and multiplexed with hardware event packets from the Data Watchpoint and Trace (DWT) block.

C1.7.1 Theory of operation

The ITM consists of stimulus registers, stimulus enable (Trace Enable) registers, a stimulus access (Trace Privilege) register, and a general control (Trace Control) register. The number of stimulus registers is IMPLEMENTATION DEFINED.

The Trace Privilege register defines whether the associated stimulus registers and their corresponding Trace Enable register bits can be written by an unprivileged (User) access. User code can always read the stimulus registers.

Stimulus registers are 32-bit registers that support word-aligned (address[1:0] == 0b00) byte (bits[7:0]), halfword (bits[15:0]), or word accesses. Non-word-aligned accesses are UNPREDICTABLE. There is a global enable in the control register and additional mask bits, which enable the stimulus registers individually, in the Trace Enable register.

When an enabled stimulus register is written to, the identity of the register, the size of the write access, and the data written are copied into a Stimulus Port FIFO for emission through a Trace Port Interface Unit (TPIU).

Writes to the stimulus port are ignored when the FIFO is full. Reads of a stimulus port indicate the port's FIFO status. FIFO status reads as FIFO-FULL after a power-on reset, and when ITMENA or the Stimulus port's enable bit is clear.

————— **Note** —————

To ensure system correctness, a software polling scheme can use exclusive accesses to manage stimulus register writes with respect to the Stimulus Port FIFO status.

The following example polled code ensures a stimulus is not lost when written to an enabled stimulus port:

```

; exclusive monitor cleared on exception entry
; R0 = ITM enabled/FIFO-full/exclusive status
; R1 = base of ITM stimulus ports
; R2 = value to be written      LDR    R0, [R1, #TraceControl_reg_offset];read
TCR (ITM control reg)
CBZ R0, continue      ;check ITM (implicit TRCENA check) enabledretry
LDREX R0, [R1, #stim_reg_offset] ;read FIFO status and request exclusive lock
CBZ  R0, retry      ;FIFO not ready, try again
STREX R0, R2, [R1, #stim_reg_offset] ;store if FIFO !Full and exclusive lock
CBNZ R0, retry      ;exclusive lock failed, try againcontinue

```

All ITM registers can be read by unprivileged (User) and privileged code at all times. Privileged write accesses are ignored unless ITMENA is set. Unprivileged write accesses to the Trace Control and Trace Privilege registers are always ignored. Unprivileged write accesses to the Stimulus Port and Trace Enable registers are allowed or ignored according to the setting in the Trace Privilege register. Trace Enable registers are byte-wise enabled for user access, according to the Trace Privilege register setting.

Timestamp support

Timestamps provide information on the timing of event generation with respect to their visibility at a trace output port. The timestamp counter size and clock frequency are IMPLEMENTATION DEFINED.

C1.7.2 Register support for the ITM

For register details see the appropriate ARM core or device documentation.

C1.8 Data Watchpoint and Trace (DWT) support

The Data Watchpoint and Trace (DWT) component provides the following features:

- PC sampling.
- Comparators to support:
 - Watchpoints – enters debug state
 - Data tracing
 - Signalling for use with an external resource, for example an ETM
 - Cycle count matched PC sampling.
- Exception trace support.
- CPI calculation support.

C1.8.1 Theory of operation

Apart from exception tracing, DWT functionality is counter or comparator based. Exception tracing and counter control is provided by the DWT Control register (DWT_CTRL). Watchpoint and data trace support use a set of compare, mask and function registers (DWT_COMPx, DWT_MASKx, and DWT_FUNCTIONx).

DWT generated events result in one of three actions:

- Generation of a hardware event packet. Packets are generated and combined with software event and timestamp packets for transmission via a TPIU.
- A core halt – entry to debug state.
- Generation of a CMPMATCH{N} signal as a control input to an external debug resource.

Exception tracing is enabled using the EXCTRCENA bit in the DWT_CTRL register. When the bit is set, the DWT emits an exception trace packet under the following conditions:

- Exception entry (from Thread mode or pre-emption of thread or handler).
- Exception exit when exiting a handler with an EXC_RETURN vector.
- Exception return when re-entering a pre-empted thread or handler code sequence.

C1.8.2 Register support for the DWT

For register details see the appropriate ARM core or device documentation.

C1.9 Embedded Trace (ETM) support

ETM is an optional feature in ARMv7-M. Where it is supported, a TPIU port must be provided which is capable of formatting an output packet stream from the ETM and DWT/ITM packet sources.

See the appropriate ARM core or device documentation for ETM support details.

C1.10 Trace Port Interface Unit (TPIU)

Hardware events from the DWT block and software events from the ITM block are multiplexed with time-stamp information into a packet stream. Control and Configuration of the timestamp information and the packet stream is part of the DWT and ITM blocks. It is IMPLEMENTATION DEFINED whether the packets are made visible to a debugger, either via a TPIU, Embedded Trace Buffer, or other means.

Direct visibility requires an implementation to provide a Trace Port Interface Unit (TPIU). For ARMv7-M this can be an asynchronous Serial Wire Output (SWO) or a synchronous (multi-wire) trace port. The combination of the DWT/ITM packet stream and a SWO is known as a Serial Wire Viewer (SWV).

The minimum TPIU support for ARMv7-M provides an output path for a DWT/ITM generated packet stream of hardware and/or software generated event information. This is known as TPIU support for debug trace with the TPIU operating in pass-through mode.

See the appropriate ARM core or device documentation for TPIU support details.

C1.11 Flash Patch and Breakpoint (FPB) support

The Flash Patch and Breakpoint (FPB) component provides support for remapping of specific instruction or literal locations from the Code region of system memory to an address in the SRAM region. See Table B2-1 on page B2-3 for information on address regions. For instruction fetches, the comparison can alternatively be configured to act as a BKPT instruction instead of remapping it.

———— **Note** ————

The FPB is not restricted to debug use only. The FPB can be used to support product updates, as it behaves the same under normal code execution conditions.

C1.11.1 Theory of operation

There are three types of register:

- A general control register FP_CTRL.
- A Remap address register FP_REMAP.
- FlashPatch comparator registers.

Separate comparators are used for instruction comparison and literal comparison. The number of each is IMPLEMENTATION DEFINED, and can be read from the FP_CTRL register.

The instruction-matching FlashPatch Comparator registers can be configured to remap the instruction or execute as a BKPT instruction.

The literal-matching comparators have fixed functionality, only supporting the remapping feature on data read accesses. Literal matching on reads can be on a word, halfword or byte quantum of data. Matches will fetch the appropriate data from the remapped location.

Each comparator has its own enable bit which comes into effect when the global enable bit is set.

C1.11.2 Register support for the FPB

For register details see the appropriate ARM core or device documentation.

Appendix A

Pseudo-code definition

This appendix provides a formal definition of the pseudo-code used in this book, and lists the *helper* procedures and functions used by pseudo-code to perform useful architecture-specific jobs. It contains the following sections:

- *Instruction encoding diagrams and pseudo-code* on page AppxA-2
- *Data Types* on page AppxA-4
- *Expressions* on page AppxA-8
- *Operators and built-in functions* on page AppxA-10
- *Statements and program structure* on page AppxA-18
- *Helper procedures and functions* on page AppxA-22.

AppxA.1 Instruction encoding diagrams and pseudo-code

Instruction descriptions in this book contain:

- An Encoding section, containing one or more encoding diagrams, each followed by some encoding-specific pseudo-code that translates the fields of the encoding into inputs for the common pseudo-code of the instruction, and picks out any encoding-specific special cases.
- An Operation section, containing common pseudo-code that applies to all of the encodings being described. The Operation section pseudo-code contains a call to the `EncodingSpecificOperations()` function, either at its start or after only a condition check performed by `if ConditionPassed() then`.

An encoding diagram specifies each bit of the instruction as one of the following:

- An obligatory 0 or 1, represented in the diagram as 0 or 1. If this bit does not have this value, the encoding corresponds to a different instruction.
- A *should be* 0 or 1, represented in the diagram as (0) or (1). If this bit does not have this value, the instruction is UNPREDICTABLE.
- A named single bit or a bit within a named multi-bit field.

An encoding diagram matches an instruction if all obligatory bits are identical in the encoding diagram and the instruction.

The execution model for an instruction is:

1. Find all encoding diagrams that match the instruction. It is possible that no encoding diagrams match. In that case, abandon this execution model and consult the relevant instruction set chapter instead to find out how the instruction is to be treated. (The bit pattern of such an instruction is usually reserved and UNDEFINED, though there are some other possibilities. For example, unallocated hint instructions are documented as being reserved and to be executed as NOPs.)
2. If the common pseudo-code for the matching encoding diagrams starts with a condition check, perform that condition check. If the condition check fails, abandon this execution model and treat the instruction as a NOP. (If there are multiple matching encoding diagrams, either all or none of their corresponding pieces of common pseudo-code start with a condition check.)
3. Perform the encoding-specific pseudo-code for each of the matching encoding diagrams independently and in parallel. Each such piece of encoding-specific pseudo-code starts with a bitstring variable for each named bit or multi-bit field within its corresponding encoding diagram, named the same as the bit or multi-bit field and initialized with the values of the corresponding bit(s) from the bit pattern of the instruction.

If there are multiple matching encoding diagrams, all but one of the corresponding pieces of pseudo-code must contain a special case that indicates that it does not apply. Discard the results of all such pieces of pseudo-code and their corresponding encoding diagrams.

There is now one remaining piece of pseudo-code and its corresponding encoding diagram left to consider. This pseudo-code might also contain a special case (most commonly one indicating that it is UNPREDICTABLE). If so, abandon this execution model and treat the instruction according to the special case.

4. Check the *should be* bits of the encoding diagram against the corresponding bits of the bit pattern of the instruction. If any of them do not match, abandon this execution model and treat the instruction as UNPREDICTABLE.
5. Perform the rest of the common pseudo-code for the instruction description that contains the encoding diagram. That pseudo-code starts with all variables set to the values they were left with by the encoding-specific pseudo-code.

The `ConditionPassed()` call in the common pseudo-code (if present) performs step 2, and the `EncodingSpecificOperations()` call performs steps 3 and 4.

AppxA.1.1 Pseudo-code

The pseudo-code provides precise descriptions of what instructions do. Instruction fields are referred to by the names shown in the encoding diagram for the instruction.

The pseudo-code is described in detail in the following sections.

AppxA.2 Data Types

This section describes:

- *General data type rules*
- *Bitstrings*
- *Integers* on page AppxA-5
- *Reals* on page AppxA-5
- *Booleans* on page AppxA-5
- *Enumerations* on page AppxA-5
- *Lists* on page AppxA-6
- *Arrays* on page AppxA-7.

AppxA.2.1 General data type rules

ARM Architecture pseudo-code is a strongly-typed language. Every constant and variable is of one of the following types:

- `bitstring`
- `integer`
- `boolean`
- `real`
- `enumeration`
- `list`
- `array`.

The type of a constant is determined by its syntax. The type of a variable is normally determined by assignment to the variable, with the variable being implicitly declared to be of the same type as whatever is assigned to it. For example, the assignments `x = 1`, `y = '1'`, and `z = TRUE` implicitly declare the variables `x`, `y` and `z` to have types `integer`, `length-1 bitstring` and `boolean` respectively.

Variables can also have their types declared explicitly by preceding the variable name with the name of the type. This is most often done in function definitions for the arguments and the result of the function.

These data types are described in more detail in the following sections.

AppxA.2.2 Bitstrings

A bitstring is a finite-length string of 0s and 1s. Each length of bitstring is a different type. The minimum allowed length of a bitstring is 1.

The type name for bitstrings of length `N` is `bits(N)`. A synonym of `bits(1)` is `bit`.

Bitstring constants are written as a single quotation mark, followed by the string of 0s and 1s, followed by another single quotation mark. For example, the two constants of type `bit` are `'0'` and `'1'`.

Every bitstring value has a left-to-right order, with the bits being numbered in standard *little-endian* order. That is, the leftmost bit of a bitstring of length N is bit $N-1$ and its rightmost bit is bit 0 . This order is used as the most-significant-to-least-significant bit order in conversions to and from integers. For bitstring constants and bitstrings derived from encoding diagrams, this order matches the way they are printed.

Bitstrings are the only concrete data type in pseudo-code, in the sense that they correspond directly to the contents of registers, memory locations, instructions, and so on. All of the remaining data types are abstract.

AppxA.2.3Integers

Pseudo-code integers are unbounded in size and can be either positive or negative. That is, they are mathematical integers rather than what computer languages and architectures commonly call integers. Computer integers are represented in pseudo-code as bitstrings of the appropriate length, associated with suitable functions to interpret those bitstrings as integers.

The type name for integers is `integer`.

Integer constants are normally written in decimal, such as `0`, `15`, `-1234`. They can also be written in C-style hexadecimal, such as `0x55` or `0x80000000`. Hexadecimal integer constants are treated as positive unless they have a preceding minus sign. For example, `0x80000000` is the integer $+2^{31}$. If -2^{31} needs to be written in hexadecimal, it should be written as `-0x80000000`.

AppxA.2.4Reals

Pseudo-code reals are unbounded in size and precision. That is, they are mathematical real numbers, not computer floating-point numbers. Computer floating-point numbers are represented in pseudo-code as bitstrings of the appropriate length, associated with suitable functions to interpret those bitstrings as reals.

The type name for reals is `real`.

Real constants are written in decimal with a decimal point (so `0` is an integer constant, but `0.0` is a real constant).

AppxA.2.5Booleans

A boolean is a logical true or false value.

The type name for booleans is `boolean`. This is not the same type as `bit`, which is a length-1 bitstring.

Boolean constants are `TRUE` and `FALSE`.

AppxA.2.6Enumerations

An enumeration is a defined set of symbolic constants, such as:

```
enumeration SRType (SRType_None, SRType_LSL, SRType_LSR,
                    SRType_ASR, SRType_ROR, SRType_RRX);
```

An enumeration always contains at least one symbolic constant, and symbolic constants are not allowed to be shared between enumerations.

Enumerations must be declared explicitly, though a variable of an enumeration type can be declared implicitly as usual by assigning one of the symbolic constants to it. By convention, each of the symbolic constants starts with the name of the enumeration followed by an underscore. The name of the enumeration is its type name, and the symbolic constants are its possible constants.

———— **Note** —————

Booleans are basically a pre-declared enumeration:

```
enumeration boolean {FALSE, TRUE};
```

that does not follow the normal naming convention and that has a special role in some pseudo-code constructs, such as `if` statements.

AppxA.2.7Lists

A list is an ordered set of other data items, separated by commas and enclosed in parentheses, such as:

```
(bits(32) shifter_result, bit shifter_carry_out)
```

A list always contains at least one data item.

Lists are often used as the return type for a function that returns multiple results. For example, this particular list is the return type of the function `Shift_C()` that performs a standard ARM shift or rotation, when its first operand is of type `bits(32)`.

Some specific pseudo-code operators use lists surrounded by other forms of bracketing than parentheses. These are:

- Bitstring extraction operators, which use lists of bit numbers or ranges of bit numbers surrounded by angle brackets "`<...>`".
- Array indexing, which uses lists of array indexes surrounded by square brackets "`[...]`".
- Array-like function argument passing, which uses lists of function arguments surrounded by square brackets "`[...]`".

Each combination of data types in a list is a separate type, with type name given by just listing the data types (that is, `(bits(32), bit)` in the above example). The general principle that types can be declared by assignment extends to the types of the individual list items within a list. For example:

```
(shift_t, shift_n) = ('00', 0);
```

implicitly declares `shift_t`, `shift_n` and `(shift_t, shift_n)` to be of types `bits(2)`, `integer` and `(bits(2), integer)` respectively.

A list type can also be explicitly named, with explicitly named elements in the list. For example:

```
type ShiftSpec is (bits(2) shift, integer amount);
```

After this definition and the declaration:

```
ShiftSpec abc;
```

the elements of the resulting list can then be referred to as "abc.shift" and "abc.amount". This sort of qualified naming of list elements is only permitted for variables that have been explicitly declared, not for those that have been declared by assignment only.

Explicitly naming a type does not alter what type it is. For example, after the above definition of ShiftSpec, ShiftSpec and (bits(2), integer) are two different names for the same type, not the names of two different types. In order to avoid ambiguity in references to list elements, it is an error to declare a list variable multiple times using different names of its type or to qualify it with list element names not associated with the name by which it was declared.

An item in a list that is being assigned to may be written as "-" to indicate that the corresponding item of the assigned list value is discarded. For example:

```
(shifted, -) = LSL_C(operand, amount);
```

List constants are written as a list of constants of the appropriate types, like ('00', 0) in the above example.

AppxA.2.8 Arrays

Pseudo-code arrays are indexed by either enumerations or integer ranges (represented by the lower inclusive end of the range, then "..", then the upper inclusive end of the range). For example:

```
enumeration PhysReg {
    PhysReg_R0,    PhysReg_R1,    PhysReg_R2,    PhysReg_R3,
    PhysReg_R4,    PhysReg_R5,    PhysReg_R6,    PhysReg_R7,
    PhysReg_R8,    PhysReg_R9,    PhysReg_R10,   PhysReg_R11,
    PhysReg_R12,   PhysReg_SP_Process,   PhysReg_SP_Main,
    PhysReg_LR,    PhysReg_PC};
```

```
array bits(32) _R[PhysReg];
```

```
array bits(8) _Memory[0..0xFFFFFFFF];
```

Arrays are always explicitly declared, and there is no notation for a constant array. Arrays always contain at least one element, because enumerations always contain at least one symbolic constant and integer ranges always contain at least one integer.

Arrays do not usually appear directly in pseudo-code. The items that syntactically look like arrays in pseudo-code are usually array-like functions such as R[i], MemU[address, size] or Element[i, type]. These functions package up and abstract additional operations normally performed on accesses to the underlying arrays, such as register banking, memory protection, endian-dependent byte ordering, exclusive-access housekeeping and vector element processing.

AppxA.3 Expressions

This section describes:

- *General expression syntax*
- *Operators and functions - polymorphism and prototypes* on page AppxA-9
- *Precedence rules* on page AppxA-9.

AppxA.3.1 General expression syntax

An expression is one of the following:

- a constant
- a variable, optionally preceded by a data type name to declare its type
- the word UNKNOWN preceded by a data type name to declare its type
- the result of applying a language-defined operator to other expressions
- the result of applying a function to other expressions.

An expression like "bits(32) UNKNOWN" indicates that the result of the expression is a value of the given type, but the architecture does not specify what value it is and software must not rely on such values. The value produced must not constitute a security hole and must not be promoted as providing any useful information to software. (This was called an UNPREDICTABLE value in previous ARM Architecture documentation. It is related to but not the same as UNPREDICTABLE, which says that the entire architectural state becomes similarly unspecified.)

A subset of expressions are assignable. That is, they can be placed on the left-hand side of an assignment. This subset consists of:

- Variables
- The results of applying some operators to other expressions. The description of each language-defined operator that can generate an assignable expression specifies the circumstances under which it does so. (For example, those circumstances might include one or more of the expressions the operator operates on themselves being assignable expressions.)
- The results of applying array-like functions to other expressions. The description of an array-like function specifies the circumstances under which it can generate an assignable expression.

Every expression has a data type. This is determined by:

- For a constant, the syntax of the constant.
- For a variable, there are three possible sources for the type
 - its optional preceding data type name
 - a data type it was given earlier in the pseudo-code by recursive application of this rule
 - a data type it is being given by assignment (either by direct assignment to it, or by assignment to a list of which it is a member).

It is a pseudo-code error if none of these data type sources exists for a variable, or if more than one of them exists and they do not agree about the type.

- For a language-defined operator, the definition of the operator.
- For a function, the definition of the function.

AppxA.3.2 Operators and functions - polymorphism and prototypes

Operators and functions in pseudo-code can be polymorphic, producing different functionality when applied to different data types. Each of the resulting forms of an operator or function has a different prototype definition. For example, the operator + has forms that act on various combinations of integers, reals and bitstrings.

One particularly common form of polymorphism is between bitstrings of different lengths. This is represented by using `bits (N)`, `bits (M)`, and so on, in the prototype definition.

AppxA.3.3 Precedence rules

The precedence rules for expressions are:

1. Constants, variables and function invocations are evaluated with higher priority than any operators using their results.
2. Expressions on integers follow the normal *exponentiation before multiply/divide before add/subtract* operator precedence rules, with sequences of multiply/divides or add/subtracts evaluated left-to-right.
3. Other expressions must be parenthesized to indicate operator precedence if ambiguity is possible, but need not be if all allowable precedence orders under the type rules necessarily lead to the same result. For example, if `i`, `j` and `k` are integer variables, `i > 0 && j > 0 && k > 0` is acceptable, but `i > 0 && j > 0 || k > 0` is not.

AppxA.4 Operators and built-in functions

This section describes:

- *Operations on generic types*
- *Operations on booleans*
- *Bitstring manipulation*
- *Arithmetic* on page AppxA-14.

AppxA.4.1 Operations on generic types

The following operations are defined for all types.

Equality and non-equality testing

Any two values x and y of the same type can be tested for equality by the expression $x == y$ and for non-equality by the expression $x != y$. In both cases, the result is of type `boolean`.

Conditional selection

If x and y are two values of the same type and t is a value of type `boolean`, then `if t then x else y` is an expression of the same type as x and y that produces x if t is `TRUE` and y if t is `FALSE`.

AppxA.4.2 Operations on booleans

If x is a `boolean`, then `!x` is its logical inverse.

If x and y are booleans, then `x && y` is the result of ANDing them together. As in the C language, if x is `FALSE`, the result is determined to be `FALSE` without evaluating y .

If x and y are booleans, then `x || y` is the result of ORing them together. As in the C language, if x is `TRUE`, the result is determined to be `TRUE` without evaluating y .

If x and y are booleans, then `x ^ y` is the result of exclusive-ORing them together.

AppxA.4.3 Bitstring manipulation

The following bitstring manipulation functions are defined:

Bitstring length and top bit

If x is a bitstring, the bitstring length function `Len(x)` returns its length as an integer, and `TopBit(x)` is the leftmost bit of x ($= x < \text{Len}(x) - 1 >$) using bitstring extraction.

Bitstring concatenation and replication

If x and y are bitstrings of lengths N and M respectively, then $x:y$ is the bitstring of length $N+M$ constructed by concatenating x and y in left-to-right order.

If x is a bitstring and n is an integer with $n > 0$, $\text{Replicate}(x, n)$ is the bitstring of length $n \cdot \text{Len}(x)$ consisting of n copies of x concatenated together.

Bitstring extraction

The bitstring extraction operator extracts a bitstring from either another bitstring or an integer. Its syntax is $x\langle\text{integer_list}\rangle$, where x is the integer or bitstring being extracted from, and $\langle\text{integer_list}\rangle$ is a list of integers enclosed in angle brackets rather than the usual parentheses. The length of the resulting bitstring is equal to the number of integers in $\langle\text{integer_list}\rangle$.

In $x\langle\text{integer_list}\rangle$, each of the integers in $\langle\text{integer_list}\rangle$ must be:

- ≥ 0
- $< \text{Len}(x)$ if x is a bitstring.

The definition of $x\langle\text{integer_list}\rangle$ depends on whether integer_list contains more than one integer. If it does, $x\langle i, j, k, \dots, n \rangle$ is defined to be the concatenation:

$x\langle i \rangle : x\langle j \rangle : x\langle k \rangle : \dots : x\langle n \rangle$

If integer_list consists of just one integer i , $x\langle i \rangle$ is defined to be:

- if x is a bitstring, '0' if bit i of x is a zero and '1' if bit i of x is a one.
- if x is an integer, let y be the unique integer in the range 0 to $2^{(i+1)} - 1$ that is congruent to x modulo $2^{(i+1)}$. Then $x\langle i \rangle$ is '0' if $y < 2^i$ and '1' if $y \geq 2^i$.

Loosely, this second definition treats an integer as equivalent to a sufficiently long 2's complement representation of it as a bitstring.

In $\langle\text{integer_list}\rangle$, the notation $i:j$ with $i \geq j$ is shorthand for the integers in order from i down to j , both ends inclusive. For example, $\text{instr}\langle 31:28 \rangle$ is shorthand for $\text{instr}\langle 31, 30, 29, 28 \rangle$.

The expression $x\langle\text{integer_list}\rangle$ is assignable provided x is an assignable bitstring and no integer appears more than once in $\langle\text{integer_list}\rangle$. In particular, $x\langle i \rangle$ is assignable if x is an assignable bitstring and $0 \leq i < \text{Len}(x)$.

Logical operations on bitstrings

If x is a bitstring, $\text{NOT}(x)$ is the bitstring of the same length obtained by logically inverting every bit of x .

If x and y are bitstrings of the same length, $x \text{ AND } y$, $x \text{ OR } y$, and $x \text{ EOR } y$ are the bitstrings of that same length obtained by logically ANDing, ORing, and exclusive-ORing corresponding bits of x and y together.

Bitstring count

If x is a bitstring, `BitCount(x)` produces an integer result equal to the number of bits of x that are ones.

Testing a bitstring for being all zero

If x is a bitstring, `IsZero(x)` produces `TRUE` if all of the bits of x are zeros and `FALSE` if any of them are ones, and `IsZeroBit(x)` produces `'1'` if all of the bits of x are zeros and `'0'` if any of them are ones. So:

```
IsZero(x)      = (BitCount(x) == 0)
```

```
IsZeroBit(x) = if IsZero(x) then '1' else '0'
```

Lowest and highest set bits of a bitstring

If x is a bitstring:

- `LowestSetBit(x)` is the minimum bit number of any of its bits that are ones. If all of its bits are zeros, `LowestSetBit(x) = Len(x)`.
- `HighestSetBit(x)` is the maximum bit number of any of its bits that are ones. If all of its bits are zeros, `HighestSetBit(x) = -1`.

Zero-extension and sign-extension of bitstrings

If x is a bitstring and i is an integer, then `ZeroExtend(x, i)` is x extended to a length of i bits, by adding sufficient zero bits to its left. That is, if $i == Len(x)$, then `ZeroExtend(x, i) = x`, and if $i > Len(x)$, then:

```
ZeroExtend(x, i) = Replicate('0', i-Len(x)) : x
```

If x is a bitstring and i is an integer, then `SignExtend(x, i)` is x extended to a length of i bits, by adding sufficient copies of its leftmost bit to its left. That is, if $i == Len(x)$, then `SignExtend(x, i) = x`, and if $i > Len(x)$, then:

```
SignExtend(x, i) = Replicate(TopBit(x), i-Len(x)) : x
```

It is a pseudo-code error to use either `ZeroExtend(x, i)` or `SignExtend(x, i)` in a context where it is possible that $i < Len(x)$.

Shifting and rotating bitstrings

Functions are defined to perform logical shift left, logical shift right, arithmetic shift right, rotate left, rotate right and rotate right extended functions on bitstrings.

The first group of such functions are shifts producing a result bitstring of the same length as their bitstring operand and a carry out bit, as follows:

```
(bits(N), bit) LSL_C(bits(N) x, integer n)
  assert n > 0;
  extended_x = x : Replicate('0', n);
  result = extended_x<Len(x)-1:0>;
  c_out = extended_x<Len(x)>;
  return (result, c_out);
```

```
(bits(N), bit) LSR_C(bits(N) x, integer n)
  assert n > 0;
  extended_x = Replicate('0', n) : x;
  result = extended_x<n+Len(x)-1:n>;
  c_out = extended_x<n-1>;
  return (result, c_out);
```

```
(bits(N), bit) ASR_C(bits(N) x, integer n)
  assert n > 0;
  extended_x = Replicate(TopBit(x), n) : x;
  result = extended_x<n+Len(x)-1:n>;
  c_out = extended_x<n-1>;
  return (result, c_out);
```

Versions of these functions that do not produce the carry out bit are:

```
bits(N) LSL(bits(N) x, integer n)
  assert n >= 0;
  if n == 0 then
    result = x;
  else
    (result, -) = LSL_C(x, n);
  return result;
```

```
bits(N) LSR(bits(N) x, integer n)
  assert n >= 0;
  if n == 0 then
    result = x;
  else
    (result, -) = LSR_C(x, n);
  return result;
```

```
bits(N) ASR(bits(N) x, integer n)
  assert n >= 0;
  if n == 0 then
    result = x;
  else
    (result, -) = ASR_C(x, n);
  return result;
```

The corresponding rotation functions are then defined by:

```
(bits(N), bit) ROR_C(bits(N) x, integer n)
  m = n DIV Len(x);
  result = if m == 0 then x else LSR(x,m) OR LSL(x,Len(x)-m);
  c_out = result<Len(x)-1>;
```

```

    return (result, c_out);

(bits(N), bit) ROL_C(bits(N) x, integer n)
    m = n DIV Len(x);
    result = if m == 0 then x else LSL(x,m) OR LSR(x,Len(x)-m);
    c_out = result<0>;
    return (result, c_out);

(bits(N), bit) RRX_C(bits(N) x, bit c_in)
    result = c_in : x<Len(x)-1:1>;
    c_out = x<0>;
    return (result, c_out);

bits(N) ROR(bits(N) x, integer n)
    (result, -) = ROR_C(x, n);
    return result;

bits(N) ROL(bits(N) x, integer n)
    (result, -) = ROL_C(x, n);
    return result;

bits(N) RRX(bits(N) x, bit c_in)
    (result, -) = RRX_C(x, c_in);
    return result;

```

Converting bitstrings to integers

If x is a bitstring, $SInt(x)$ is the integer whose 2's complement representation is x :

```

integer SInt(bits(N) x)
    integer result = 0;
    for i = 0 to Len(x)-1
        if x<i> == '1' then result = result + 2^i;
    if x<Len(x)-1> == '1' then result = result - 2^Len(x);
    return result;

```

$UInt(x)$ is the integer whose unsigned representation is x :

```

integer SInt(bits(N) x)
    integer result = 0;
    for i = 0 to Len(x)-1
        if x<i> == '1' then result = result + 2^i;
    return result;

```

AppxA.4.4 Arithmetic

Most pseudo-code arithmetic is performed on integer or real values, with operands being obtained by conversions from bitstrings and results converted back to bitstrings afterwards. As these data types are the unbounded mathematical types, no issues arise about overflow or similar errors.

Unary plus, minus and absolute value

If x is an integer or real, then $+x$ is x unchanged, $-x$ is x with its sign reversed, and $ABS(x)$ is the absolute value of x . All three are of the same type as x .

Addition and subtraction

If x and y are integers or reals, $x+y$ and $x-y$ are their sum and difference. Both are of type `integer` if x and y are both of type `integer`, and `real` otherwise.

Addition and subtraction are particularly common arithmetic operations in pseudo-code, and so it is also convenient to have definitions of addition and subtraction acting directly on bitstring operands.

If x and y are bitstrings of the same length $N = \text{Len}(x) = \text{Len}(y)$, then $x+y$ and $x-y$ are the least significant N bits of the results of converting them to integers and adding or subtracting them. Signed and unsigned conversions produce the same result:

$$\begin{aligned} x+y &= (\text{SInt}(x) + \text{SInt}(y))\langle N-1:0 \rangle \\ &= (\text{UInt}(x) + \text{UInt}(y))\langle N-1:0 \rangle \end{aligned}$$

$$\begin{aligned} x-y &= (\text{SInt}(x) - \text{SInt}(y))\langle N-1:0 \rangle \\ &= (\text{UInt}(x) - \text{UInt}(y))\langle N-1:0 \rangle \end{aligned}$$

If x is a bitstring of length N and y is an integer, $x+y$ and $x-y$ are the bitstrings of length N defined by $x+y = x + y\langle N-1:0 \rangle$ and $x-y = x - y\langle N-1:0 \rangle$. Similarly, if x is an integer and y is a bitstring of length M , $x+y$ and $x-y$ are the bitstrings of length M defined by $x+y = x\langle M-1:0 \rangle + y$ and $x-y = x\langle M-1:0 \rangle - y$.

A function `AddWithCarry()` is also defined that returns unsigned carry and signed overflow information as well as the result of a bitstring addition of two equal-length bitstrings and a carry-in bit:

```
(bits(N), bit, bit) AddWithCarry(bits(N) x, bits(N) y, bit carry_in)
    unsigned_sum = UInt(x) + UInt(y) + UInt(carry_in);
    signed_sum   = SInt(x) + SInt(y) + UInt(carry_in);
    result       = unsigned_sum<N-1:0>; // = signed_sum<N-1:0>
    carry_out    = if UInt(result) == unsigned_sum then '0' else '1';
    overflow     = if SInt(result) == signed_sum then '0' else '1';
    return (result, carry_out, overflow);
```

An important property of the `AddWithCarry()` function is that if:

```
(result, carry_out, overflow) = AddWithCarry(x, NOT(y), carry_in)
```

then:

- If `carry_in == '1'`, then `result == x-y` with `overflow == '1'` if signed overflow occurred during the subtraction and `carry_out == '1'` if unsigned borrow did not occur during the subtraction (that is, if $x \geq y$).
- If `carry_in == '0'`, then `result == x-y-1` with `overflow == '1'` if signed overflow occurred during the subtraction and `carry_out = '1'` if unsigned borrow did not occur during the subtraction (that is, if $x > y$).

Together, these mean that the `carry_in` and `carry_out` bits in `AddWithCarry()` calls can act as *NOT borrow* flags for subtractions as well as *carry* flags for additions. This is used extensively in the definitions of the main addition/subtraction instructions.

Comparisons

If x and y are integers or reals, then $x == y$, $x != y$, $x < y$, $x <= y$, $x > y$, and $x >= y$ are equal, not equal, less than, less than or equal, greater than, and greater than or equal comparisons between them, producing boolean results. In the case of `==` and `!=`, this extends the generic definition applying to any two values of the same type to also act between integers and reals.

Multiplication

If x and y are integers or reals, then $x * y$ is the product of x and y , of type `integer` if both x and y are of type `integer` and otherwise of type `real`.

Division and modulo

If x and y are integers or reals, then x / y is the result of dividing x by y , and is always of type `real`.

If x and y are integers, then $x \text{ DIV } y$ and $x \text{ MOD } y$ are defined by:

$$x \text{ DIV } y = \text{RoundDown}(x / y)$$

$$x \text{ MOD } y = x - y * (x \text{ DIV } y)$$

It is a pseudo-code error to use any x / y , $x \text{ MOD } y$, or $x \text{ DIV } y$ in any context where y can be zero.

Rounding and aligning

If x is a real:

- `RoundDown(x)` produces the largest integer n such that $n \leq x$.
- `RoundUp(x)` produces the smallest integer n such that $n \geq x$.
- `RoundTowardsZero(x)` produces `RoundDown(x)` if $x > 0.0$, `0` if $x == 0.0$, and `RoundUp(x)` if $x < 0.0$.

If x and y are integers, `Align(x,y) = y * (x DIV y)` is an integer.

If x is a bitstring and y is an integer, `Align(x,y) = (Align(UInt(x),y)) <Len(x)-1:0>` is a bitstring of the same length as x .

It is a pseudo-code error to use either form of `Align(x,y)` in any context where y can be 0. In practice, `Align(x,y)` is only used with y a constant power of two, and the bitstring form used with $y = 2^n$ has the effect of producing its argument with its n low-order bits forced to zero.

Scaling

If n is an integer, 2^n is the result of raising 2 to the power n and is of type `real`.

If x and n are integers, then:

- $x \ll n = \text{RoundDown}(x * 2^n)$
- $x \gg n = \text{RoundDown}(x * 2^{(-n)})$.

Maximum and minimum

If x and y are integers or reals, then $\text{Max}(x, y)$ and $\text{Min}(x, y)$ are their maximum and minimum respectively. Both are of type `integer` if both x and y are of type `integer` and of type `real` otherwise.

Saturation

If i and j are integers with $j > 0$, $\text{SignedSatQ}(i, j)$ produces the j -bit 2's complement representation of the result of saturating i to the j -bit signed range together with a boolean that indicates whether saturation occurred:

```
(bits(j), boolean) SignedSatQ(integer i, integer j)
    assert j > 0;
    saturated_i = Min(Max(i, -(2^(j-1))), (2^(j-1))-1);
    result      = saturated_i<j-1:0>;
    sat        = (result != i);           // (i < -(2^(j-1))) || (i >= 2^(j-1))
    return (result, sat);
```

$\text{UnsignedSatQ}(i, j)$ performs the corresponding unsigned saturation:

```
(bits(j), boolean) UnsignedSatQ(integer i, integer j)
    assert j > 0;
    saturated_i = Min(Max(i, 0), (2^j)-1);
    result      = saturated_i<j-1:0>;
    sat        = (result != i);           // (i < 0) || (i >= 2^j)
    return (result, sat);
```

$\text{SignedSat}(i, j)$ and $\text{UnsignedSat}(i, j)$ produce the equivalent operations without the boolean result:

```
bits(j) SignedSat(integer i, integer j)
    (result, -) = SignedSatQ(i, j);
    return result;

bits(j) UnsignedSat(integer i, integer j)
    (result, -) = UnsignedSatQ(i, j);
    return result;
```

AppxA.5 Statements and program structure

This section describes the control statements used in the pseudo-code.

AppxA.5.1 Simple statements

The following simple statements must all be terminated with a semicolon, as shown.

Assignments

An assignment statement takes the form:

```
<assignable_expression> = <expression>;
```

Procedure calls

A procedure call takes the form:

```
<procedure_name> (<arguments>;
```

Return statements

A procedure return takes the form:

```
return;
```

and a function return takes the form:

```
return <expression>;
```

where <expression> is of the type the function prototype line declared.

UNDEFINED

The statement:

```
UNDEFINED;
```

indicates a special case that replaces the behavior defined by the current pseudo-code (apart from behavior required to determine that the special case applies). The replacement behavior is that the Undefined Instruction exception is taken.

UNPREDICTABLE

The statement:

```
UNPREDICTABLE;
```

indicates a special case that replaces the behavior defined by the current pseudo-code (apart from behavior required to determine that the special case applies). The replacement behavior is not architecturally defined and must not be relied upon by software. It must not constitute a security hole or halt or hang the system, and must not be promoted as providing any useful information to software.

SEE...

The statement:

```
SEE <reference>;
```

indicates a special case that replaces the behavior defined by the current pseudo-code (apart from behavior required to determine that the special case applies). The replacement behavior is that nothing occurs as a result of the current pseudo-code because some other piece of pseudo-code defines the required behavior. The <reference> indicates where that other pseudo-code can be found.

AppxA.5.2 Compound statements

Indentation is normally used to indicate structure in compound statements. The statements contained in structures such as `if ... then ... else ...` or procedure and function definitions are indented more deeply than the statement itself, and their end is indicated by returning to the original indentation level or less.

Indentation is normally done by four spaces for each level.

if ... then ... else ...

A multi-line `if ... then ... else ...` structure takes the form:

```
if <boolean_expression> then
    <statement 1>
    <statement 2>
    ...
    <statement n>
else
    <statement A>
    <statement B>
    ...
    <statement Z>
```

The `else` and its following statements are optional.

Abbreviated one-line forms can be used when there is just one simple statement in the `then` part and (if present) the `else` part, as follows:

```
if <boolean_expression> then <statement 1>
```

```
if <boolean_expression> then <statement 1> else <statement A>
```

Note

In these forms, <statement 1> and <statement A> are necessarily terminated by semicolons. This and the fact that the else part is optional are differences from the if ... then ... else ... expression.

repeat ... until ...

A repeat ... until ... structure takes the form:

```
repeat
    <statement 1>
    <statement 2>
    ...
    <statement n>
until <boolean_expression>;
```

for ...

A for ... structure takes the form:

```
for <assignable_expression> = <integer_expr1> to <integer_expr2>
    <statement 1>
    <statement 2>
    ...
    <statement n>
```

case ... of ...

A case ... of ... structure takes the form:

```
case <expression> of
    when <constant values>
        <statement 1>
        <statement 2>
        ...
        <statement n>
    ... more "when" groups ...
    otherwise
        <statement A>
        <statement B>
        ...
        <statement Z>
```

where <constant values> consists of one or more constant values of the same type as <expression>, separated by commas.

Procedure and function definitions

A procedure definition takes the form:

```
<procedure name>(<argument prototypes>)
  <statement 1>
  <statement 2>
  ...
  <statement n>
```

where the <argument prototypes> consists of zero or more argument definitions, separated by commas. Each argument definition consists of a type name followed by the name of the argument.

———— **Note** —————

This first prototype line is not terminated by a semicolon. This helps to distinguish it from a procedure call.

A function definition is similar, but also declares the return type of the function:

```
<return type> <function name>(<argument prototypes>)
  <statement 1>
  <statement 2>
  ...
  <statement n>
```

AppxA.5.3Comments

Two styles of pseudo-code comment exist:

- // starts a comment that is terminated by the end of the line.
- /* starts a comment that is terminated by */.

AppxA.6 Helper procedures and functions

The functions described in this section are not part of the pseudo-code specification. They are *helper* procedures and functions used by pseudo-code to perform useful architecture-specific jobs. Each has a brief description and a pseudo-code prototype. Some have had a pseudo-code definition added.

AppxA.6.1 ALUWritePC()

This procedure writes a value to the PC with the correct semantics for such a write by the `ADD (register)` and `MOV (register)` data-processing instructions.

```
ALUWritePC(bits(32) value)
```

AppxA.6.2 ArchVersion()

This function returns the major version number of the architecture.

```
integer ArchVersion()
```

AppxA.6.3 BadReg()

This function performs the check for the register numbers 13 and 15 that are disallowed for many Thumb register specifiers.

```
boolean BadReg(integer n)  
return n == 13 || n == 15;
```

AppxA.6.4 BigEndian()

This function returns `TRUE` if load/store operations are currently big-endian, and `FALSE` if they are little-endian.

```
boolean BigEndian()
```

AppxA.6.5 BranchWritePC()

This procedure writes a value to the PC with the correct semantics for such writes by simple branches - that is, just a change to the PC in all circumstances.

```
BranchWritePC(bits(32) value)
```

AppxA.6.6 BreakPoint()

This procedure causes a debug breakpoint to occur.

AppxA.6.7BXWritePC()

This procedure writes a value to the PC with the correct semantics for such writes by interworking instructions. That is, with BX-like interworking behavior in all circumstances.

```
BXWritePC(bits(32) value)
```

———— **Note** —————

The M profile only supports the Thumb execution state. An attempt to change the instruction execution state causes an exception.

AppxA.6.8CallSupervisor()

In the M profile, this procedure causes an SVCAll exception.

AppxA.6.9ClearEventRegister()

This procedure clears the event register on the current processor. See *EventRegistered()* on page AppxA-25 for details of the event register.

AppxA.6.10ClearExclusiveMonitors()

This procedure clears the monitors used by the load/store exclusive instructions.

AppxA.6.11ConditionPassed()

This function performs the condition test for an instruction, based on:

- the two Thumb conditional branch encodings (encodings T1 and T3 of the B instruction)
- the current values of the xPSR.IT[7:0] bits for other Thumb instructions.

```
boolean ConditionPassed()
```

AppxA.6.12Coproc_Accepted()

This function determines whether a coprocessor accepts an instruction.

```
boolean Coproc_Accepted(integer cp_num, bits(32) instr)
```

AppxA.6.13Coproc_DoneLoading()

This function determines for an LDC instruction whether enough words have been loaded.

```
boolean Coproc_DoneLoading(integer cp_num, bits(32) instr)
```

AppxA.6.14Cproc_DoneStoring()

This function determines for an STC instruction whether enough words have been stored.

```
boolean Cproc_DoneStoring(integer cp_num, bits(32) instr)
```

AppxA.6.15Cproc_GetOneWord()

This function obtains the word for an MRC instruction from the coprocessor.

```
bits(32) Cproc_GetOneWord(integer cp_num, bits(32) instr)
```

AppxA.6.16Cproc_GetTwoWords()

This function obtains the two words for an MRRC instruction from the coprocessor.

```
(bits(32), bits(32)) Cproc_GetTwoWords(integer cp_num, bits(32) instr)
```

AppxA.6.17Cproc_GetWordToStore()

This function obtains the next word to store for an STC instruction from the coprocessor

```
bits(32) Cproc_GetWordToStore(integer cp_num, bits(32) instr)
```

AppxA.6.18Cproc_InternalOperation()

This procedure instructs a coprocessor to perform the internal operation requested by a CDP instruction.

```
Cproc_InternalOperation(integer cp_num, bits(32) instr)
```

AppxA.6.19Cproc_SendLoadedWord()

This procedure sends a loaded word for an LDC instruction to the coprocessor.

```
Cproc_SendLoadedWord(bits(32) word, integer cp_num, bits(32) instr)
```

AppxA.6.20Cproc_SendOneWord()

This procedure sends the word for an MCR instruction to the coprocessor.

```
Cproc_SendOneWord(bits(32) word, integer cp_num, bits(32) instr)
```

AppxA.6.21Cproc_SendTwoWords()

This procedure sends the two words for an MCRR instruction to the coprocessor.

```
Cproc_SendTwoWords(bits(32) word1, bits(32) word2, integer cp_num,  
bits(32) instr)
```

AppxA.6.22DataMemoryBarrier()

This procedure produces a Data Memory Barrier.

`DataMemoryBarrier(bits(4) option)`

AppxA.6.23DataSynchronizationBarrier()

This procedure produces a Data Synchronization Barrier.

`DataSynchronizationBarrier(bits(4) option)`

AppxA.6.24DecodeImmShift(), DecodeRegShift()

These functions perform the standard *2-bit type*, *5-bit amount* and *2-bit type* decodes for immediate and register shifts respectively. See *Shift operations* on page A5-11.

AppxA.6.25EventRegistered()

This function returns TRUE if the event register on the current processor is set and FALSE if it is clear. The event register is set as a result of any of the following events:

- an IRQ interrupt, unless masked by the CPSR I-bit
- an FIQ interrupt, unless masked by the CPSR F-bit
- an Imprecise Data abort, unless masked by the CPSR A-bit
- a Debug Entry request, if Debug is enabled
- an event sent by any processor in the multi-processor system as a result of that processor executing a `Hint_SendEvent()`
- an exception return
- implementation-specific reasons, that might be IMPLEMENTATION DEFINED but also might occur arbitrarily.

The state of the event register is UNKNOWN at Reset.

AppxA.6.26EncodingSpecificOperations()

This procedure invokes the encoding-specific pseudo-code for an instruction encoding and checks the 'should be' bits of the encoding, as described in *Instruction encoding diagrams and pseudo-code* on page AppxA-2.

AppxA.6.27ExclusiveMonitorsPass()

This function determines whether a store exclusive instruction is successful. A store exclusive is successful if it still has possession of the exclusive monitors.

```
boolean ExclusiveMonitorsPass(bits(32) address, integer size)
```

AppxA.6.28Hint_Debug()

This procedure supplies a hint to the debug system.

```
Hint_Debug(bits(4) option)
```

AppxA.6.29Hint_PreloadData()

This procedure performs a *preload data* hint.

```
Hint_PreloadData(bits(32) address)
```

AppxA.6.30Hint_PreloadInstr()

This procedure performs a *preload instructions* hint.

```
Hint_PreloadInstr(bits(32) address)
```

AppxA.6.31Hint_SendEvent()

This procedure performs a *send event* hint.

AppxA.6.32Hint_Yield()

This procedure performs a *Yield* hint.

AppxA.6.33InITBlock()

This function returns TRUE if execution is currently in an IT block and FALSE otherwise.

```
boolean InITBlock()
```

AppxA.6.34InstructionSynchronizationBarrier()

This procedure produces an Instruction Synchronization Barrier.

```
InstructionSynchronizationBarrier(bits(4) option)
```

AppxA.6.35IntegerZeroDivideTrappingEnabled()

This function returns TRUE if the trapping of divisions by zero in the integer division instructions SDIV and UDIV is enabled, and FALSE otherwise.

In the M profile, this is controlled by the DIV_0_TRP bit in the Configuration Control register. TRUE is returned if the bit is 1 and FALSE if it is 0.

AppxA.6.36LastInITBlock()

This function returns TRUE if the current instruction is the last instruction in an IT block, and FALSE otherwise.

AppxA.6.37LoadWritePC()

This procedure writes a value to the PC with BX-like interworking behavior for writes by load instructions..

```
LoadWritePC(bits(32) value)
```

———— **Note** —————

The M profile only supports the Thumb execution state. An attempt to change the instruction execution state causes an exception.

—————

AppxA.6.38MemA[]

This array-like function performs a memory access that is required to be aligned, using the current privilege level.

```
bits(8*size) MemA[bits(32) address, integer size]
MemA[bits(32) address, integer size] = bits(8*size) value
```

AppxA.6.39MemAA[]

This array-like function performs a memory access that is required to be aligned and atomic, using the current privilege level.

```
bits(8*size) MemAA[bits(32) address, integer size]
MemAA[bits(32) address, integer size] = bits(8*size) value
```

AppxA.6.40MemU[]

This array-like function performs a memory access that is allowed to be unaligned, using the current privilege level.

```
bits(8*size) MemU[bits(32) address, integer size]
MemU[bits(32) address, integer size] = bits(8*size) value
```

AppxA.6.41MemU_unpriv[]

This array-like function performs a memory access that is allowed to be unaligned, as an unprivileged access regardless of the current privilege level.

```
bits(8*size) MemU_unpriv[bits(32) address, integer size]
MemU_unpriv[bits(32) address, integer size] = bits(8*size) value
```

AppxA.6.42R[]

This array-like function reads or writes a register. Reading register 13, 14, or 15 reads the SP, LR or PC respectively and writing register 13 or 14 writes the SP or LR respectively.

```
bits(32) R[integer n]
R[integer n] = bits(32) value;
```

AppxA.6.43RaiseCoproprocessorException()

This procedure raises a UsageFault exception for a rejected coprocessor instruction.

AppxA.6.44RaiseIntegerZeroDivide()

This procedure raises the appropriate exception for a division by zero in the integer division instructions SDIV and UDIV.

In the M profile, this is a UsageFault exception.

AppxA.6.45SetExclusiveMonitors()

This procedure sets the exclusive monitors for a load exclusive instruction.

```
SetExclusiveMonitors(bits(32) address, integer size)
```

AppxA.6.46Shift(), Shift_C()

These functions perform standard ARM shifts on values, returning a result value and in the case of `Shift_C()`, a carry out bit. See *Shift operations* on page A5-11.

AppxA.6.47StartITBlock()

This procedure starts an IT block with specified *first condition* and *mask* values.

```
StartITBlock(bits(4) firstcond, bits(4) mask)
```

AppxA.6.48ThisInstr()

This function returns the currently-executing instruction. It is only used on 32-bit instruction encodings at present.

```
bits(32) ThisInstr()
```

AppxA.6.49ThumbExpandImm(), ThumbExpandImmWithC()

These functions do the standard expansion of the 12 bits specifying an Thumb data-processing immediate to its 32-bit value. The `WithC` version also produces a carry out bit. See *Operation* on page A5-9.

AppxA.6.50WaitForEvent()

This procedure causes the processor to suspend execution until any processor in the multiprocessor system executes a SEV instruction, or any of the following occurs for the processor itself:

- an event signalled by another processor using the SEV (Send Event) instruction
- any exception entering the Pending state if the SEVONPEND bit is set in the System Control register.
- an asynchronous exception at a priority that pre-empts any currently active exceptions
- a Debug Event with debug enabled
- implementation-specific reasons, that might be IMPLEMENTATION DEFINED but also might occur arbitrarily
- Reset.

If the Event Register is set, Wait For Event clears it and returns immediately.

It is IMPLEMENTATION DEFINED whether or not restarting execution after the period of suspension causes a `ClearEventRegister()` to occur.

AppxA.6.51WaitForInterrupt()

This procedure causes the processor to suspend execution until any of the following occurs for that processor:

- an asynchronous exception at a priority that pre-empts any currently active exceptions
- a Debug Event with debug enabled
- implementation-specific reasons, that might be IMPLEMENTATION DEFINED but also might occur arbitrarily
- reset.

Appendix B

Legacy Instruction Mnemonics

The following table shows the pre-UAL assembly syntax used for Thumb instructions before the introduction of Thumb-2 and the equivalent UAL syntax for each instruction. It can be used to translate correctly-assembling pre-UAL Thumb assembler code into UAL assembler code.

This table is not intended to be used for the reverse translation from UAL assembler code to pre-UAL Thumb assembler code.

In this table, 3-operand forms of the equivalent UAL syntax are used, except in one case where a 2-operand form needs to be used to ensure that the same instruction encoding is selected by a UAL assembler as was selected by a pre-UAL Thumb assembler.

Table AppxB-1 Pre-UAL assembly syntax

Pre-UAL Thumb syntax	Equivalent UAL syntax	Notes
ADC <Rd>, <Rm>	ADCS <Rd>, <Rd>, <Rm>	
ADD <Rd>, <Rn>, #<imm>	ADDS <Rd>, <Rn>, #<imm>	
ADD <Rd>, #<imm>	ADDS <Rd>, #<imm>	
ADD <Rd>, <Rn>, <Rm>	ADDS <Rd>, <Rn>, <Rm>	
ADD <Rd>, SP	ADD <Rd>, SP, <Rd>	

Table AppxB-1 Pre-UAL assembly syntax

Pre-UAL Thumb syntax	Equivalent UAL syntax	Notes
ADD <Rd>, <Rm>	ADD <Rd>, <Rd>, <Rm>	If <Rd> or <Rm> is a high register and <Rm> is not SP
ADD <Rd>, PC, #<imm> ADR <Rd>, <label>	ADD <Rd>, PC, #<imm> ADR <Rd>, <label>	ADR form preferred where possible
ADD <Rd>, SP, #<imm>	ADD <Rd>, SP, #<imm>	
ADD SP, #<imm>	ADD SP, SP, #<imm>	
AND <Rd>, <Rm>	ANDS <Rd>, <Rd>, <Rm>	
ASR <Rd>, <Rm>, #<imm>	ASRS <Rd>, <Rm>, #<imm>	
ASR <Rd>, <Rs>	ASRS <Rd>, <Rd>, <Rs>	
B<cond> <label>	B<cond> <label>	
B <label>	B <label>	
BIC <Rd>, <Rm>	BICS <Rd>, <Rd>, <Rm>	
BKPT <imm>	BKPT <imm>	
BL <label>	BL <label>	
BLX <Rm>	BLX <Rm>	<Rm> can be a high register
BX <Rm>	BX <Rm>	<Rm> can be a high register
CMN <Rn>, <Rm>	CMN <Rn>, <Rm>	
CMP <Rn>, #<imm>	CMP <Rn>, #<imm>	
CMP <Rn>, <Rm>	CMP <Rn>, <Rm>	<Rd> and <Rm> can be high registers.
CPS<effect> <iflags>	CPS<effect> <iflags>	
CPY <Rd>, <Rm>	MOV <Rd>, <Rm>	
EOR <Rd>, <Rm>	EORS <Rd>, <Rd>, <Rm>	
LDMIA <Rn>!, <registers>	LDMIA <Rn>, <registers>LDMIA <Rn>!, <registers>	If <Rn> listed in <registers>Otherwise
LDR <Rd>, [<Rn>, #<imm>]	LDR <Rd>, [<Rn>, #<imm>]	<Rn> can be SP

Table AppxB-1 Pre-UAL assembly syntax

Pre-UAL Thumb syntax	Equivalent UAL syntax	Notes
LDR <Rd>, [<Rn>, <Rm>]	LDR <Rd>, [<Rn>, <Rm>]	
LDR <Rd>, [PC, #<imm>] LDR <Rd>, <label>	LDR <Rd>, [PC, #<imm>] LDR <Rd>, <label>	<label> form preferred where possible
LDRB <Rd>, [<Rn>, #<imm>]	LDRB <Rd>, [<Rn>, #<imm>]	
LDRB <Rd>, [<Rn>, <Rm>]	LDRB <Rd>, [<Rn>, <Rm>]	
LDRH <Rd>, [<Rn>, #<imm>]	LDRH <Rd>, [<Rn>, #<imm>]	
LDRH <Rd>, [<Rn>, <Rm>]	LDRH <Rd>, [<Rn>, <Rm>]	
LDRSB <Rd>, [<Rn>, <Rm>]	LDRSB <Rd>, [<Rn>, <Rm>]	
LDRSH <Rd>, [<Rn>, <Rm>]	LDRSH <Rd>, [<Rn>, <Rm>]	
LSL <Rd>, <Rm>, #<imm>	LSLS <Rd>, <Rm>, #<imm>	
LSL <Rd>, <Rs>	LSLS <Rd>, <Rd>, <Rs>	
LSR <Rd>, <Rm>, #<imm>	LSRS <Rd>, <Rm>, #<imm>	
LSR <Rd>, <Rs>	LSRS <Rd>, <Rd>, <Rs>	
MOV <Rd>, #<imm>	MOVS <Rd>, #<imm>	
MOV <Rd>, <Rm>	ADDS <Rd>, <Rm>, #0MOV <Rd>, <Rm>	If <Rd> and <Rm> are both R0-R7Otherwise
MUL <Rd>, <Rm>	MULS <Rd>, <Rm>, <Rd>	
MVN <Rd>, <Rm>	MVNS <Rd>, <Rm>	
NEG <Rd>, <Rm>	RSBS <Rd>, <Rm>, #0	
ORR <Rd>, <Rm>	ORRS <Rd>, <Rd>, <Rm>	
POP <registers>	POP <registers>	<registers> can include PC
PUSH <registers>	PUSH <registers>	<registers> can include LR
REV <Rd>, <Rn>	REV <Rd>, <Rn>	
REV16 <Rd>, <Rn>	REV16 <Rd>, <Rn>	
REVSH <Rd>, <Rn>	REVSH <Rd>, <Rn>	
ROR <Rd>, <Rs>	RORS <Rd>, <Rd>, <Rs>	

Table AppxB-1 Pre-UAL assembly syntax

Pre-UAL Thumb syntax	Equivalent UAL syntax	Notes
SBC <Rd>, <Rm>	SBCS <Rd>, <Rd>, <Rm>	
STMIA <Rn>!, <registers>	STMIA <Rn>!, <registers>	
STR <Rd>, [<Rn>, #<imm>]	STR <Rd>, [<Rn>, #<imm>]	<Rn> can be SP
STR <Rd>, [<Rn>, <Rm>]	STR <Rd>, [<Rn>, <Rm>]	
STRB <Rd>, [<Rn>, #<imm>]	STRB <Rd>, [<Rn>, #<imm>]	
STRB <Rd>, [<Rn>, <Rm>]	STRB <Rd>, [<Rn>, <Rm>]	
STRH <Rd>, [<Rn>, #<imm>]	STRH <Rd>, [<Rn>, #<imm>]	
STRH <Rd>, [<Rn>, <Rm>]	STRH <Rd>, [<Rn>, <Rm>]	
SUB <Rd>, <Rn>, #<imm>	SUBS <Rd>, <Rn>, #<imm>	
SUB <Rd>, #<imm>	SUBS <Rd>, #<imm>	
SUB <Rd>, <Rn>, <Rm>	SUBS <Rd>, <Rn>, <Rm>	
SUB SP, #<imm>	SUB SP, SP, #<imm>	
SWI <imm>	SVC <imm>	
SXTB <Rd>, <Rm>	SXTB <Rd>, <Rm>	
SXTH <Rd>, <Rm>	SXTH <Rd>, <Rm>	
TST <Rn>, <Rm>	TST <Rn>, <Rm>	
UXTB <Rd>, <Rm>	UXTB <Rd>, <Rm>	
UXTH <Rd>, <Rm>	UXTH <Rd>, <Rm>	

Appendix C

CPUID

The CPUID scheme used on ARMv7-M aligns with the revised format ARM Architecture CPUID scheme. An architecture variant of 0xF specified in The Main ID Register (CPUID<:19:16>) indicates the revised format is being used. All ID registers are privileged access only. Privileged writes are ignored, and unprivileged data accesses cause a BusFault error.

AppxC.1 Core Feature ID Registers

The Core Feature ID registers are decoded in the System Control Space as defined in Table AppxC-1.

Table AppxC-1 Core Feature ID register support in the SCS

Address	Type	Reset Value	Function
0xE000ED00	Read Only	IMPLEMENTATION DEFINED	CPUID Base Register
0xE000ED40	Read Only	IMPLEMENTATION DEFINED	PFR0: Processor Feature register0
0xE000ED44	Read Only	IMPLEMENTATION DEFINED	PFR1: Processor Feature register1
0xE000ED48	Read Only	IMPLEMENTATION DEFINED	DFR0: Debug Feature register0
0xE000ED4C	Read Only	IMPLEMENTATION DEFINED	AFR0: Auxiliary Feature register0
0xE000ED50	Read Only	IMPLEMENTATION DEFINED	MMFR0: Memory Model Feature register0
0xE000ED54	Read Only	IMPLEMENTATION DEFINED	MMFR1: Memory Model Feature register1
0xE000ED58	Read Only	IMPLEMENTATION DEFINED	MMFR2: Memory Model Feature register2
0xE000ED5C	Read Only	IMPLEMENTATION DEFINED	MMFR3: Memory Model Feature register3
0xE000ED60	Read Only	IMPLEMENTATION DEFINED	ISAR0: ISA Feature register0
0xE000ED64	Read Only	IMPLEMENTATION DEFINED	ISAR1: ISA Feature register1
0xE000ED68	Read Only	IMPLEMENTATION DEFINED	ISAR2: ISA Feature register2
0xE000ED6C	Read Only	IMPLEMENTATION DEFINED	ISAR3: ISA Feature register3
0xE000ED70	Read Only	IMPLEMENTATION DEFINED	ISAR4: ISA Feature register4

Table AppxC-1 Core Feature ID register support in the SCS

Address	Type	Reset Value	Function
0xE000ED74	Read Only	IMPLEMENTATION DEFINED	ISAR5: ISA Feature register5
0xE000ED78	Read Only	IMPLEMENTATION DEFINED	RESERVED (RAZ)
0xE000ED7C	Read Only	IMPLEMENTATION DEFINED	RESERVED (RAZ)

Two values of the version fields have special meanings:

Field[] == all 0's the feature does not exist in this device, or the field is not allocated.

Field[] == all 1's the field has overflowed, and is now defined elsewhere in the ID space.

———— **Note** —————

All RESERVED fields in the Core Feature ID registers Read-as-Zero (RAZ).

For details of the attribute registers see the technical reference manual for the ARM compliant core of interest.

—————

Appendix D

Deprecated Features in ARMv7M

Some features of the Thumb instruction set are deprecated in ARMv7. Deprecated features affecting instructions supported by ARMv7-M are as follows:

- Use of the PC as the base register in an *STC* instruction
- Use of the SP as Rm in a 16-bit *CMP* (register) instruction.

Glossary

APSR See Application Program Status Register.

Application Program Status Register

The register containing those bits that deliver status information about the results of instructions. In this manual, synonymous with the CPSR, but only the N, Z, C, V, Q and GE[3:0] bits of the CPSR are accessed using the APSR name.

Clear Relates to registers or register fields. Indicates the bit has a value of zero (or bit field all 0s), or is being written with zero or all 0s.

DCB Debug Control Block - a region within the System Control Space (see SCS) specifically assigned to register support of debug features in ARMv7-M.

DWT Data Watchpoint and Trace - mandatory block in the ARMv7-M debug architecture.

ETM Embedded Trace Macrocell - optional block in the ARMv7-M debug architecture

IMPLEMENTATION DEFINED

Means that the behavior is not architecturally defined, but must be defined and documented by individual implementations.

IT block An IT block is a block of up to four instructions following an *If-Then* (IT) instruction. Each instruction in the block is conditional. The conditions for the instructions are either all the same, or some can be the inverse of others. See *IT* on page A5-92 for additional information.

ITM Instrumentation Trace Macrocell - mandatory block in the ARMv7-M debug architecture

Memory hint

A memory hint instruction allows you to provide advance information to memory systems about future memory accesses, without actually loading or storing any data. `PLD` and `PLI` are the only memory hint instructions currently provided.

NRZ Non-Return-to-Zero - physical layer signalling scheme used on asynchronous communication ports.

Reserved

Relates to registers or register fields. The behavior is `SBZP/UNP`.

Return Link

a value relating to the return address

R/W1C register bits marked `R/W1C` can be read normally and support write-one-to-clear. A read then write of the result back to the register will clear all bits set. `R/W1C` protects against read-modify-write errors occurring on bits set between reading the register and writing the value back (since they are written as zero, they will not be cleared).

RAZ/WI Relates to registers or register fields. Read as zero, ignore writes. `RAZ` can be used on its own.

RO Read only register or register field.

SBO Relates to registers or register fields. Should be written as one (or all 1s for bit fields) by software. Values other than 1 produce `UNPREDICTABLE` results.

SBOP Relates to registers or register fields. Should be written as one (or all 1s for bit fields) to initialise the value, otherwise the value should be preserved by software.

SBZ Relates to registers or register fields. Should be written as zero (or all 0s for bit fields) by software. Non-zero values produce `UNPREDICTABLE` results.

SBZP Relates to registers or register fields. Should be written as zero (or all 0s for bit fields) to initialise the value, otherwise the value should be preserved by software.

SBZP/UNP

Relates to registers or register fields. Should be written as zero (or all 0s for bit fields) to initialise the value, otherwise the value should be preserved by software. Failing to do this produces `UNPREDICTABLE` results. Software must not rely on the value read.

SCB System Control Block - an address region within the System Control Space used for key feature control and configuration associated with the exception model.

SCS System Control Space - a 4kB region of the memory map reserved for ARMv7-M system control and configuration.

Set Relates to registers or register fields. Indicates the bit has a value of 1 (or bit field all 1s), or is being written with 1 or all 1s, unless explicitly stated otherwise.

SWO Single Wire Output - an asynchronous TPIU port supporting `NRZ` and/or Manchester encoding.

SWV Single Wire Viewer - the combination of an `SWO` and `DWT/ITM` data tracing capability

Thumb-2

the support of 16-bit and 32-bit atomic instruction execution in Thumb state

TPIU Trace Port Interface Unit - optional block in the ARMv7-M debug architecture

UAL See Unified Assembler Language.

UNDEFINED

An attempt to execute an UNDEFINED instruction causes an Undefined Instruction exception.

Unified Assembler Language

The new assembler language used in this document. See *Unified Assembler Language* on page xi for details.

UNKNOWN

The value associated with a bit field, register or memory resource is not known when it is read or updated. No other side-effects occur.

UNPREDICTABLE

The result of an UNPREDICTABLE instruction cannot be relied upon. UNPREDICTABLE instructions or results must not represent security holes. UNPREDICTABLE instructions must not halt or hang the processor, or any parts of the system.

WO Write only register or register field.

WYSIWYG

What You See Is What You Get, an acronym for describing predictable behavior of the output generated. Display to printed form and software source to executable code are examples of common use.

